

CLB-Series

THERMAL CIRCUIT PROTECTORS

Rating:

3 to 60A, 125-250VAC, 32VDC

Approvals:

UL, CUL, CSA, TUV, CE
 UL1500/ISO8846 for ignition protection/marine

Dielectric Strength:

2500 VAC/1 minute

Interrupting capacity:

2500 amps @ 32 VDC

Insulation Resistance:

100M ohms

Operating Temperature:

-10°C to 60°C

Voltage drop:

< 0.25 V

Applications:

Household Appliances
 Transportation
 Marine
 Power Strips
 Medical Equipment
 Audio Visual Equipment
 Power Supplies

ROHS Compliant



A COMPACT, SINGLE POLE, PUSH-TO-RESET FAMILY OF THERMAL CIRCUIT BREAKERS

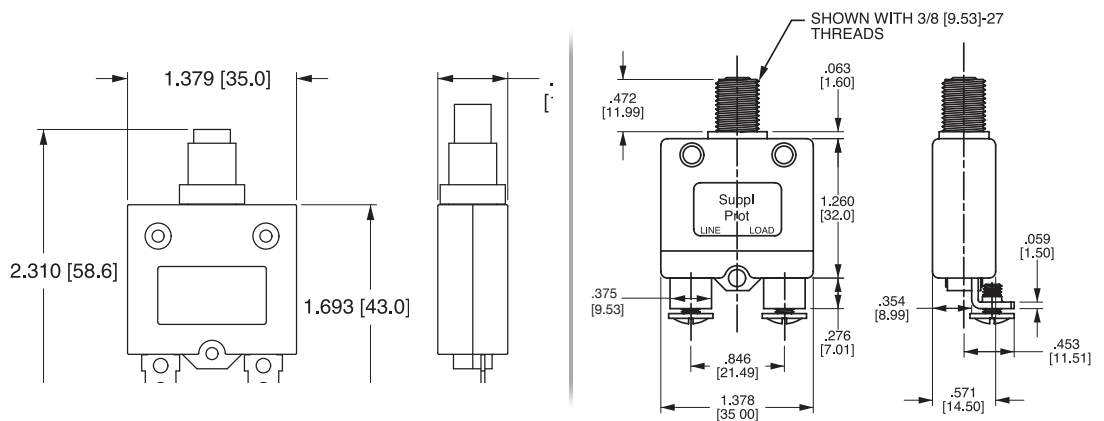

Carling Technologies™

Innovative Designs. Powerful Solutions.

Carling Technologies, Inc.

60 Johnson Avenue, Plainville, CT 06062

Email: sales@carlingtech.com

Application Support: team2@carlingtech.com

Phone: 860.793.9281 Fax: 860.793.9231

www.carlingtech.com

CLB - 10 3 - 12 C 3 N - B - A / 10

1 Series 2 Rating 3 Voltage 4 Mounting Hole 5 Bushing Type 6 Mounting Nut 7 Indicator Plate 8 Button 9 Terminal 10 Button Marking

1 SERIES CLB

3 VOLTAGE 3 125-250VAC/ 32 VDC

2 RATING

03	3 amp	15	15 amp
04	4 amp	18	18 amp
05	5 amp	20	20 amp
06	6 amp	25	25 amp
07	7 amp	30	30 amp
08	8 amp	35	35 amp
10	10 amp	40	40 amp
12	12 amp	50 ¹²	50 amp
13	13 amp	60 ¹²	60 amp

4 MOUNTING HOLE

- 11¹ M11
- 12² M12
- 00³ Snap In Style
- 27⁴ 3/8" 27 UNS

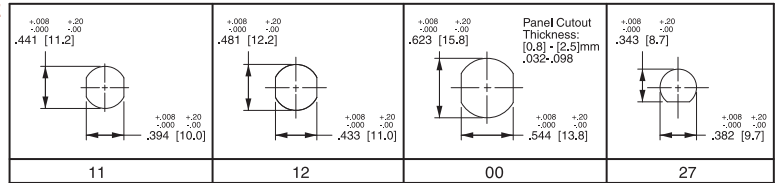

5 BUSHING

METAL

- A⁵ Type A
- B⁶ Type B
- J⁸ Type J

PLASTIC

- C⁵ Type C
- D⁷ Type D
- E⁸ Type E

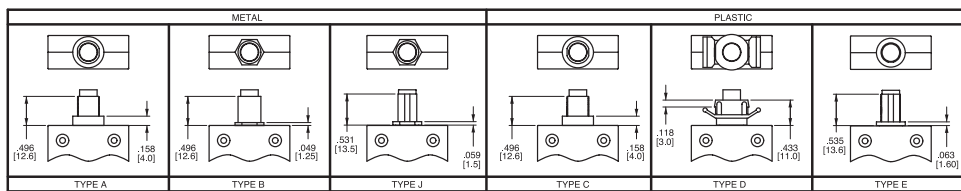

6 MOUNTING NUT⁹

- N None
- 1 Type 1
- 2 Type 2
- 3 Type 3
- 4 Type 4
- 5 Type 5
- 6^{4,14} Type 6
- 7⁴ Type 7
- 8⁴ Type 8

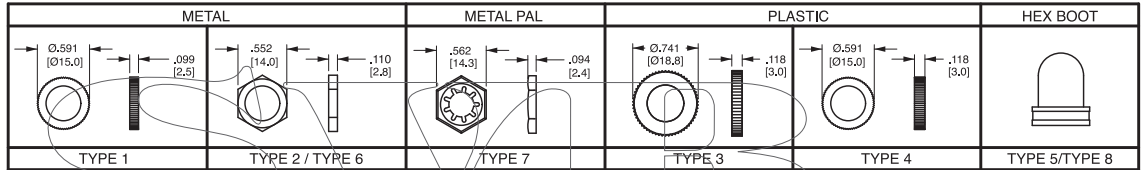

NOTE: Type 5 is clear hex boot. Type 8 is black hex boot (available for bushings E & J only); Type 3 nut includes rhoid in "PRESS TO RESET" marking.

7 INDICATOR PLATE⁹

- N None
- A Embossed
- B Silver Printing on Black

All indicator plates are marked "Suppl. Prot. press to reset".

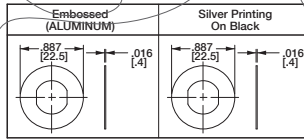

Notes: All dimensions are in [mm]. Tolerance ± 0.05 [.127] unless otherwise specified.

- 1 Used with bushing A or B only.
- 2 Used with bushing C only.
- 3 Used with bushing D only.
- 4 Used with bushing E & J only.
- 5 Used with M12 mounting hole only.
- 6 Used with M11 mounting hole only.
- 7 Used with mounting hole 00 only.
- 8 Used with 27 mounting hole only.
- 9 All hardware available separately. Consult factory.
- 10 > 35 amp ratings must use solder joint to connect wire to non-screw type terminals.
- 11 Terminals are .040 [1.0] thickness for ratings > 35 & .315 [8] thickness is for ratings < 35 amps.
- 12 Available only with 10-24 unc. screw terms. (select type F, G, H, J only.) UL, CUL only.
- 13 Amp rating must match button marking (ex: "20" will be marked on the button of the breaker)
- 14 Thickness is 3.0 mm, .118 in.
- 15 Screw terminals are 8-32 UNC

8 BUTTON

- B Black R Red W White

9 TERMINAL^{10,11,15}

- A Type A
- B Type B
- C Type C
- D Type D
- E Type E
- F Type F
- G Type G
- H Type H
- J Type J

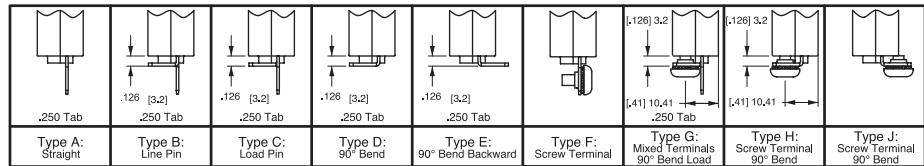

10 BUTTON MARKING (IF BLANK, NO MARKING.)¹³ Button Marking Orientation: line (20) load

03	3 amp	06	6 amp	10	10 amp	15	15 amp	25	25 amp	40	40 amp
04	4 amp	07	7 amp	12	12 amp	18	18 amp	30	30 amp	50	50 amp
05	5 amp	08	8 amp	13	13 amp	20	20 amp	35	35 amp	60	60 amp

Time Delay

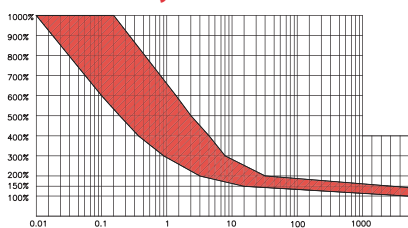

*Manufacturer reserves the right to change product specification without prior notice.

DERATING FACTOR	
-10°C	X1.70
-5°C	X1.60
0°C	X1.50
5°C	X1.40
10°C	X1.30
15°C	X1.20
20°C	X1.10
25°C	X1.00

DERATING FACTOR	
30°C	X0.90
35°C	X0.85
40°C	X0.80
45°C	X0.75
50°C	X0.70
55°C	X0.65
60°C	X0.60

OVERLOAD	TRIP TIME
100 %	NO TRIP
150 %	TRIP IN 1 HR
200 %	4.0~40 sec
300 %	0.9~8.0 sec
400 %	0.42~5.0 sec
500 %	0.25~3.0 sec
600 %	0.1~1.8 sec

Notes:

Breaker must hold 100% of rated current and must trip at 150% and above, within the time limits shown in curve. Trip times specified at 25° ambient with no preloading.

- 1 To adjust the breaker rating for ambient temperature multiply the breaker rating by the factor. (ex: 5 amp rating at 0°C: 5 x .67 = 3.3 amp. Select 3 amp rating.)