











PC-F1A Self tapping female (page 1 of 2)

| | | | | | | | |
|-----------------------------------------------------------------------------------|--------------------------------------------------------------------------------------------------------------------------------------------------------------------------------------------|--------------------------------------------------------------------------------------------------------------------------------------------------------------------------------------------|---------------------------------------------------------------------------------------------------------------------------------------------------------------------------------------------|----------------------------------------------------------------------------------------------|----------------------------------------------------------------------------------------------|----------------------------------------------------------------------------------------------|----------------------------------------------------------------------------------------------|
|  | USE WITH: | | | INSTALL WITH: | | | |
| | PC-M1B  PC-M2H  | PC-VM1  PC-VMX  | PC-SM2  PC-SM2H  | CT-01  | CT-03  | CT-07  | CT-10  |
| INSTALLATION STEPS <small>(see reverse for more options)</small> | | | | | | | |





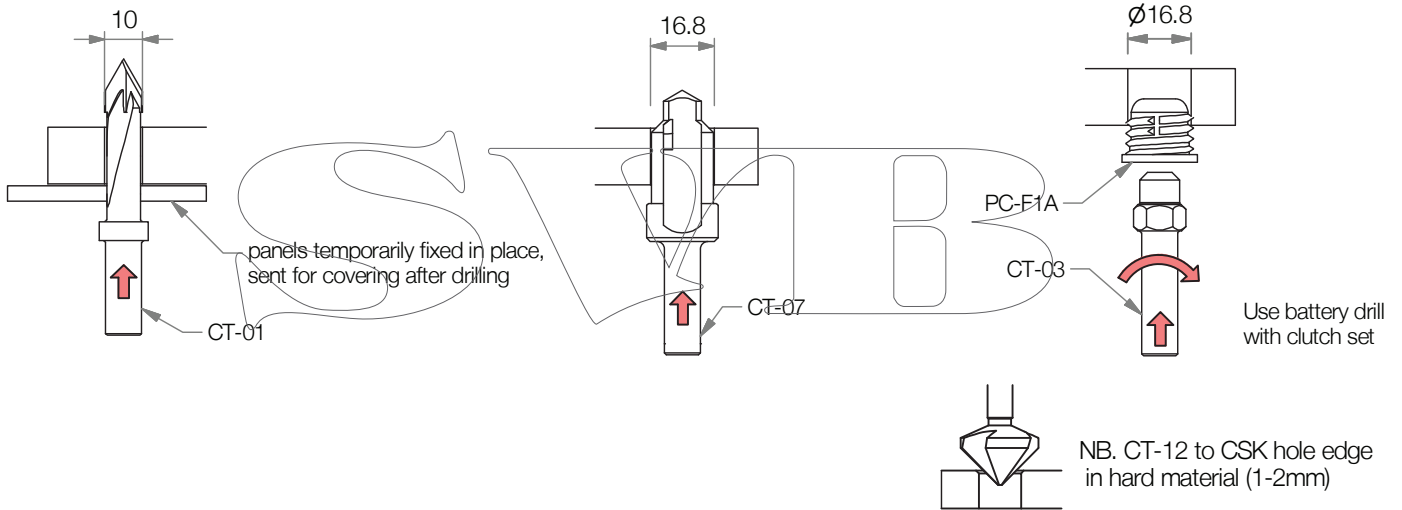

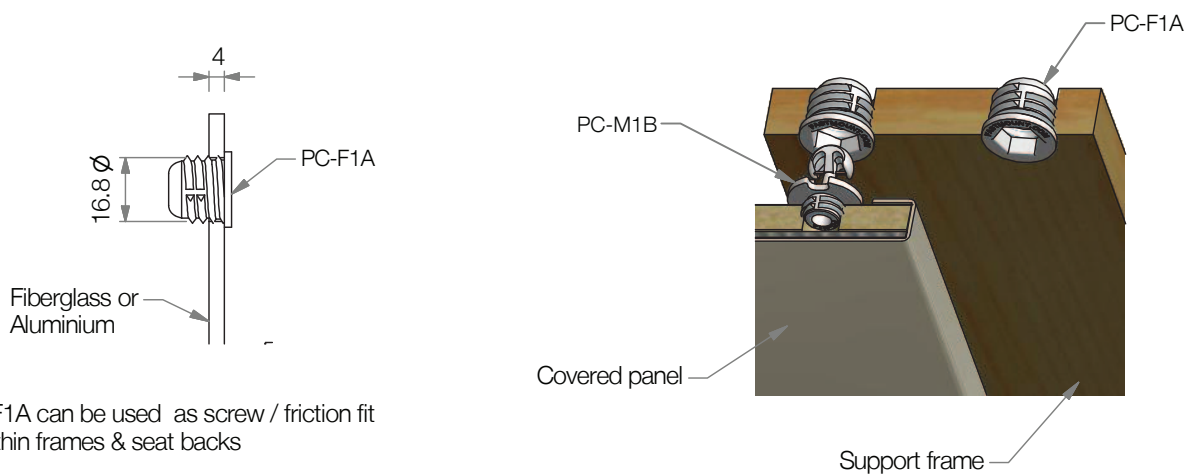



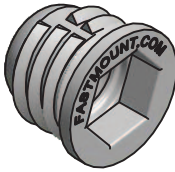

- 1 Drill hole through panel & frame
- 2 Drill out frame hole with CT-07
- 3 Screw fit PC-F1 with CT-03



- 4 Screw fit PC-F1 into thin frame
- 5 Cutaway view showing panel mounting



PC-F1A Self tapping female (page 2)

| | | | | | | | |
|-----------------------------------------------------------------------------------|---------------------------------------------------------------------------------------------|---------------------------------------------------------------------------------------------|----------------------------------------------------------------------------------------------|-----------------------------------------------------------------------------------------------------|----------------------------------------------------------------------------------------------|----------------------------------------------------------------------------------------------|----------------------------------------------------------------------------------------------|
|  | USE WITH: | | | INSTALL WITH: | | | |
| | PC-M1B  | PC-VM1  | PC-SM2  | CP-01A  | CT-07  | CT-09  | CT-10  |
| | PC-M2H  | PC-VMX  | PC-SM2H  | or CP01ST  | | | |

INSTALLATION STEPS (continued from previous page)

1 Fit CP-01A into PC-F1A then push panel to mark center

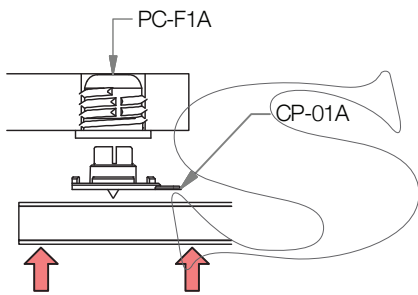

2 Drill panel on center mark with CT-09 7.5mm deep for PC-M2H

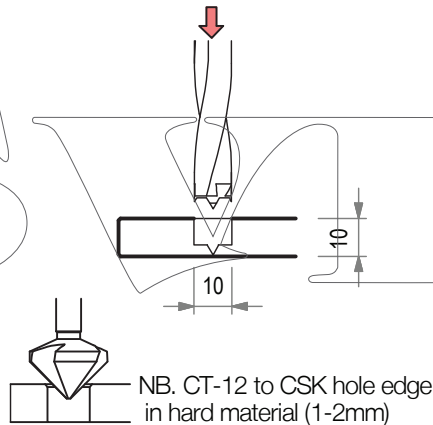

3 Screw fit male clip with CT-10

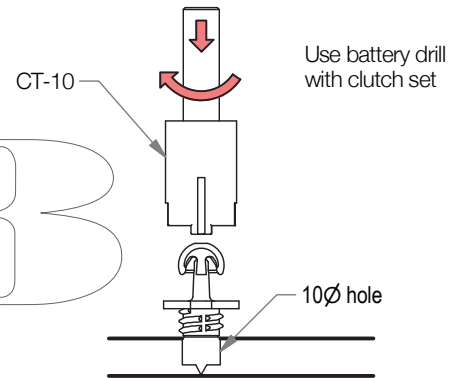

INSTALLING ADHESIVE FIT MALE CLIPS (first complete steps 1 to 3, page 1)

4 Clip PC-SM2 into PC-F1A

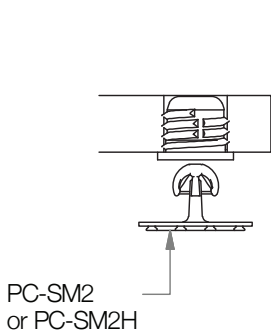

5 Apply adhesive to PC-SM2

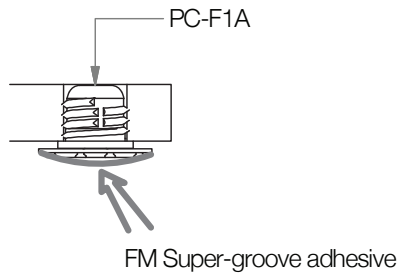

6 Place panel & support while adhesive dries

