

B&G

Vulcan Series Operator Manual

ENGLISH



Preface

Disclaimer

As Navico is continuously improving this product, we retain the right to make changes to the product at any time which may not be reflected in this version of the manual. Please contact your nearest distributor if you require any further assistance.

It is the owner's sole responsibility to install and use the equipment in a manner that will not cause accidents, personal injury or property damage. The user of this product is solely responsible for observing safe boating practices.

NAVICO HOLDING AS AND ITS SUBSIDIARIES, BRANCHES AND AFFILIATES DISCLAIM ALL LIABILITY FOR ANY USE OF THIS PRODUCT IN A WAY THAT MAY CAUSE ACCIDENTS, DAMAGE OR THAT MAY VIOLATE THE LAW.

Governing Language: This statement, any instruction manuals, user guides and other information relating to the product (Documentation) may be translated to, or has been translated from, another language (Translation). In the event of any conflict between any Translation of the Documentation, the English language version of the Documentation will be the official version of the Documentation.

This manual represents the product as at the time of printing. Navico Holding AS and its subsidiaries, branches and affiliates reserve the right to make changes to specifications without notice.

Trademarks

B&G[®] is a registered trademark of Navico Holding AS.

Navionics[®] is a registered trademark of Navionics, Inc.

NMEA[®] and NMEA 2000[®] are registered trademarks of the National Marine Electronics Association.

SiriusXM[®] is a registered trademark of Sirius XM Radio Inc.

Fishing Hot Spots[®] is a registered trademark of Fishing Hot Spots Inc. Copyright© 2012 Fishing Hot Spots.

FUSION-Link[™] Marine Entertainment Standard[™] is a registered trademark of FUSION Electronics Ltd.

C-MAP[®] is a registered trademark of C-MAP.

SD™ and microSD™ are trademarks or registered trademarks of SD-3C, LLC in the United States, other countries or both.

Additional mapping data: Copyright© 2012 NSI, Inc.: Copyright© 2012 by Richardson's Maptech.

Bluetooth® is a registered trademark of Bluetooth SIG, Inc.

Navico product references

This manual can refer to the following Navico products:

- Broadband Sounder™ (Broadband Sounder)
- DownScan Imaging™ (DownScan)
- DownScan Overlay™ (Overlay)
- ForwardScan™ (ForwardScan)
- GoFree™ (GoFree)
- INSIGHT GENESIS® (Insight Genesis)
- StructureMap™ (StructureMap)
- StructureScan® (StructureScan)
- StructureScan® HD (StructureScan HD)

Copyright

Copyright © 2017 Navico Holding AS.

Warranty

The warranty card is supplied as a separate document.

In case of any queries, refer to the brand website of your display or system: www.bandg.com.

Internet usage

Some features in this product use an internet connection to perform data downloads and uploads. Internet usage via a connected mobile/cell phone internet connection or a pay-per-MB type internet connection may require large data usage. Your service provider may charge you based on the amount of data you transfer. If you are unsure, contact your service provider to confirm rates and restrictions.

Compliance statements

This equipment complies with:

- CE under 2014/53/EU Directive
- The requirements of level 2 devices of the Radio communications (Electromagnetic Compatibility) standard 2008
- Part 15 of the FCC Rules. Operation is subject to the following two conditions: (1) this device may not cause harmful interference, and (2) this device must accept any interference received, including interference that may cause undesired operation.

The relevant Declaration of conformity is available in the product's section at the following website: www.bandg.com.

About this manual

This manual is a reference guide for operating Vulcan Series units. It assumes that all equipment is installed and configured, and that the system is ready to use.

The manual assumes that the user has basic knowledge of navigation, nautical terminology and practices.

Important text that requires special attention from the reader is emphasized as follows:

→ **Note:** Used to draw the reader's attention to a comment or some important information.

⚠ **Warning:** Used when it is necessary to warn personnel that they should proceed carefully to prevent risk of injury and/or damage to equipment/personnel.

Manual version

This manual is written for software version 2.1. The manual is continually updated to match new software releases. The latest available manual version can be downloaded from www.bandg.com.

Viewing the manual on the screen

The PDF viewer included in the unit makes it possible to read the manuals and other PDF files on the screen. Manuals can be downloaded from www.bandg.com.

The manuals can be read from a card inserted in the card reader or copied to the unit's internal memory.

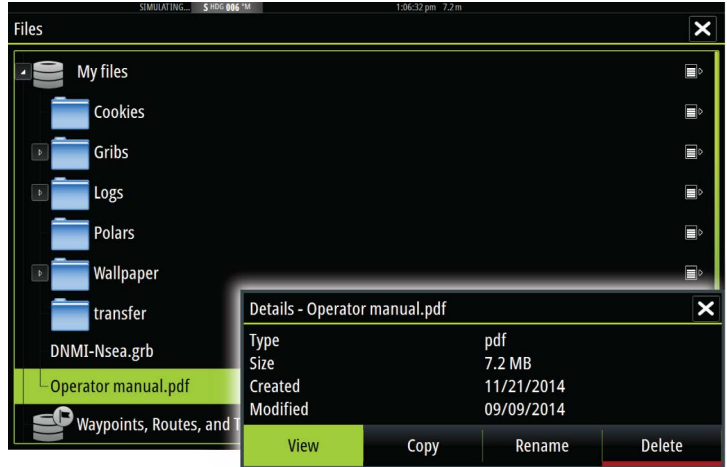

Use the menu options and on-screen buttons to maneuver in the PDF file as described below:

- Search, Goto page, Page Up and Down
Select the relevant panel button.
- Scroll pages
Drag finger on the screen in any direction.
- Panning on the page
Drag finger on the screen in any direction.
- Zoom In/Out
Select the relevant panel button.
Touch operation: Use pinch or spread gestures.
- Exit the PDF viewer
Select the **X** in the upper right corner of the panel.

The Software version

The software version currently on this unit can be found in the About dialog. The About dialog is available in the System Settings.

For information regarding upgrading your software, refer to *"Software upgrades"* on page 206.

Contents

13 Introduction

- 13 The Home page
- 14 Application pages
- 16 Feature unlock
- 16 Integration of 3rd party devices
- 18 H5000 integration
- 18 Remote controllers

19 Basic operation

- 19 System Controls dialog
- 19 Turning the system on and off
- 20 Display illumination
- 20 Wireless
- 20 Locking the touchscreen
- 21 Instrument bar
- 21 Using menus and dialogs
- 21 Selecting pages and panels
- 22 Displaying the Favorites panel as a pop-up on a page
- 22 Creating a Man Overboard waypoint
- 23 Screen capture

24 Customizing your system

- 24 Customizing the Home page wallpaper
- 24 Adjusting panel size
- 25 Customizing the long press feature
- 25 Password protection
- 26 Adding new favorite pages
- 27 Edit favorite pages
- 27 Setting the appearance of the Instrument bar

29 Charts

- 29 The Chart panel
- 30 Chart data
- 30 Showing dual chart types
- 31 Vessel symbol
- 31 Chart scale
- 31 Panning the chart
- 31 Positioning the vessel on the chart panel

- 32 Displaying information about chart items
- 33 Using the cursor on the chart panel
- 34 Measuring distance
- 34 Saving waypoints
- 35 Creating routes
- 35 Find objects on chart panels
- 35 3D charts
- 36 Color tracks based on data
- 38 Chart overlay
- 38 PredictWind weather and routing
- 38 Insight and C-MAP charts
- 44 Navionics charts
- 50 Chart settings

56 Waypoints, Routes, and Tracks

- 56 Waypoints
- 58 Routes
- 65 Tracks
- 66 Waypoints, Routes, and Tracks dialogs

67 Navigating

- 67 Navigate to cursor position
- 67 Navigate a route
- 68 Navigating with the autopilot
- 69 Navigation settings

71 SailSteer panel

- 72 Selecting data fields for the SailSteer panel
- 72 Sail Time calculations
- 73 SailSteer overlay

74 Race panel

- 74 Display options
- 74 Start Line on Chart panel
- 75 Start Line Data panel
- 76 Setting up a start line
- 78 Removing end points and the start line
- 79 Start Line display
- 80 Settings
- 80 What if?

81	Race timer
84	Time and Wind plots
84	The Time plot panel
85	Wind Plot panel
86	PredictWind
86	PredictWind weather
92	PredictWind weather routing and departure planner
98	Autopilot
98	Safe operation with the autopilot
98	Activating the autopilot
98	Switching from automatic mode to manual steering
99	Autopilot indication on the pages
100	The Autopilot panel
101	Autopilot modes
101	Standby mode
101	Non-Follow Up (NFU, Power steering)
102	Follow-up steering (FU)
102	AUTO mode (Heading hold)
103	NoDrift mode
104	NAV mode
106	WIND mode
107	Autopilot settings
114	Radar
114	The radar panel
115	Dual radar
115	Radar overlay
116	Radar operational modes
117	Radar Range
117	Using the cursor on a radar panel
118	Saving waypoints
118	Adjusting the radar image
120	Advanced radar options
121	Radar view options
127	EBL/VRM markers
128	Setting a guard zone around your vessel
129	MARPA targets

- 130 Recording radar data
- 131 Radar settings

133 Echosounder

- 133 The Echosounder image
- 133 Zooming the image
- 134 Using the cursor on the image
- 135 Saving waypoints
- 135 Viewing history
- 136 Setting up the image
- 138 Advanced options
- 138 Start recording log data
- 140 Stop recording log data
- 141 Echosounder View options
- 143 Echosounder settings

145 StructureScan

- 145 The StructureScan image
- 146 Zooming the StructureScan image
- 146 Using the cursor on the StructureScan panel
- 147 Saving waypoints
- 148 Viewing StructureScan history
- 148 Setting up the StructureScan image
- 149 Advanced StructureScan settings

151 StructureMap

- 151 The StructureMap image
- 151 Activating Structure overlay
- 152 StructureMap sources
- 153 StructureMap tips
- 153 Recording StructureScan data
- 154 Using StructureMap with mapping cards
- 154 Structure options

156 ForwardScan

- 156 The ForwardScan image
- 157 Setting up the ForwardScan image
- 157 ForwardScan view options
- 158 Heading extension
- 159 ForwardScan setup

162 Wireless connection

- 162 Connect and disconnect from a wireless hotspot
- 163 GoFree Shop
- 163 GoFree Link
- 165 Uploading log files to Insight Genesis
- 165 Wireless settings

168 AIS

- 168 AIS target symbols
- 169 Viewing information about AIS targets
- 170 Calling an AIS vessel
- 170 AIS SART
- 172 Vessel alarms
- 173 Vessel settings

176 Instrument panels

- 176 Dashboards
- 176 Customizing the Instruments panel

178 Audio

- 178 Enabling audio
- 179 SonicHub 2
- 182 The Audio controller
- 185 Setting up the audio system
- 186 Operating the audio system
- 186 Favorite channels
- 186 Sirius radio (North America only)

188 Weather

- 188 Wind barbs
- 188 Showing weather details
- 189 GRIB weather
- 191 PredictWind weather and routing
- 192 SiriusXM weather

198 Alarms

- 198 Alarm system
- 198 Type of messages

- 198 Single alarms
- 198 Multiple alarms
- 199 Acknowledging a message
- 199 Alarms dialog

201 Tools

- 201 Waypoints/routes/tracks
- 201 Tides
- 201 Alarms
- 201 Settings
- 201 Vessels
- 202 Sun, Moon
- 202 Trip calculator
- 202 Files
- 202 Find
- 202 GoFree Shop

204 Simulator

- 204 Demo mode
- 204 Simulator source files
- 205 Advanced simulator settings

206 Maintenance

- 206 Preventive maintenance
- 206 Cleaning the display unit
- 206 Cleaning the media port door
- 206 Checking the connectors
- 206 Software upgrades
- 208 Backing up your system data

211 Touchscreen operation

1

Introduction

The Home page

The **Home** page is accessed from any operation by selecting the **Home** button in the upper left corner of a panel.

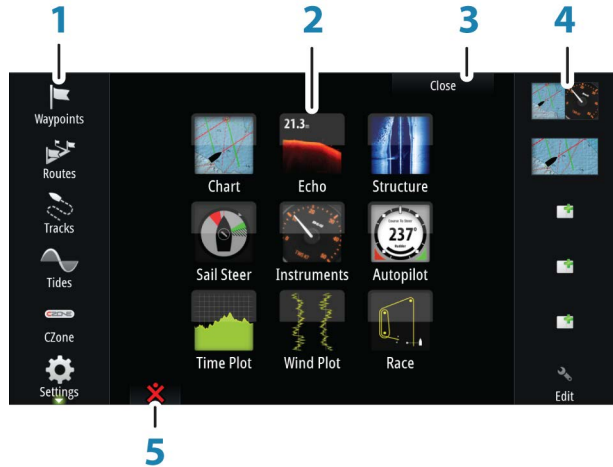

1 Tools

Select a button to access dialogs used for carrying out a task, or for browsing stored information.

2 Applications

Select a button to display the application as a full page panel. Press and hold a button to display pre-configured split page options for the application.

3 Close button

Select to exit the Home page and return to the previous active page.

4 Favorites

Select a button to display the panel combination. Press and hold a favorite button to enter edit mode for the Favorites panel.

5 Man Over Board (MOB) button

Select to save a Man Over Board (MOB) waypoint at the current vessel position.

Application pages



Each application connected to the system is presented on panels. The application can be presented as a full page, or in combination with other panels in a multiple panel page.

All application pages are accessed from the **Home** page.

1 Application panel

2 Instrument bar

Navigation and sensor information. The bar can be turned off and it can be configured by the user.

3 System controls dialog

Quick access to basic system settings.

Display the dialog by a short press on the **Power** key or by swiping down from top of the screen.

4 Status bar

5 Dialog

Information to or input from the user.

6 Control bar

Select a feature button to display controls for it.

7 Alarm message

Displayed if dangerous situations or system faults occur.

8 Menu

Panel specific menu.

Display the menu by selecting the **MENU** panel button.

Control bar

Displays buttons for features that are available on the unit. Select a Control bar button to open the controller for the feature. Selecting the same button closes the open controller. Selecting a different Control bar button closes the open controller and opens the selected controller.

Split pages

On each page you can have up to 2 panels on 5" units and up to 4 panels on larger units.



Panel sizes in a split page can be adjusted from the **System Controls** dialog.

Using the cursor on a split screen

When using the cursor on the sonar or structure image on a sonar/structure or sonar/chart split screen, the cursor is shadowed on the other split screen.

Pre-configured split pages

Each full screen application has several pre-configured split pages, featuring the selected application combined with each of the other panels.

→ **Note:** The number of pre-configured split pages cannot be changed, and the pages cannot be customized or deleted.

Access a pre-configured split page by pressing and holding the main panel button.

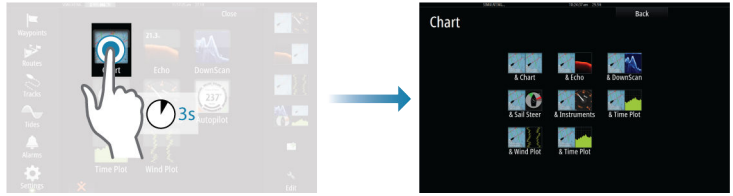

Favorite pages

All preconfigured favorite pages can be modified and deleted, and you can create your own. You can have a total of 12 favorite pages. For more information, refer to *"Adding new favorite pages"* on page 26.

Feature unlock

Features can be unlocked by entering the feature unlock code.

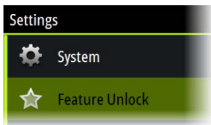

→ **Note:** The Feature Unlock option is only available if your unit supports a locked feature.

Select the Feature Unlock option in the Settings dialog and then the feature you want to unlock. Follow the instructions to purchase and enter the feature unlock code.

After a feature unlock code is entered in the unit, the feature is available for use.

Integration of 3rd party devices

Several 3rd party devices can be connected to the Vulcan Series. The applications are displayed on separate panels or integrated with other panels.

A device connected to the NMEA 2000 network should automatically be identified by the system. If not, enable the feature from the advanced option in the System settings dialog.

The 3rd party device is operated by using menus and dialogs as on other panels.

This manual does not include specific operation instructions for any 3rd party device. For features and functionality, refer to the documentation included with the 3rd party device.



SmartCraft VesselView integration

SmartCraft data can be displayed and interaction are enabled through the unit when a Mercury VesselView® 4, 7, 403, 502, 702, 703, or Link is present on the network.

The Mercury icon appears on the **Home** page when a device is available. Mercury and Vessel Control buttons are also available on the Control bar. Selecting the Mercury control bar button displays engine and vessel data, selecting the Vessel Control button displays engine controls associated with VesselView.

When the features are enabled, the display may prompt the user for some basic configuration information.

For more information about configuration information, the Mercury application page, the Mercury engine and vessel data displayed, and the Vessel Control controller, refer to the VesselView® manual or engine supplier.

FUSION-Link integration

FUSION-Link devices connected to the NMEA 2000 network can be controlled from the Vulcan Series system.

The FUSION-Link devices appear as additional sources when using the audio function. No additional icons are available.

Refer to "*Audio*" on page 178 for more information.

BEP CZone integration



The Vulcan Series integrates with BEP's CZone system used for controlling and monitoring a distributed power system on your vessel.

The CZone icon is available in the Tools panel on the **Home** page when a CZone system is available on the network.

A separate manual is provided with your CZone system. Refer to this documentation and to the Vulcan Series Installation manual for how to install and configure the CZone system.

CZone dashboard

When the CZone is installed and configured, an additional CZone dashboard is added to the Instruments panels.

You switch between a panel's dashboards by selecting the left and right arrow symbols or by selecting the dashboard from the menu.

Editing a CZone dashboard

You can customize a CZone dashboard by changing the data for each of the gauges. Available editing options depend on the type of gauge and which data sources that are connected to your system.

For more information, refer to *"Instrument panels"* on page 176.

H5000 integration



The unit integrates with B&G's H5000 Instrument and Autopilot system.

The H5000 icon will be available in the **Tools** panel on the **Home** page when an H5000 system is available on the network.

Separate documentation is provided with the H5000 system. Refer to this documentation for how to install and configure the H5000 system.

Remote controllers

You can connect a remote controller to the network and remotely control the unit. To find out which remote controllers can be used, refer to the product web page at:

www.bandg.com.

A separate manual is included with the remote controller.

2

Basic operation

System Controls dialog

The System Controls dialog provides quick access to basic system settings. You display the dialog by making a short press on the **Power** key or by swiping down from the top of the screen.

The icons displayed on the dialog can vary. For example, the adjust splits option is only available if you are viewing a split page when you open the **System Controls** dialog.



Activating functions

Select the icon of the function you want to set or toggle on or off. For those functions that toggle on and off, a highlighted icon indicates the function is activated, as shown in the Instrument bar icon above.

Turning the system on and off

You turn the system on and off by pressing and holding the **Power** key. You can also turn the unit off from the **System Controls** dialog.

If the **Power** key is released before the shut-down is completed, the power off process is cancelled.

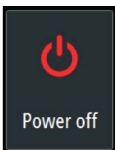



Standby mode

In Standby mode, the Sonar and the backlight for screen and keys are turned off to save power. The system continues to run in the background.

You select Standby mode from the **System Controls** dialog.

Switch from Standby mode to normal operation by a short press on the **Power** key.



Display illumination

Brightness

The display backlighting can be adjusted at any time from the **System Controls** dialog.

You can also cycle the preset backlight levels by short presses on the **Power** key.

Night mode

The night mode option optimizes the color palette and backlight for low light conditions.

→ **Note:** Details on the chart may be less visible when the Night mode is selected!

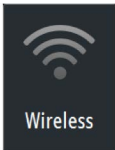

Wireless

Provides wireless connection options dependent on the status of the wireless. For example, connect to a hotspot or change to access point. For option explanations refer to "*Wireless connection*" on page 162.

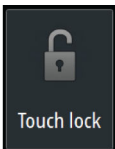

Locking the touchscreen

You can temporarily lock a touchscreen to prevent accidental operation of the system. Lock the touchscreen when large amounts of water are on the screen, for example, in heavy seas and weather. This feature is also useful when cleaning the screen while the unit is turned on.

You lock the touchscreen from the **System Controls** dialog.

You remove the lock function by a short press on the **Power** key.



Instrument bar

Toggles the Instrument bar on/off for the current page only.

Using menus and dialogs

Menus

You display a page menu by selecting the **MENU** button in the upper right corner of the page.

- Activate a menu item and toggle on/off an option by selecting it
- Adjust a slide bar value by either:
 - dragging the slide bar
 - selecting the **+** or **-** icons

Select the **Back** menu option to return to the previous menu level, and then exit.

You can make the menu slide away by tapping the screen outside the menu area, or by pressing the **MENU** button. When you re-press the **MENU** button, the menu opens in the same status it had before it closed.

The status of the cursor (active vs. inactive) changes the menu options.

Dialog boxes

Numeric and alphanumeric keyboards are automatically displayed when required for entering user information in dialogs.

A dialog is closed by saving or cancelling the entry.

A dialog can also be closed by selecting the **X** in the dialog's upper right corner.

Selecting pages and panels

Selecting a page

- Select a full page panel by selecting the relevant application button on the **Home** page
- Select a favorite page by selecting the relevant favorite button
- Select a predefined split panel by pressing and holding the relevant application icon

Select active panel

In a multiple panel page, only one panel can be active at a time. The active panel is outlined with a border.

You can only access the page menu of an active panel.

You activate a panel by tapping it.

Displaying the Favorites panel as a pop-up on a page

You can display the Favorites panel as a pop-up on any page by pressing and holding the **Home** key.

Select a favorites page in the pop-up to display it. The panel will switch to the selected favorite after 3 seconds.

Creating a Man Overboard waypoint

If an emergency situation should occur, you can create a Man Overboard (MOB) waypoint at the vessel's current position by selecting the **MOB** button on the **Home** page.

When you activate the MOB function the following actions are automatically performed:

- a MOB waypoint is created at the vessel's position
- the display switches to a zoomed chart panel, centered on the vessel's position
- the system displays navigation information back to the MOB waypoint

Multiple MOB waypoints are saved by repeatedly pressing the **MOB** buttons. The vessel continues to show navigation information to the initial MOB waypoint. Navigation to subsequent MOB waypoints needs to be done manually.

Cancel navigation to MOB

The system continues to display navigational information towards the MOB waypoint until you cancel the navigation from the menu.

Delete a MOB waypoint

1. Select the MOB waypoint to activate it
2. Select the MOB waypoint's pop-up to display the MOB waypoint dialog
3. Select the delete option in the dialog.

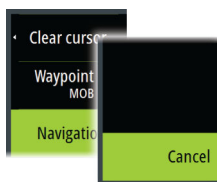

A MOB waypoint can also be deleted from the menu when it is activated.

Screen capture

You need to turn on the Screen capture option in the System Settings dialog to be able to take a screenshot on a touch screen. When the function is activated, you can take a screenshot on a touch screen by double-selecting the title bar of an open dialog, or by double-selecting the status bar if no dialog is open.

To view files, refer to *"Files"* on page 202.

3

Customizing your system

Customizing the Home page wallpaper

The Home page's wallpaper can be customized. You can select one of the pictures included with the system, or you can use your own picture in .jpg or .png format.

The images can be available on any location that can be seen in the files browser. When a picture is chosen as the wallpaper, it is automatically copied to the Wallpaper folder.

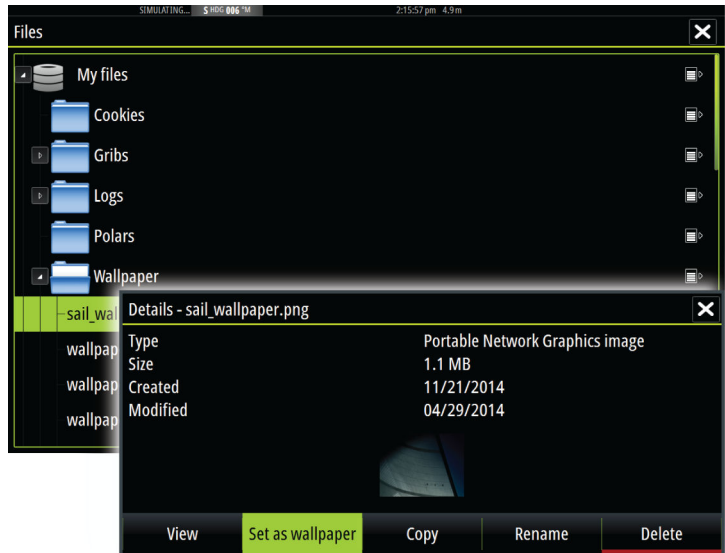
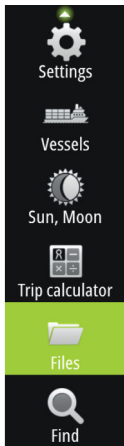

Adjusting panel size

You can change the panel size for an active split page. The panel size can be adjusted for both favorite pages and for predefined split pages.

1. Activate the **System Controls** dialog
2. Select the adjust splits option in the dialog
3. Adjust the panel size by dragging the adjustment icon
4. Confirm your changes by tapping one of the panels or selecting the save option in the menu.

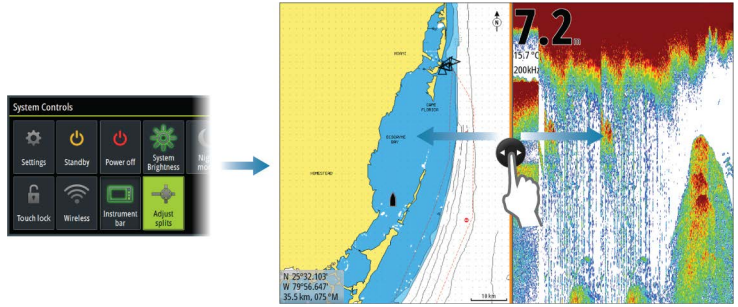

The changes are saved to the active favorite or split page.

Customizing the long press feature

Use the **Advanced settings** dialog to specify if the long press on the panel opens the menu or displays the cursor assist feature on the panel.



Password protection

You can set a PIN code to prevent unauthorized access to your system settings.

Note: We recommend you record the PIN code (password) and store it in a safe place if you use this feature.

When you establish password protection, the PIN code must be entered when any of the following are selected. After the correct PIN code is entered, all of them can be accessed without re-entering the PIN code.

- Settings, activated from the Tools panel or System Controls dialog
- Alarms, activated from the Tools panel
- Files, activated from the Tools panel
- GoFree Shop, activated from the Tools panel
- Settings, activated from the Chart menu under Chart Options

You set and remove password protection from the system Settings dialog.

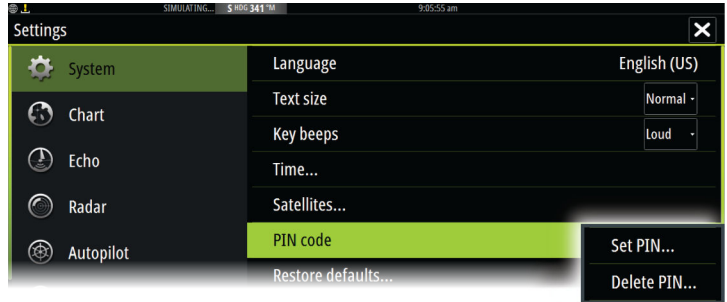

Adding new favorite pages

1. Select the **New** icon in the favorite panel on the **Home** page to open the page editor dialog
2. Drag and drop page icons to set up a new page
- **Note:** 5" unit favorite pages can have a maximum of 2 applications.
3. Change the panel arrangement (only possible for 2 or 3 panels), if required
4. Save the page layout.

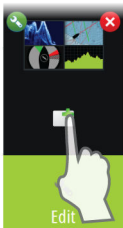

The system displays the new favorite page, and the new page is included in the list of favorite pages on the **Home** page.

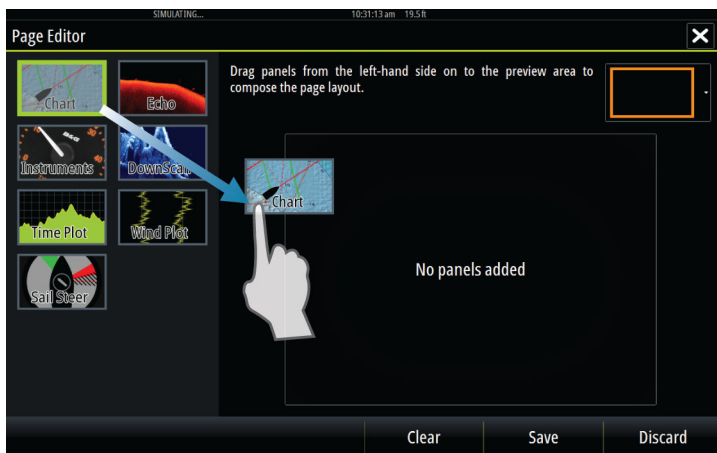

Edit favorite pages

1. Select the edit icon in the Favorite panel:
 - Select the X icon on a favorite icon to remove the page
 - Select the tool icon on a favorite icon to display the page editor dialog
2. Add or remove panels in the page editor dialog
3. Save or discard your changes to leave the favorite edit mode.

Setting the appearance of the Instrument bar

Data sources connected to the system can be viewed in the Instrument bar.

You can configure the Instrument bar to display either one or two bars. If you specify to display two bars you can set it to alternate the bars automatically. You can specify the information displayed in the instrument bars.

You can turn the Instrument bar off from the **System controls** dialog.

→ **Note:** This only turns the Instrument bar off for the current page.

Turning the Instrument bar on/off

1. Activate the **System controls** dialog
2. Deactivate/activate the instrument bar icon to toggle the bar on and off.

Select a predefined activity bar

1. Select the **MENU** button to open the menu
2. Select **Bar 1** or **Bar 2** and then a predefined activity bar.

Predefined gauges are displayed in the instrument bar. You can change a gauge in the activity Instrument bar, refer to Edit the content of the Instrument bar below.

Edit the content of the Instrument bar

1. Activate the Instrument bar by selecting it
2. Select the **MENU** button to open the menu
3. Select **Edit** to change an instrument gauge followed by the gauge you want to change
4. Select the content you want to display from the Choose Data dialog
5. Select **Menu** and then **Finish editing** to save your changes.

4

Charts

The chart function displays your vessel's position relative to land and other chart objects. On the chart panel you can plan and navigate routes, place waypoints, and display AIS targets.

The Chart panel

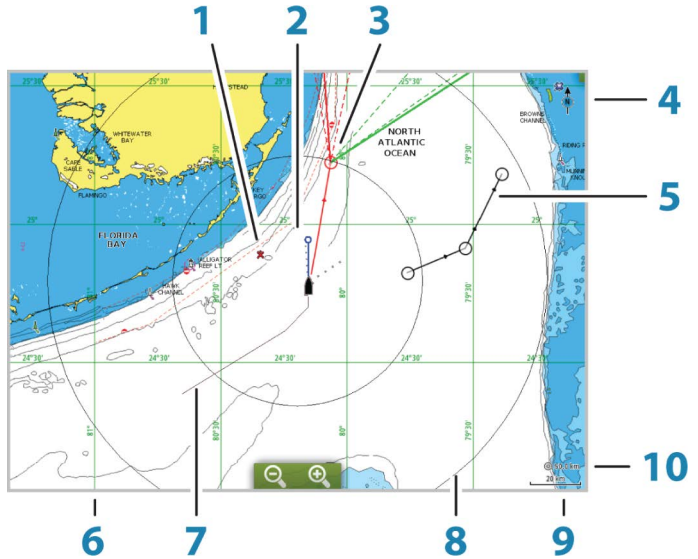

- 1 MOB (Man Over Board) mark
- 2 Vessel with extension line (extension line is optional)
- 3 Waypoint with Laylines*
- 4 North indicator
- 5 Route*
- 6 Grid lines*
- 7 Track*
- 8 Range rings*
- 9 Chart range scale
- 10 Range rings interval (only displayed when Range rings are turned on)

* Optional chart items. You turn the optional chart items on/off individually from the Chart settings dialog.

Chart data

The system is delivered with different embedded cartography depending on region.

All units support Insight charts from Navico including Insight Genesis. The system also supports charts from Navionics and C-MAP as well as content created by a variety of third party mapping providers in the AT5 format. For a full selection of available charts, visit www.gofreeshop.com, www.c-map.com, or www.navionics.com.

- **Note:** In this manual, all possible chart menu options are described. These options vary depending on the chart you are using.
- **Note:** The system does not automatically switch to embedded cartography if the chart card is removed. A low-resolution chart will be displayed until you re-insert the card or manually switch back to the embedded cartography.

Showing dual chart types

If you have different chart types available - embedded or in the card slot - you can show two different chart types simultaneously on a page with two chart panels.

You can select a dual chart panel by pressing and holding the Chart application button on the **Home** page, or by creating a favorite page with two chart panels.

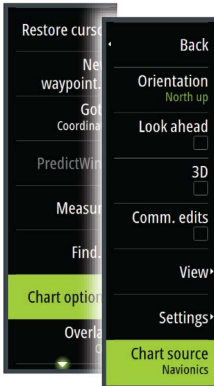

Selecting chart type

You specify the chart type in the Chart panel by selecting one of the available chart types in the chart source menu option.

If you have a multiple Chart panel, the chart type is set individually for each chart panel. Activate one of the chart panels, and then select one of the available chart types in the chart source menu option. Repeat the process for the second chart panel, and select an alternative chart type for this panel.

If you have identical charts available - built in or in the card slot - the system automatically selects the chart with most chart details for your displayed region.



Vessel symbol

When the system has a valid GPS position lock, the vessel symbol indicates vessel position. If no GPS position is available, the vessel symbol includes a question mark.



Chart scale

Chart range scale and range rings interval (when turned on) are shown in the lower right corner of the chart panel.

Panning the chart

You can move the chart in any direction by dragging your finger on the screen.

Select the **Clear cursor** menu option to remove the cursor and cursor window from the panel. This also centers the chart to the vessel position.

Positioning the vessel on the chart panel

Chart orientation

Several options are available for how the chart is rotated in the panel. The chart orientation symbol in the panel's upper right corner indicates the north direction.

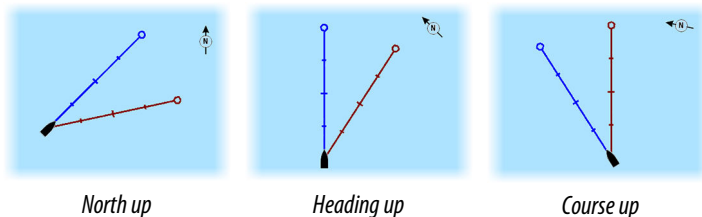

North up

Displays the chart with north upward.

Heading up

Displays the chart with the vessel's heading directed upward. Heading information is received from a compass. If heading is not available, then the COG from the GPS is used.

Course up

Displays the chart with the direction the vessel is ACTUALLY traveling directed upward, which in some cases is not the direction the vessel is headed.

Look ahead

Moves the vessel icon closer to the bottom of the screen so that you can maximize your view ahead.

Displaying information about chart items

When you select a chart item, a waypoint, a route, or a target, basic information for the selected item is displayed. Select the chart item's pop-up to display all available information for that item. You can also activate the detailed information dialog from the menu.

- **Note:** If you are viewing applicable C-MAP charts on your system, you can select marine objects to display information about services and available multimedia (photos) associated with the location or object.
- **Note:** Pop-up information has to be enabled in chart settings to see basic item information.

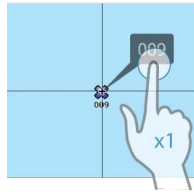

Using the cursor on the chart panel

By default, the cursor is not shown on the chart panel.

When you activate the cursor, the cursor position window is displayed. When the cursor is active, the chart does not pan or rotate to follow the vessel.

Select the **Clear cursor** menu option to remove the cursor and the cursor window from the panel. This also centers the chart to the vessel position.

Select the **Restore cursor** menu option to display the cursor in its previous location. The **Clear cursor** and **Restore cursor** options are useful features for toggling between the vessel's current location and the cursor position.

N 59°01.280'
E 13°37.148'
110.5 mi, 104 °M

GoTo cursor

You can navigate to a selected position on the image by positioning the cursor on the panel, then using the **Goto Cursor** option in the menu.

The cursor assist function

The cursor assist function allows for fine tuning and precision placement of the cursor without covering details with your finger.

Activate the cursor on the panel, then press and hold your finger on the screen to switch the cursor symbol to a selection circle, appearing above your finger.

Without removing your finger from the screen, drag the selection circle to the desired position.

When you remove your finger from the screen the cursor reverts to normal cursor operation.

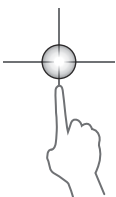

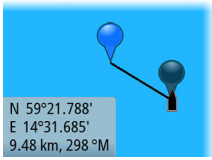

Measuring distance

The cursor can be used to measure the distance between your vessel and a selected position, or between 2 points on the chart panel.

1. Position the cursor on the point from where you want to measure the distance. Start the measure function from the menu
 - The measuring icons appear with a line drawn from the vessel center to the cursor position, and the distance is listed in the cursor information window.
 2. You can reposition the measuring points by dragging either icon as long as the measuring function is active
- **Note:** The bearing is always measured from the grey icon to the blue icon.

You can also start the measuring function without an active cursor. Both measuring icons are then initially located at the vessel position. The grey icon follows the vessel as the vessel moves, while the blue icon remains at the position given when you activated the function.

You terminate the measuring function by selecting the **Finish measuring** menu option.

Saving waypoints

You can save a waypoint at a selected location by positioning the cursor on the panel, and then selecting the new waypoint option in the menu.

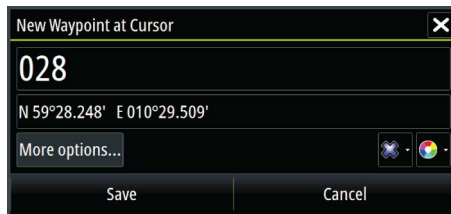

In the Chart and Nav panels, you can save a waypoint at the vessel position, when the cursor is not active, by selecting the new waypoint option in the menu.

Creating routes

You can create routes as follows on the chart panel.

1. Position the cursor on the chart panel
2. Select **New** followed by **New route** in the menu
3. Tap the chart panel to position the first routepoint
4. Continue positioning the remaining routepoints
5. Save the route by selecting the save option in the menu.

→ **Note:** For more information, refer to "*Waypoints, Routes, and Tracks*" on page 56.

Find objects on chart panels

You can search for other vessels or various chart items from a chart panel.

Activate the cursor on the panel to search from the cursor position. If the cursor is not active, the system searches for items from the vessel's position.

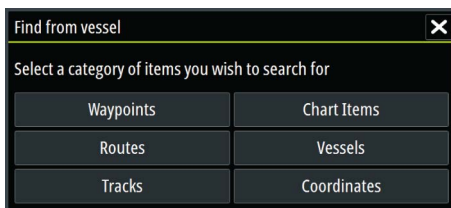

→ **Note:** You must have a SIRIUS data package subscription to search for fueling stations and an AIS receiver connected to search for vessels. SIRIUS is not available on 5" and 7" units.

3D charts

The 3D option provides a three dimensional graphical view of land and sea contours.

→ **Note:** All chart types work in 3D mode, but without 3D cartography for the appropriate area the chart appears flat.

When the 3D chart option is selected, the Pan and the Rotate icons appear on the chart panel.



Panning the 3D chart

You can move the chart in any direction by selecting the Pan icon and then panning in the desired direction.

Select the **Return to vessel** menu option to stop panning, and to center the chart to vessel position.



Controlling the view angle

You can control the view angle by selecting the Rotate icon and then panning the chart panel.

- To change the direction you are viewing, pan horizontally
- To change the tilt angle of the view, pan vertically

→ **Note:** When centered on the vessel position, only the tilt angle can be adjusted. The view direction is controlled by the chart orientation setting. See "*Positioning the vessel on the chart panel*" on page 31.

Zooming a 3D chart

You zoom in and out on a 3D chart by using the zoom (+ or -) buttons, or the touch method of pinching and spreading your fingers.

Color tracks based on data

A track can be colored based on what source data and the high/low limits you set:

- Select the color tracks menu option and then the source option to specify the source (data type) to be colored. To turn off coloring, select source **None**.

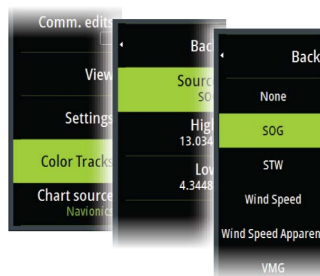

- Select the high and low options to set high and low values (after you specify the source).

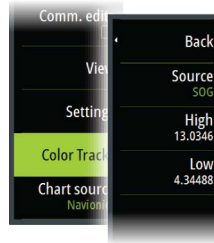

A colored track represents only one data source at a time. If you switch from one source to another, then the colors represent the newly selected source.

The colors can be shades of green, yellow, and red. Green is for the high limit you set. Yellow is the value that is the average of the high and low. Red is for the low limit. If the value is between the high and the middle values, it appears as a greenish-yellow color. If the value is between the middle and the low, it appears as an orange color.

→ **Note:** By default tracks are colored according to the color setting in the Edit Track dialog. Coloring tracks based on source data overrides the coloring specified in the Edit Track dialog.

If two or more charts are displayed in a split panel, changing the color source or high/low values on one chart does not change the other charts.

Displaying source data in the cursor window

Selecting a point in a trail displays the cursor position window. If recorded source data exists for the point selected, the value is shown in the window in addition to the other cursor information.

The system records data according to your settings in the edit Trail dialog. Source data points are recorded when there is a change in the course or heading.



Cursor position window showing no SOG value



Cursor position window showing SOG value

Chart overlay

Structure, SonarChart Live (Navionics charts only) and weather data can be displayed as overlay on your chart panel.

→ **Note:** Radar can also be displayed as overlay on chart panels on units with radar. Radar functions are described in the chapter "Radar" in this manual.

When an overlay is selected, the chart menu expands to include basic menu functions for the selected overlay.

Information about the overlay data are described in more detail in separate sections in this manual.

PredictWind weather and routing

For information about PredictWind weather and PredictWind routing, refer to "*PredictWind*" on page 86.

Insight and C-MAP charts

All possible menu options for Insight and C-MAP charts are described below. The features and menu options available can vary depending on the charts you use. This section shows menus from an Insight chart.

→ **Note:** A menu option is greyed out if it is not available on the chart displayed. For example, raster charts are not available with Insight, so the Raster charts menu option is greyed out when Insight charts are displayed.

Insight and C-MAP tides and currents

The system can display Insight and C-MAP tides and currents. With this information it is possible to predict the time, level, direction and

strength of currents and tides. This is an important tool when considering planning and navigation of a trip.

In large zoom ranges the tides and currents are displayed as a square icon including the letter **T** (Tides) or **C** (Current). When you select one of the icons, tidal or current information for that location is displayed.

Dynamic current data can be viewed by zooming inside a 1-nautical mile zoom range. At that range, the Current icon changes to an animated dynamic icon that shows the speed and direction of the current. Dynamic icons are colored in black (greater than 6 knots), red (greater than 2 knots and less than or equal to 6 knots), yellow (greater than 1 knot and less than or equal to 2 knots) or green (equal to or less than 1 knot), depending on the current in that location.

If there is no current (0 knots) this will be shown as a white, square icon.

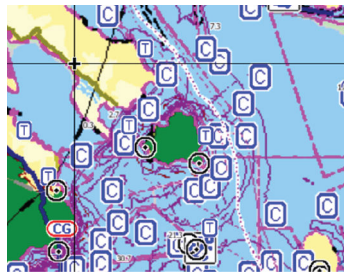

Static Current and Tide icons

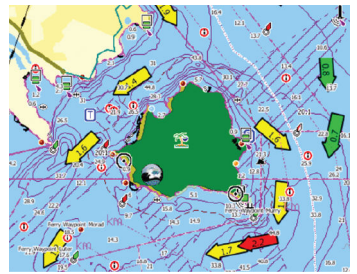

Dynamic Current icons

Insight and C-MAP specific chart options

Orientation, Look ahead, 3D, and change Chart source (previously described in this section) are common for all chart types.

Presentation

The charts can be displayed in different imagery styles.

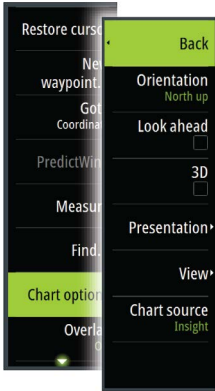

Shaded relief

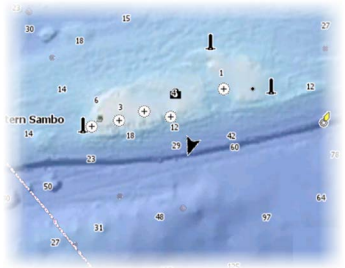

No contours

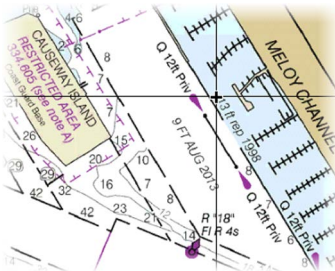

Raster imagery

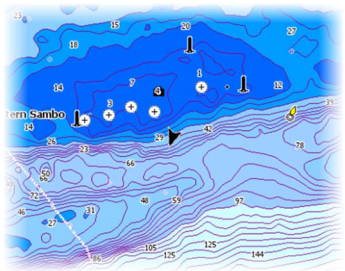

High resolution bathymetry

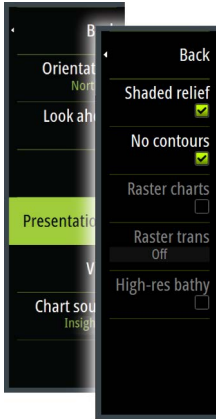

Shaded relief

Shades seabed terrain.

No contours

Removes contour lines from the chart.

Raster charts

Changes the view to that of a traditional paper chart.

Raster transparency

Controls the transparency of raster imagery.

High resolution bathymetry

Enables and disables higher concentration of contour lines.

Genesis Layer

The Genesis Layer displays high-resolution contours contributed by Genesis users that have passed a quality check.

This option toggles the Genesis layer on/off on the chart image.

When the Genesis layer is on, the High-res bathy is disabled.

Available only if the C-MAP chart contains Genesis Layer data.

Insight and C-MAP view options

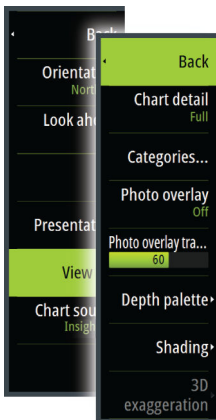

Chart detail

- **Full**
All available information for the chart in use.
- **Medium**
Minimum information sufficient for navigation.
- **Low**
Basic level of information that cannot be removed, and includes information that is required in all geographic areas. It is not intended to be sufficient for safe navigation.

Insight and C-MAP chart categories

Insight and C-MAP charts include several categories and sub-categories that you can turn on/off individually depending on which information you want to see.

Photo overlay

Photo overlay enables you to view satellite photo images of an area as an overlay on the chart. The availability of such photos is limited to certain regions, and cartography versions.

You can view photo overlays in either 2D or 3D modes.



Photo transparency

The Photo transparency sets the opaqueness of the photo overlay. With minimum transparency settings the chart details are almost hidden by the photo.

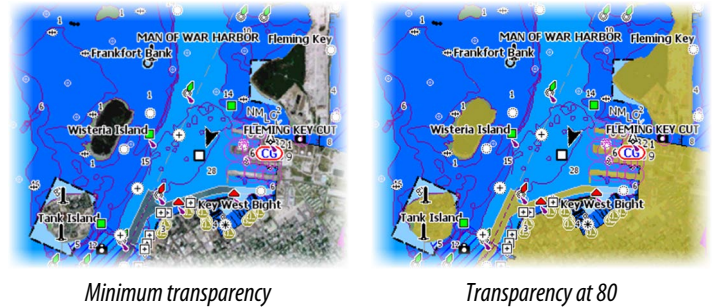

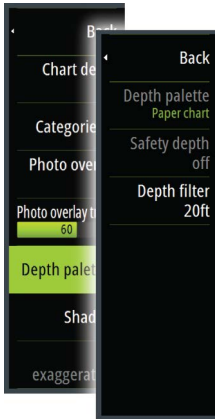

Depth palette

Controls the Depth palette used on the map.

Paper chart

Changes the appearance of the map to a paper chart style.

Safety depth

Insight and C-MAP charts use different shades of blue to distinguish between shallow (lighter shades) and deep (darker shades) water. After enabling Safety depth, specify the desired safety depth limit. The Safety depth sets the limit at which depths will be drawn without blue shading.

Depth filter

Filters out depth values shallower than the selected depth filter limit.

Shading

Shades different areas of the seabed, depending on the selected Shading category.

→ **Note:** Composition and Vegetation shading are not applicable to C-MAP charts.

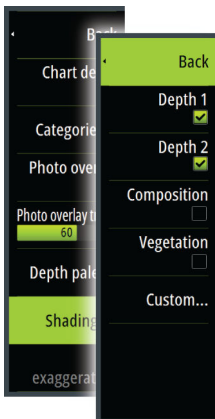

Depth 1 and Depth 2

Depth presets that shade different depths in different colors.

Custom

You can adjust the depth threshold, color and opacity (transparency) of color shading for Depth 1 and Depth 2.

Depth (m)	Color	Opacity (%)
0		100
10		40
24		100
37		100
49		100
Add Point...		

3D exaggeration

Graphical settings that are available in 3D mode only. Exaggeration is a multiplier applied to the drawn height of hills on land, and troughs in water to make them look taller or deeper.

→ **Note:** This option is grayed out if the data is not available in the map card inserted.

Navionics charts

Some Navionics features require the most current data from Navionics. For those features, a message is displayed stating that the feature is unavailable if you do not have the appropriate Navionics charts or chart card inserted. For more information on what is required for these features, refer to www.navionics.com.

You can also get a message if you try to use a restricted feature when the Navionics chart card is not activated. To activate the card, contact Navionics.

Navionics specific chart options

Orientation, Look ahead, 3D and change Chart source (previously described in this section) are common for all chart types.

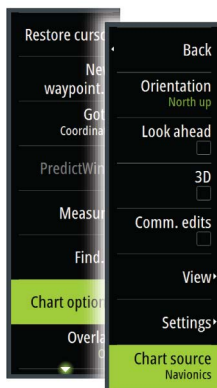

Community edits

Toggles on the chart layer including Navionics edits. These are user information or edits uploaded to Navionics Community by users, and made available in Navionics charts.

For more information, refer to Navionics information included with your chart, or to Navionics website: www.navionics.com.

SonarChart Live

SonarChart Live is a real-time feature where the device creates an overlay of depth contours based on your own live sonar soundings.

In the Navionics chart menu, select **Overlay** and then **SonarChart Live** to display it as an overlay on the chart.

When you select SonarChart Live overlay the menu expands to display SonarChart Live Options. Use the options to set the transparency and minimum depth.

Transparency

The SonarChart Live overlay is drawn on top of other chart data. The chart data is completely covered at minimum transparency. Adjust the transparency to allow the chart details to be seen.

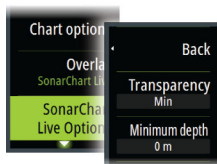

Minimum depth

Adjusts what SonarChart Live rendering treats as the safety depth. This affects the coloring of the SonarChart Live area. As the vessel approaches the safety depth, the SonarChart Live area will gradually change from a simple grey/white to red.

SCL History

→ **Note:** If no active Navionics chart subscription is found, the SonarChart Live menu option changes to SCL History.

Select to display previously recorded data on the chart overlay.

Navionics view options



Chart shading

Shading adds terrain information to the chart.

Navionics dynamic tide and current icons

Shows tides and currents with a gauge and an arrow instead of the diamond icons used for static tides and current information.

The tide and current data available in Navionics charts are related to a specific date and time. The system animates the arrows and/or gauges to show the tides and currents evolution over time.

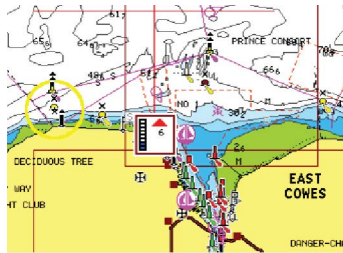

Dynamic tide information

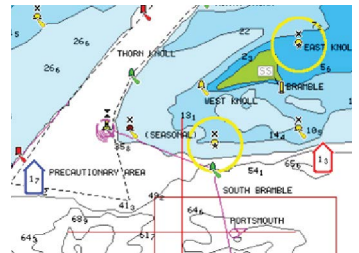

Dynamic current information

The following icons and symbology are used:



Current speed

The arrow length depends on the rate, and the symbol is rotated according to flow direction. Flow rate is shown inside the arrow symbol. The red symbol is used when current speed is increasing, and the blue symbol is used when current speed is decreasing.



Tide height

The gauge has 8 labels and is set according to absolute max/min value of the evaluated day. The red arrow is used when tide is rising, and the blue arrow is used when tide is falling.

→ **Note:** All numeric values are shown in the relevant system units (unit of measurement) set by user.

Easy View

Magnifying feature that increases the size of chart items and text.

→ **Note:** There is no indication on the chart showing that this feature is active.

Photo overlay

Photo overlay enables you to view satellite photo images of an area as an overlay on the chart. The availability of such photos is limited to certain regions, and cartography versions.

You can view photo overlays in either 2D or 3D modes.



Photo transparency

The Photo transparency sets the opaqueness of the photo overlay. With minimum transparency settings the chart details are almost hidden by the photo.

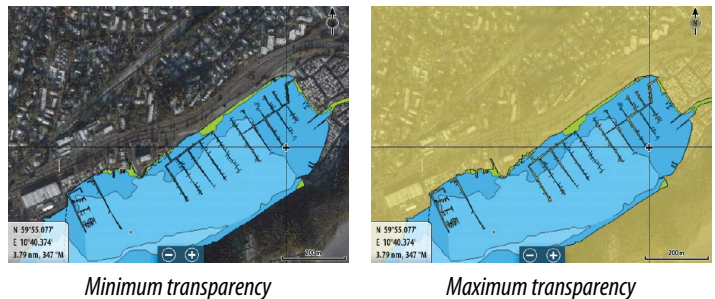

SonarChart

The system supports the Navionics SonarChart feature.

SonarChart displays a bathymetry map showing high resolution contour detail and standard navigational data. For more information, refer to www.navionics.com.

SC Density

Controls the density of the SonarChart and SonarChart Live contours.

Fishing range

Select a range of depths between which Navionics fills with a different color.

This allows you to highlight a specific range of depths for fishing purposes. The range is only as accurate as the underlying chart data, meaning that if the chart only contains 5 meter intervals for contour lines, the shading is rounded to the nearest available contour line.

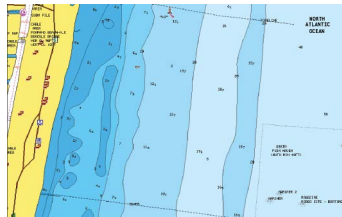

No Depth highlight range

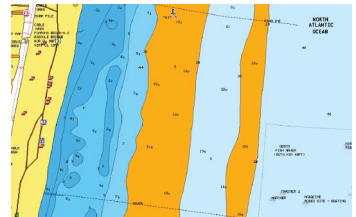

Depth highlight range: 6 m - 12 m

Shallow water highlight

Highlights areas of shallow water.

This allows you to highlight areas of water between 0 and the selected depth (up to 10 meters/30 feet).

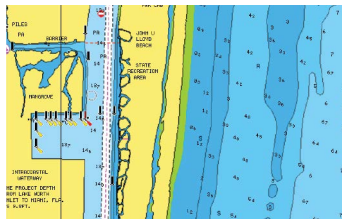

No shallow water highlighted

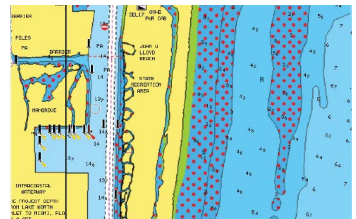

Shallow water highlight: 0 m - 3 m

Navionics chart settings

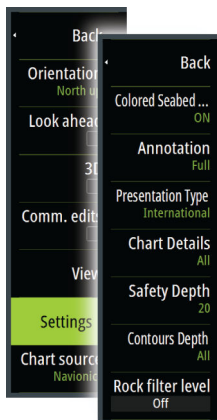

Colored seabed areas

Used for displaying different depth areas in different shades of blue.

Annotation

Determines what area information, such as names of locations and notes of areas, is available to display.

Presentation type

Provides marine charting information such as symbols, colors of the navigation chart and wording for either International or U.S. presentation types.

Chart details

Provides you with different levels of geographical layer information.

Safety depth

The Navionics charts use different shades of blue to distinguish between shallow and deep water.

Safety depth, based on a selected limit, is drawn without blue shading.

→ **Note:** The built in Navionics database features data down to 20 m, after which it is all white.

Contours depth

Determines which contours you see on the chart down to the selected safety depth value.

Rock filter level

Hides rock identification on the chart beneath a given depth.

This helps you to declutter charts in areas where there are many rocks located at depths well below your vessel's draught.

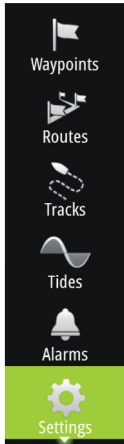
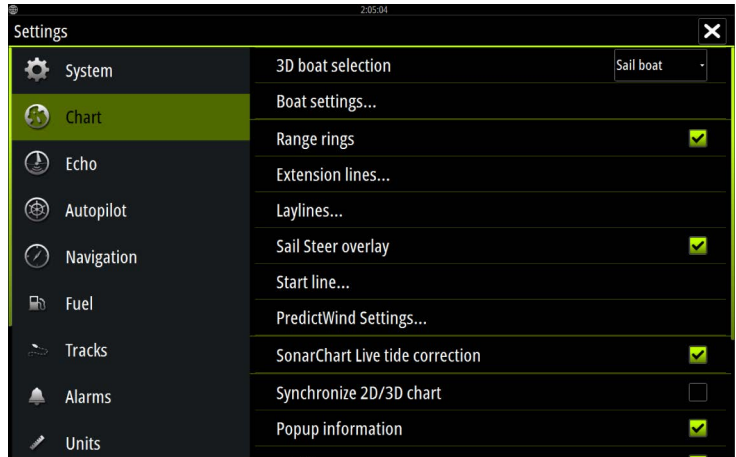

Chart settings

Settings and display options made in the Chart settings page are common for all chart panels.



3D boat selection

Determines which icon to use on 3D charts.

Boat settings

The boat settings are used when calculating an automatic route. The boat's draught, width and height must be input to use Navionics Dock-to-dock autorouting and easy routing features.

→ **Note:** Dock-to-dock Autorouting is not available in units used in U.S. territorial waters.

Range Rings

The range rings can be used to present the distance from your vessel to other chart objects.

The range scale is set automatically by the system to suit the chart scale.

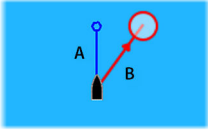

Extension lines

A: Heading

B: Course Over Ground (COG)

The lengths of the extension lines are either set as a fixed distance, or to indicate the distance the vessel moves in the selected time period. If no options are turned on for the vessel then no extension lines are shown for your vessel.

Your vessel heading is based on information from the active heading sensor and the COG is based on information from the active GPS sensor.

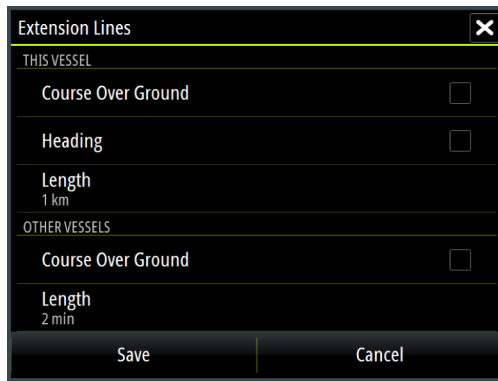

ForwardScan

If you have ForwardScan and this option is selected, the ForwardScan heading extension is shown on the chart. Refer to "*Heading extension*" on page 158.

Laylines

Configures the options for laylines on the chart and on the SailSteer panels.

The image shows laylines from mark/waypoint with limits.

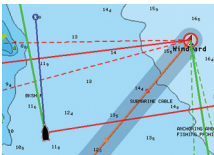

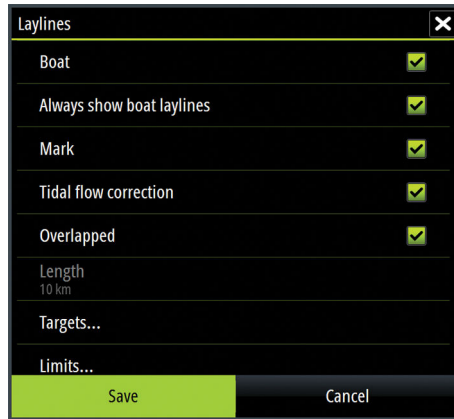

Boat

Displays laylines from boat, indicating the target course.

Always show boat laylines

Displays boat laylines.

Mark

Displays laylines from mark/waypoint, indicating the target course to sail to reach the mark/waypoint.

Tidal flow correction

Calculates the tidal effect of the boat based on COG, and applies this information to the laylines.

Overlapped

Extends the laylines beyond the tack/gybe intersection.

Length

Sets the length of the laylines.

→ **Note:** This option is only available if Boat is not selected.

Targets

Defines the target for a given TWS (True Wind Speed). The targets can be read from an H5000 CPU Polar table, live measurements,

manually entered upwind and downwind angles, or from the targets table.

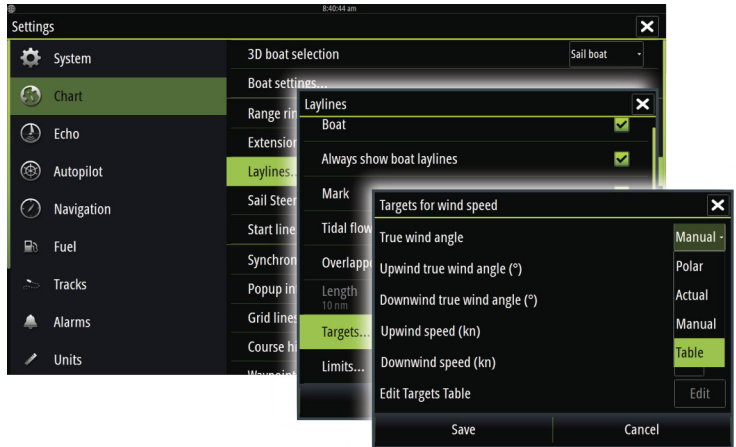

- Laylines targets table
 Edit the targets table to specify Upwind True Wind Angle (TWA), Upwind Boat Speed (BS), Downwind TWA, and Downwind BS values for different true wind speeds. Accurate table information gives the system a better basis for creating target laylines.

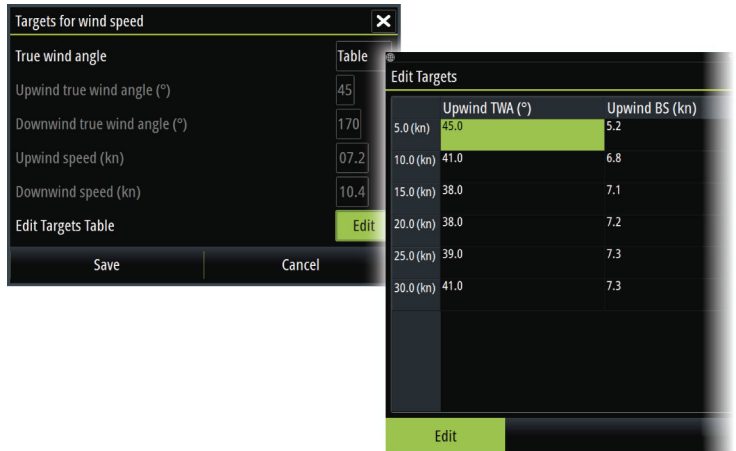

Limits

Sets the minimum and maximum tack/gybe time period either side of the layline. This can be set to 5, 10, 15 and 30 minute increments. When turned on, the limits are indicated with a dotted line either side of the layline.

SailSteer overlay

Turns on/off viewing of SailSteer image overlay on the chart. Refer to "*SailSteer overlay*" on page 73.

Start line

Select this option to specify if the start line, its laylines, and neutral lines appear on the chart, and if/when to hide start line after start.

PredictWind Settings

Used to enter your PredictWind credentials and specify how to download weather files. The credentials are also used when downloading routes from the PredictWind web site.

For more information about PredictWind weather, refer to "*PredictWind weather*" on page 86. For more information about PredictWind routing, refer to "*PredictWind weather routing and departure planner*" on page 92.

SonarChart Live tide correction

When selected, the tide correction feature uses information from nearby tide stations (if available) to adjust the depth values used by SonarChart Live as the sonar is recorded.

Synchronize 2D/3D chart

Links the position shown on one chart with the position shown on the other chart when a 2D and a 3D chart are shown side by side.

Pop-up information

Selects whether basic information for chart items is displayed when you select the item.

Grid lines

Turns on/off viewing of longitude and latitude grid lines on the chart.

Course highway

Adds a graphic presentation of cross track error (XTE) limits to the route. For setting the XTE limit, see "*XTE limit*" on page 69.

Waypoints, Routes, Tracks

Turns on/off displaying of these items on chart panels. Also opens the Waypoints, Routes and Tracks dialogs you can use to manage them.

5

Waypoints, Routes, and Tracks

Waypoints

A waypoint is a user generated mark positioned on a chart, or on the Echosounder image. Each waypoint has an exact position with latitude and longitude coordinates. A waypoint positioned on the Echosounder image has a depth value, in addition to position information. A waypoint is used to mark a position you later may want to return to. Two or more waypoints can also be combined to create a route.

Saving waypoints

You can save a waypoint at a selected location by positioning the cursor on the panel, and then selecting the new waypoint option in the menu.

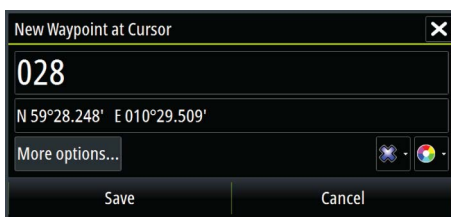

In the Chart and Nav panels, you can save a waypoint at the vessel position, when the cursor is not active, by selecting the new waypoint option in the menu.



Moving a waypoint

1. Select the waypoint you want to move. The waypoint icon expands to indicate that it is active.
2. Activate the menu and select the waypoint in the menu
3. Select the move option
4. Select the new waypoint position
5. Select Finish in the menu.

The waypoint is now automatically saved at the new position.

Edit a waypoint

You can edit all information about a waypoint from the **Edit Waypoint** dialog.

This dialog is activated by selecting the waypoint's pop-up, or from the menu when the waypoint is activated.

The dialog can also be accessed from the Waypoints tool on the **Home** page.

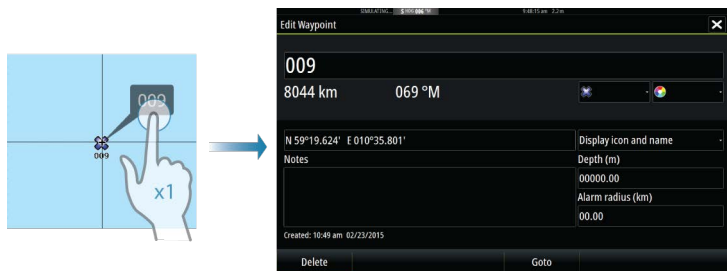

Delete a waypoint

You can delete a waypoint from the **Edit Waypoint** dialog or by selecting the **Delete** menu option when the waypoint is activated.

You can also delete waypoints from the Waypoints tool on the **Home** page.

You can delete MOB waypoints the same way.

Waypoint alarm settings

You can set an alarm radius for each individual waypoint you create. The alarm is set in the **Edit Waypoint** dialog.

→ **Note:** The waypoint radius alarm must be toggled ON in the alarm dialog to activate an alarm when your vessel comes within the defined radius. For more information, refer to "*Alarms dialog*" on page 199.

Routes

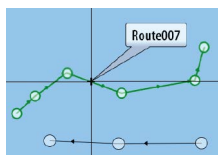

A route consists of a series of routepoints entered in the order that you want to navigate them.

When you select a route on the chart panel it turns green, and the route name is displayed.

The system includes support for Navionics Autorouting and C-MAP Easy Routing. This feature automatically suggests routepoints between the first and last routepoint of a route, or between selected routepoints in a complex route. You can use the feature when you create a new route, or you can use it to edit already saved routes.

Creating a new route on the chart panel

1. Activate the cursor on the chart panel
2. Select the new route option from the menu
3. Position the first waypoint on the chart panel
4. Continue positioning new routepoints on the chart panel until the route is completed
5. Save the route by selecting the save option in the menu.

Edit a route from the chart panel

1. Select the route to make it active
 2. Select the route edit option in the menu
 3. Position the new routepoint on the chart panel:
 - If you set the new routepoint on a leg, a new point is added between existing routepoints
 - If you set the new routepoint outside the route, the new routepoint is added after the last point in the route
 4. Drag a routepoint to move it to a new position
 5. Save the route by selecting the save option in the menu.
- **Note:** The menu changes depending on the selected edit option. All edits are confirmed or cancelled from the menu.

Delete a route

You can delete a route by selecting the **Delete** menu option when the route is activated. You can also delete routes from the Routes tool on the **Home** page.

Create a race route

A race route has waypoints with rounding indicators and a waypoint indicating the finish line. When the race route is being followed, only the next rounding indicator is shown on the chart. The part of the route that has not been navigated is highlighted orange. When a part of the route has been navigated it turns black..

To create a race route, do the following:

1. Turn on the race route feature by selecting the Race option in the Advanced Settings dialog Features directory.



When the race route feature is selected, the Race mode option is available on the Edit Route dialog.

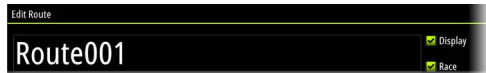

2. Create a new route. Refer to "*Routes*" on page 58. Alternatively, you can select an existing route and change it to a Race route by performing step 3.
3. Open the route in the Edit Route dialog, select the Race mode option, add rounding indicators and specify a waypoint as the finish line. Refer to "*Setting rounding indicators*" on page 59. If you do not set the indicators, the system will add them based on what it thinks is correct.

Setting rounding indicators

To set rounding indicators and indicate a waypoint as the finish line, edit the route using the Edit Route dialog. When the race option is selected, the rounding column is available.

Once the rounding indicator and finish waypoint indicator are set they are shown on the race route on the chart.

The current rounding setting is shown in the column for each waypoint in the race route. Change the indicator for a waypoint by selecting one of the options in the drop-down list:

- Auto, auto determination of rounding
- Port, round to port
- Stbd, round to starboard
- Finish, waypoint is the finish line

Select **Save** to save your settings.

Dock-to-dock Autorouting and Easy Routing

The Dock-to-dock Autorouting and Easy Routing suggest new routepoint positions based on information in the map and on your boat's size. Before you can start using this feature the boat draught, width and height must be entered into the system. The boat settings dialog is automatically displayed if the information is missing when you start the feature.

- **Note:** Units designed for sale in the U.S. region do not have Autorouting capabilities. Autorouting features are disabled on all non-U.S. units when they are used in U.S. territorial waters.
 - **Note:** It is not possible to start the Dock-to-dock Autorouting or Easy Routing if one of the selected routepoints is located in an unsafe area. A warning dialog is displayed, and you have to move the relevant routepoint(s) to a safe area to proceed.
 - **Note:** If no compatible cartography is available, the Dock-to-dock Autorouting or Easy Routing menu option is not available. Compatible cartography includes C-MAP MAX-N+, Navionics+ and Navionics Platinum. For a full selection of available charts, visit www.gofreemarine.com, www.c-map.com or www.navionics.com.
1. Position at least two routepoints on a new route, or open an existing route for editing.
 2. Select **Dock-to-dock Autorouting**, followed by:
 - **Entire Route** if you want the system to add new routepoints between the first and the last routepoint of the open route.
 - **Selection** if you want to manually select the routepoints that define the limits for the autorouting, then select the relevant routepoints. Selected routepoints are colored red. Only two routepoints can be selected, and the system discards any routepoints between your selected start and end points.
 3. Select **Accept** to start the automatic routing.
 - When the automatic routing is completed the route appears in preview mode, and the legs are color coded to indicate safe or unsafe areas. Navionics uses red (unsafe) and green (safe), while C-MAP uses red (unsafe), yellow (dangerous) and green (safe).
 4. Move any routepoints if required when the route is in preview mode.

5. Select **Keep** to accept the routepoints positions.
6. Eventually repeat step 2 (**Selection**) and step 3 if you want the system to automatically position routepoints for other parts of the route.
7. Select **Save** to complete the automatic routing and save the route.

Dock-to-dock Autorouting and Easy Routing examples

- **Entire route** option used when first and last route points are selected.



First and last routepoint



Result after automatic routing

- **Selection** option used for autorouting part of a route.



Two routepoints selected



Result after automatic routing

PredictWind weather and routing

For information about PredictWind weather and PredictWind routing, refer to "PredictWind" on page 86.

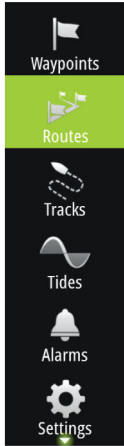

Creating routes using existing waypoints

You can create a new route by combining existing waypoints from the **Routes** dialog. The dialog is activated by using the **Routes** tool on the **Home** page.

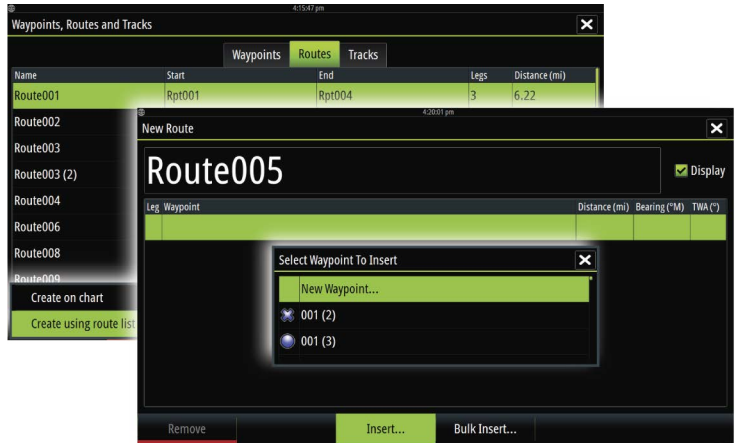

Routes - bulk insert waypoints

Use the bulk insert option to enter a list of waypoints separated by commas (for example 21,22,23,24) to create a new route or add multiple waypoints to an existing route.

1. Make a note of the waypoints you want to bulk enter. You do not have to enter the full waypoint ID, just enough of it to distinguish it.
2. Select Routes on the Tool panel
3. Select the New button and then select the Create using route list option. Alternatively, scroll down the list of existing routes and select New Route.
4. Select the first row in the New route dialog, so that it is highlighted
5. Select the Bulk Insert button

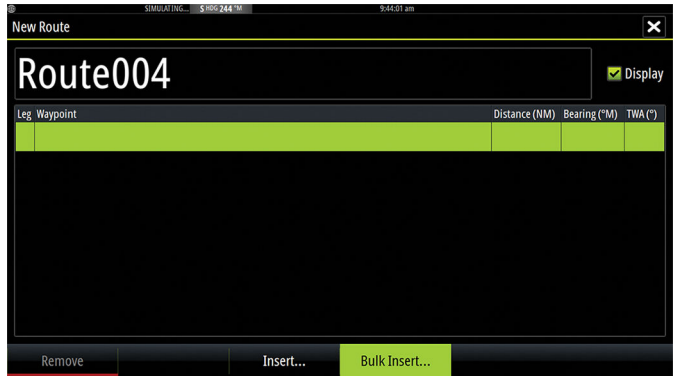

6. Enter a list of waypoints separated by commas (for example; 21,22,23,24). You can include rounding indicators in the bulk entry by adding either .P (for Port) or .S (for Starboard) to the waypoints (for example; 21.S, 22.P, 23.S, 24.P). The system changes the route to a race route if rounding indicators are included in the bulk entry.
7. Select Enter. If the system finds more than one waypoint that has similar IDs, it will choose one and advise you which one it has chosen. If the system does not find a waypoint with a similar ID to what you entered, then a dialog opens and informs you of the items it did not find.
8. (Optional) Give the route a name by selecting the system given name and use the virtual keyboard to enter the name.
9. Select save.

Converting Tracks to Routes

You can convert a track to a route from the Edit Track dialog. The dialog is activated by activating the track, then selecting the track's pop-up, or by selecting the track from the menu.

The Edit Track dialog can also be accessed by selecting the **Tracks** tool on the **Home** page.

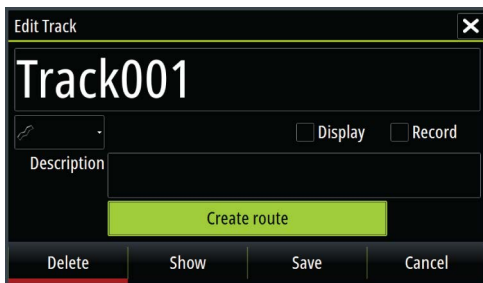

The Edit Route dialog

You can add and remove routepoints, and change route properties using the **Edit Route** dialog. This dialog is activated by selecting an active route's pop-up or from the menu by selecting the route then the details option.

The dialog can also be accessed by using the **Routes** tool on the **Home** page.

Select **Display** to show the route on the chart.

Select **Race** to convert the route to a race route and edit the rounding indicators on route waypoints. Refer to "*Setting rounding indicators*" on page 59. If it is a race route, the system will add the rounding indicators to what it thinks is correct based on the angles.

When adding routepoints, you can insert bulk waypoints. You can also use the bulk insert option to insert route race waypoints with rounding indicators. Refer to "*Routes - bulk insert waypoints*" on page 62.



Tracks

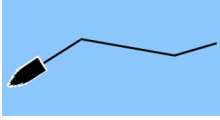

Tracks are a graphical presentation of the historical path of the vessel, allowing you to retrace where you have travelled. Tracks can be converted to routes from the **Edit** dialog.

From the factory, the system is set to automatically track and draw the vessel's movement on the chart panel. The system continues to record the Tracks until the length reaches the maximum points, and then automatically begins overwriting the oldest points.

The automatic tracking function can be turned off from the Tracks dialog.

Creating new Tracks

You can start a new track from the **Tracks** dialog, activated by using the **Tracks** tool on the **Home** page.

Tracks settings

Tracks are made up of a series of points connected by line segments whose length depends on the frequency of the recording.

You can select to position track points based on time settings, distance, or by letting the system position a waypoint automatically when a course change is registered.

→ **Note:** The Tracks option must also be turned ON in the chart settings to be visible.

The track can be colored two ways:

- Select the track in the Tracks dialog and set the color for the entire track in the Edit Track dialog.
- Select to let the system color the track based on source data and high/low settings. Refer to "*Color tracks based on data*" on page 36.

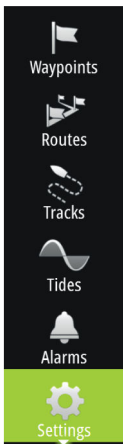

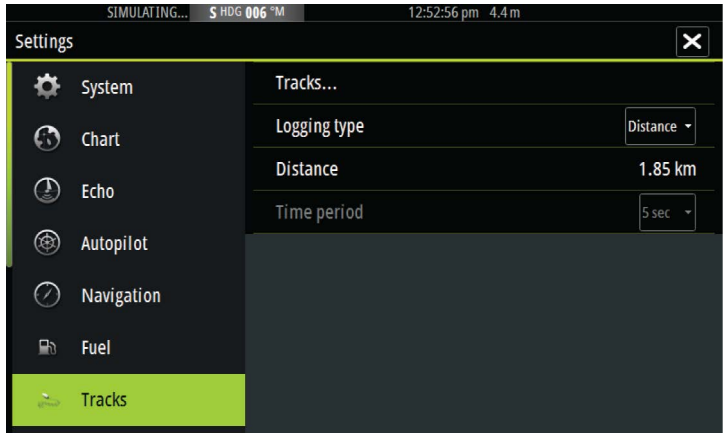

Waypoints, Routes, and Tracks dialogs

The Waypoints, Routes, and Tracks dialogs give access to advanced edit functions and settings for these items.

The dialogs are accessed from the **Tools panel** on the **Home** page.

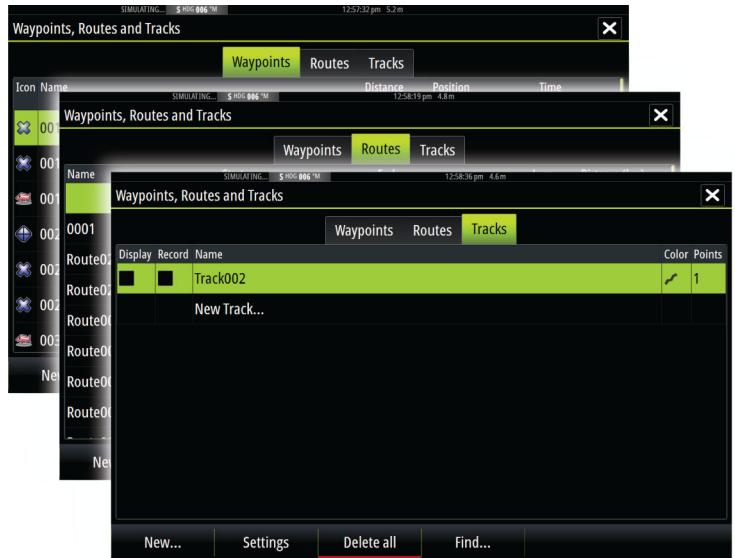

6

Navigating

The navigation function included in the system allows you to navigate to the cursor position, to a waypoint, or along a predefined route.

If autopilot functionality is included in your system, the autopilot can be set to automatically navigate the vessel.

For information about positioning waypoints and creating routes, refer to "*Waypoints, Routes, and Tracks*" on page 56.

Navigate to cursor position

You can start navigating to a cursor position on any chart, or Echosounder panel.

Position the cursor at the selected destination on the panel, and then select the **Goto Cursor** option in the menu.

→ **Note:** The **Goto Cursor** menu option is not available if you are already navigating.

Navigate a route

You can start navigating a route from the chart panel or from the **Route** dialog.

When route navigation is started, the menu expands and shows options for canceling the navigation, for skipping a waypoint, and for restarting the route from current vessel position.

Starting a route from the chart panel

Activate a route on the panel, and then select the route navigation option from the menu.

You can select a routepoint to start navigating from a selected position.

Start navigating a route from the Route dialog

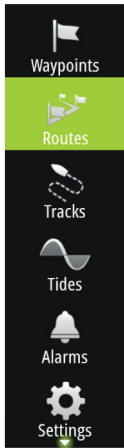

You can start navigating from the **Route** dialog, activated by:

- Selecting the **Route** tool from the **Home** page
- Selecting the route details from the menu

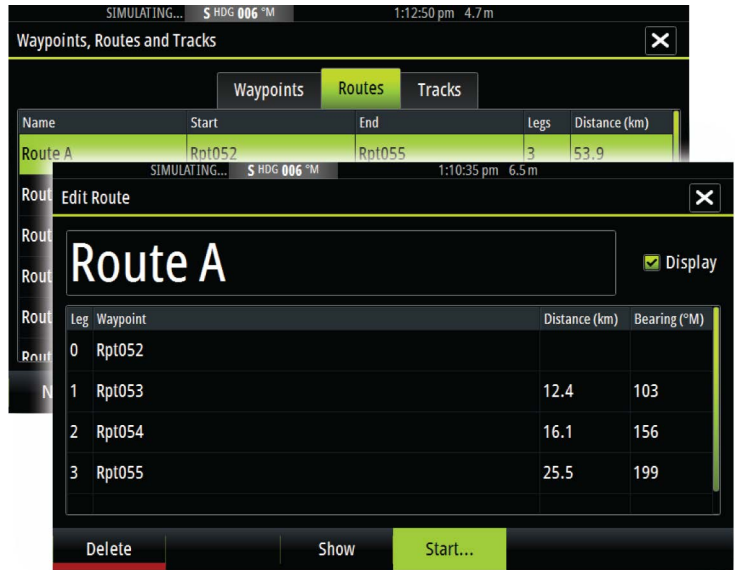

Cancel navigation

When you are navigating, the menu includes an option for cancelling the navigation.

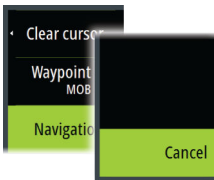

Navigating with the autopilot

When you start navigation on a system with autopilot functionality, you are prompted to set the autopilot to navigation mode.

If you choose not to engage the autopilot or if your boat is set to SAIL, the autopilot can be set to navigation mode from the Autopilot Controller later on. For more information about autopilot functionality, refer to *"Autopilot"* on page 98.

Navigation settings

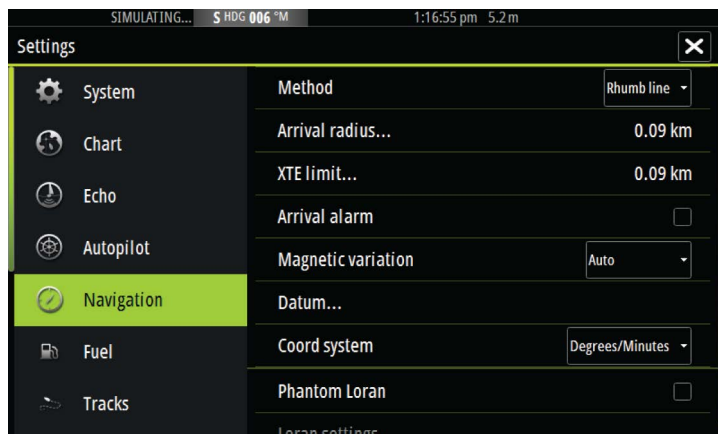
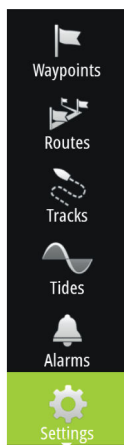

Navigation method

Different methods are available for calculating the distance and bearing between any two points on a chart.

The Great circle route is the shortest path between two points. However, if you are to travel along such a route, it would be difficult to steer manually as the heading would constantly be changing (except in the case of due north, south, or along the equator).

Rhumb lines are tracks of constant bearing. It is possible to travel between two locations using Rhumb line computation, but the distance would usually be greater than if Great circle is used.

Arrival radius

Sets an invisible circle around the destination waypoint.

The vessel is considered arrived at the waypoint when it is within this radius.

XTE limit

This setting defines how far the vessel can deviate from the selected route, if the vessel goes beyond this limit, an alarm is activated.

Arrival alarm

When the arrival alarm is enabled, an alarm is activated when the vessel reaches the waypoint or when it is within the specified arrival radius.

Magnetic variation

Magnetic variation is the difference between true bearings and magnetic bearings, caused by different locations of the Geographic and the Magnetic north poles. Any local anomalies such as iron deposits might also affect the magnetic bearings.

When set to Auto, the system automatically converts magnetic north to true north. Select manual mode if you need to enter your own local magnetic variation.

Datum

Most paper charts are made in the WGS84 format, which also is used by the Vulcan Series.

If your paper charts are in a different format, you can change the datum settings accordingly to match your paper charts.

Coordinate system

Several coordinate systems can be used to control the format for latitude and longitude coordinates displayed on the chart panel.

Phantom Loran

Enables use of Phantom Loran positioning system.

Loran settings

Defines Loran chains (GRI) and preferred station for waypoint entry, cursor position and position panel.

The graphic example shows a cursor position window with Loran position information.

For more information refer to your Loran system documentation.

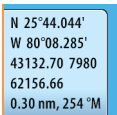

N 25°44.044'
W 80°08.285'
43132.70 7980
62156.66
0.30 nm, 254 °M

7

SailSteer panel

The SailSteer panel provides a composite view of key sailing data. All data is displayed relative to the yacht's bow, providing a clear and easy to understand image of important sailing data.

The SailSteer panel can be shown as a full screen panel, or in a multi-panel page.

The number of data fields included in the panel is dependent on available panel size.

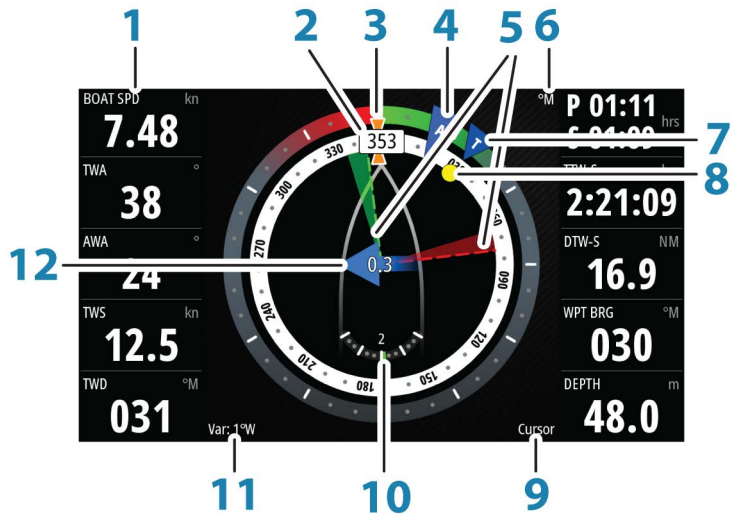

- 1 User configurable data fields
- 2 Vessel heading
- 3 COG (Course Over Ground)
- 4 Apparent wind*
- 5 Port and starboard laylines.
- 6 Magnetic or True reference
- 7 TWA (True Wind Angle) - Green if on TWA upwind or downwind. Blue if off target by 10° or more, or on a free leg. The indicator will fade from blue to green the closer you get to the exact angle.*

- 8 Bearing to current waypoint
- 9 Active (next) waypoint ID, routepoint ID, or cursor
- 10 Rudder angle
 - **Note:** Only visible if a valid rudder source is available on the system.
- 11 Magnetic variation
- 12 Tide rate and relative direction*

* Optional images. You can turn the optional images on/off from the menu.

Selecting data fields for the SailSteer panel

Data sources connected to the system can be viewed on the SailSteer panel.

1. Select the SailSteer panel to make it active.
2. Select the **MENU** button and select the edit option.
 - Edit mode is indicated in top of the panel.
3. Select the instrument field you want to change.
 - The selected field has a highlighted frame.
4. Select the **MENU** button again to select info.
5. Repeat the steps to change other instrument fields.
6. Save your settings by selecting the save option in the menu.

Sail Time calculations

The system calculates the time and distance to a waypoint taking into consideration that the vessel is sailing on a layline course to the waypoint. Data showing time calculations will be indicated with an -S extension:

- DTW-S Sailing Distance to Waypoint
- TTW-S Sailing Time to Waypoint
- ETA-S Sailing Estimated Time of Arrival

SailSteer overlay

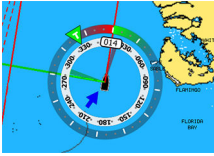

You can overlay the SailSteer image on the Chart. You toggle the SailSteer image overlay on and off in the Chart setting dialog.

- **Note:** If both the SailSteer image and autopilot compass overlays are enabled then only the SailSteer overlay is shown.
- **Note:** SailSteer overlay is not shown when the cursor is activate or when panning the chart. Select the clear cursor option to display the SailSteer overlay again.
- **Note:** If the **Look ahead** menu option is selected, then the **Heading up** orientation must also be selected in order to display the SailSteer overlay. If the **Look ahead** menu option is not selected, then the SailSteer overlay is displayed with all the orientation settings: **North up**, **Heading up**, and **Course up**.



8

Race panel

Use the Race panel to:

- Display and control the race timer
- Create and manage the race start line
- Display race start line data
- Display the race start line in a chart diagram on the Race panel
- Display tactical information for the current leg or next leg

Select the Race button on the Home page to display the Race panel.

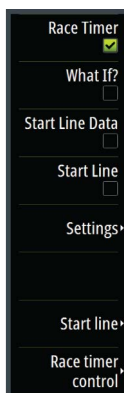
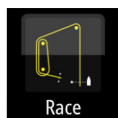

Display options

Use the Race panel menu to specify if you want to display the Race Timer, What if? data, Start Line Data, or Start Line display (display the boat and start line in graphical format).

Start Line on Chart panel

You can display a race start line overlaid on the Chart panel. The start line data can be displayed in the Instrument page. If you have an H5000 CPU on your network, start line data is calculated by the H5000 CPU. Otherwise the data is calculated in the MFD.

Viewing the start line on the chart panel allows the navigator to assess around the starting area for hazards. Use the laylines to see where the likely tracks into and out of the starting area will be relative to the chart data.

The solid black line indicates the start line (between the two starting marks) on the chart panel. You can switch off the start line overlaid on the Chart if desired.

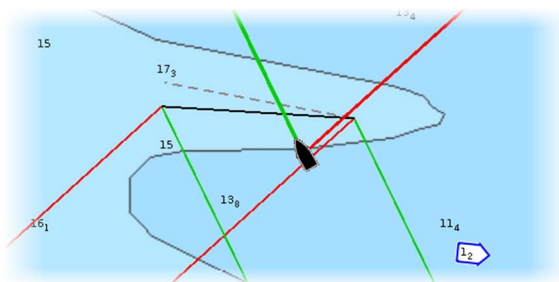

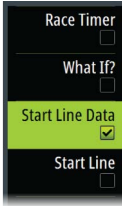

Start Line Data panel

Select the **Start Line Data** menu option to show the Start Line Data panel. The Start Line Data panel shows start line data and a graphical representation of the start line. It displays boat distance from the start line, tide direction, recommended start end bias and what advantage in degrees and distance the biased end will give.

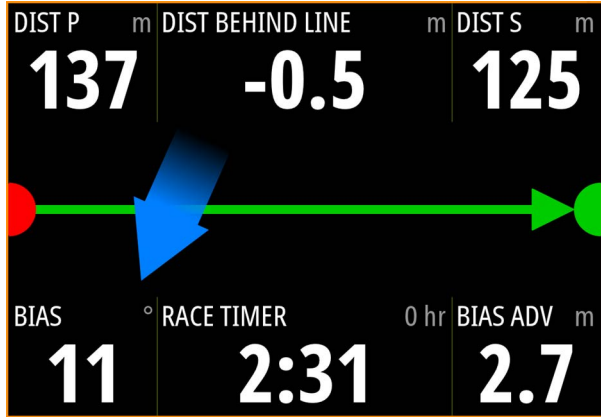

		Start line end not set (position not recorded)
		Start line end set (position recorded)
		Start line end stale (historic start line position) Start line end becomes stale at 23:59 hrs on the day it was recorded but remains valid.
		Invalid start line - One or more ends invalid (position not recorded)
		Start line - Blue - Square line - No bias advantage
		Start line - Red & Arrow left - Port end bias
		Start line - Green & Arrow right - Starboard end bias



Tide direction indicator

Data displayed on start line panel

The following data is displayed on the start line panel:

- DIST P - Distance to port end of start line
- DIST BEHIND LINE - Distance to start line (perpendicular)
- DIST S - Distance to starboard end of start line
- BIAS - Start line bias angle
- RACE TIMER - Time on the race timer
- BIAS ADV - Bias advantage (meters or boat lengths)

Setting up a start line

The start line is a visual aid that shows the distance from the boat to the start line, tide direction, recommended start end bias, and what advantage in degrees and distance the biased end will give. The start line is a line between the port and starboard end points.

→ **Note:** If you have an H5000 CPU on your network, the start line information between the MFD and the H5000 is shared. The start line data numbers are calculated on the H5000 CPU and sent across the network. There is only one start line. If you set the start line on the MFD, it will show on the H5000 Graphic Display and vice-versa.

→ **Note:** Before setting the start line position it is important that the GPS Bow offset is updated to negate the difference between the GPS position and the bow of the vessel. This setting is made in the Advanced settings dialog under Instruments. Your Boat settings must also be entered in the Boat settings dialog which is available from the Chart settings dialog.

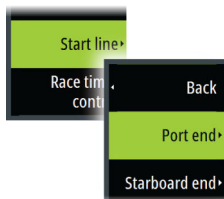

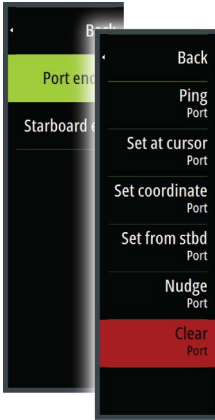

Menu options let you use different methods for setting the port and starboard start line ends. You can *ping* them, set them at cursor position, specify coordinates, and set one based on the setting of the other. You can also edit waypoints to create start line end points. After the ends are set you can *nudge* each end to move them, if needed.

The menu options to set the port and starboard start line end points are available in both the Chart panel and the Race panel.

Setting start line end points by pinging

Setting the start line end points by pinging requires maneuvering the boat to each end of the start line and then pinging.

→ **Note:** Before setting the start line position using the ping method, it is important that the Bow offset is updated to negate the difference between the GPS position and the bow of the vessel.

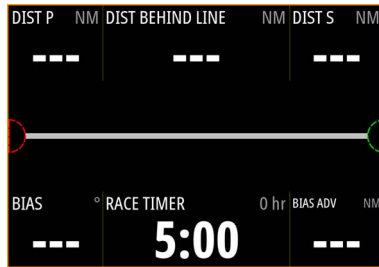

1. Approach the port end of the start line.



2. When the boat reaches the port end of the start line, open the menu and select **Start Line, Port end**, and then **Ping port**. The port end mark on the start line panel becomes solid red, indicating it is set.

3. Approach the starboard end of the start line.



4. When the boat reaches the starboard end of the start line, open the menu and select **Start Line, Starboard end**, and then

Ping Starboard. The starboard end mark on the start line panel becomes solid green indicating it is set.

The start line end points are set and can be viewed on the Chart panel and Start line panel.

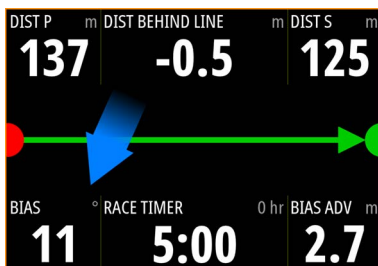

Setting end points at cursor position

1. Open the Chart panel and move the cursor to the position in the chart where you want the port end point to be.
2. Open the menu and select **Start line, Port end**, and then **Set at cursor**.
3. Repeat steps 1 and 2 for the starboard end point.

The start line end points are set and can be viewed on the Chart panel and Start line panel.

Setting end points at coordinates

Select the **Set coordinate Port** and then the **Set coordinate Starboard** menu options to enter the coordinates of the port and starboard end points.

Setting end points from each other

Use the **Set from stbd Port** and **Set from port Starboard** menu options to set the Range and Bearing of the end points from each other.

Removing end points and the start line

Use the **Clear Port** or **Clear Starboard** menu options to remove the start points. When both are removed, the start line is removed.

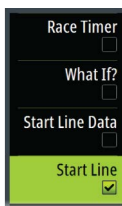

Start Line display

Select the **Start Line** menu option to show the Start Line display in the Race panel. The Start Line display shows the configured start line in scale with your boat, allowing you to clearly see distance to line and position relative to the laylines. All start settings are also shown on this display.

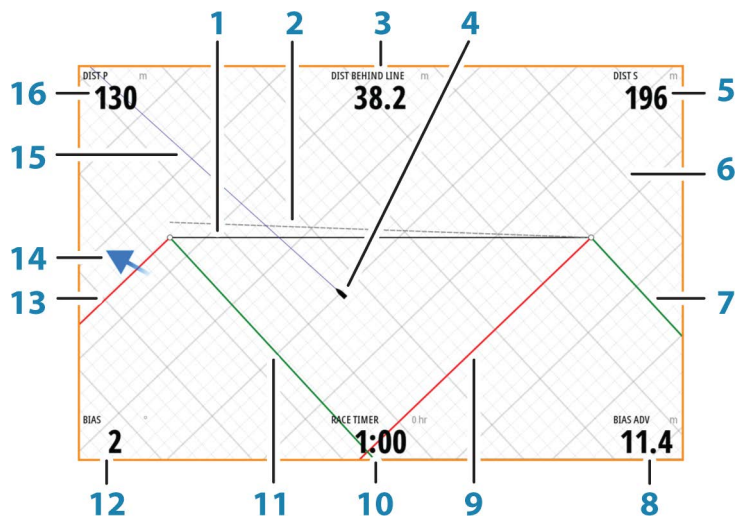

- 1 Start line
- 2 Square wind line - drawn from biased start line end perpendicular to True Wind Direction
- 3 Distance (perpendicular) behind line
- 4 Boat (drawn to scale)
- 5 Distance to starboard end of start line
- 6 Grid
- 7 Starboard tack layline to the starboard start line end point
- 8 Advantage gained by starting at favored end
- 9 Port tack layline to the starboard start line end point
- 10 Race Timer
- 11 Starboard tack laylines to the port start line end point
- 12 Start Line bias angle

- 13 Port tack laylines to the port start line end point
- 14 Tide arrow (relative to start line)
- 15 Extension line
- 16 Distance to port end of start line

In addition, when a target boat speed is available (from the Hercules Polar table, laylines targets table, or manual setting in the Laylines setup, refer to "*Laylines*" on page 51) a Zero Burn line may be shown, parallel with the start line, which indicates the distance you should be from the starting line as time counts down.

Settings

Boat lengths

Select the **Use boat lengths** setting to show the distance behind the line and Bias advantage in boat length data measurements on the Start line panel. Showing the measurements in boat lengths can give a clearer indication of the distance from your boat to the start line.

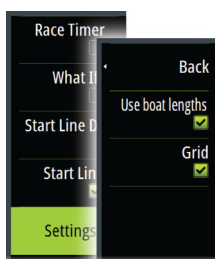

Show layline grids

Select **Grid** to show layline grids in the start line diagram. The grid is a background that is aligned with the laylines. They can give a clearer indication of possible runs to the start line.

What if?

Select the **What if?** in the menu to display navigation data in the Race panel and to change variables to see what could happen. This is a tool for assessing potential changes in wind or tide in current and future legs of the course.

Deselect **Live** and enter parameters for the wind, tide, or both to see how data might change for the leg. For example, if you can see the sea breeze building in with boats sailing different angles on the horizon, you can enter this data to estimate the effect.



Boat to Rpt001		320 °M 9142 NM	
True Wind	008 °M	12.0 kn	<input checked="" type="checkbox"/> Live
Tide	311 °M	20.2 kn	<input checked="" type="checkbox"/> Live
	Port	Starboard	
Heading	342 °M	342 °M	
COG	320 °M	320 °M	
Boat Speed	7.5 kn	7.5 kn	
SOG	27.7 kn	27.7 kn	
TWA	27°	27°	
AWA	16°	16°	
AWS	19.0kn	19.0kn	
Distance	9141.61 NM	9141.61 NM	
Time	330	330	
Prev		Current Leg	Next

Race timer

The race timer can be used to countdown to zero from a specified time, ideal for counting down to a race start. It can also be used to count up from zero to record the elapsed time. You can start and stop the timer, reset it, sync it, and specify a start value.

You can display the Race timer from the Race panel menu, or by selecting Trip Calculator from the Tools panel.

The Timer set value is in hh:mm, the timer counter shows in mm:ss, with the hours showing to the right of the minutes and seconds.

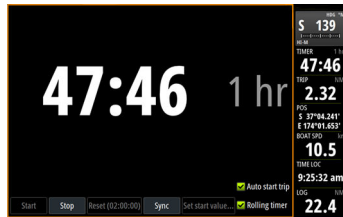
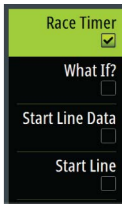

Race timer panel



Race Timer in the Trip Log

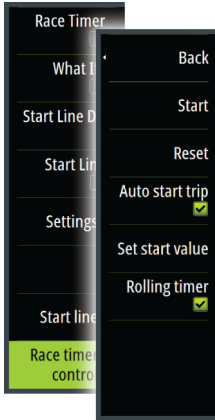

Race timer controls

You can access Race timer controls from the Race panel menu. You can also access them at the bottom of the Race timer panel displayed from the Home page and the Race timer panel displayed from the Trip Calculator (Tool panel). Different controls are enabled depending on if the timer is started or stopped.

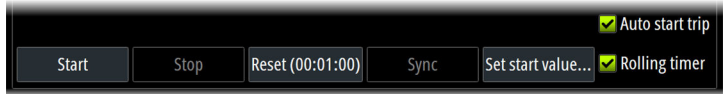

Set start value

Set a time value which the timer shall use to count down to the start time of the race. The timer starts counting down when you select **Start**.

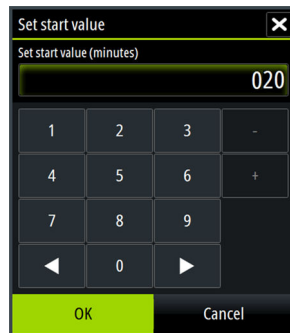

Start/Stop timer

The timer can be started at any time by selecting **Start**. If a time value is preset, the timer counts down. If the start value is set to zero (00:00) when the timer is started, the timer begins counting up, recording the elapsed time.

To stop the timer from counting select **Stop**.

Reset

Resets the timer to the start value. If the timer is running when **Reset** is selected, it continues to run from the start value.

Sync

When the timer is counting down selecting **Sync** synchronizes the time up or down to the nearest full minute.

Auto start trip

When Auto start trip is selected, the Trip Log records your time and mileage from the moment the countdown timer begins counting up from zero.

Rolling timer

When **Rolling timer** is selected, the timer restarts the countdown timer every time it reaches zero. It continues to do this until the timer is stopped.

9

Time and Wind plots

The system can present data history in different plots. The plots can be displayed in full page, or combined with other panels.

The Time plot panel

The Time plot panel consists of two predefined layouts. You switch between the layouts by selecting the left and right panel arrows. You can also select the layout from the menu.

You can select which data to present on a time plot panel, and you can define the time range for each plot.



Layout 1

Layout 2

Missing data

If the data is unavailable, the relevant plot turns into a dashed line and flattens out at the point the data was lost. When the data becomes available again, a dashed line joins up the two points showing an average trend line bridging the missing data.

Selecting data

Each data field can be changed to show the preferred data type and the time range.

1. Select the edit option from the menu
2. Activate the field you want to edit
3. Change the information type and eventually the range
4. Save your changes

The data available for the Time plots are by default the sources used by the system. If more than one data source is available for a data type you can select to show alternative data source in the Time plot.

You change the data type by using the data source option in the menu.

Wind Plot panel

A Wind Plot is a special type of Time Plot specifically designed to help you understand recent changes in wind speed and direction. The Wind Plot panel includes wind direction and wind speed. The graphics are configured vertically with the newest data being displayed at the top of the screen.

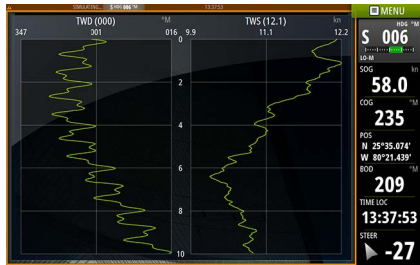

10

PredictWind

PredictWind weather and PredictWind routes can be displayed on charts.

PredictWind weather

PredictWind weather can be displayed as GRIB weather overlay on the chart. To use this functionality, the appropriate PredictWind subscription is required. Refer to www.predictwind.com.

Only one weather file can be displayed on the chart at a time.

The PredictWind GRIB weather file can be made available for display as overlay on the chart the following ways:

- Download PredictWind files automatically or manually from the PredictWind web site using the unit's Internet connection as follows:
 - Turn on GRIB weather overlay from the Chart menu, refer to *"Turn on GRIB weather overlay"* on page 87
 - Enter your PredictWind login credentials in the unit, refer to *"PredictWind login credentials"* on page 87
 - If you want the system to automatically download the files from PredictWind, specify automatic download High resolution, Offshore (lower resolution), or both. Refer to *"Automatically download PredictWind weather files"* on page 88.
 - If you want to manually download the files from PredictWind, use the Download forecast option in the Chart menu. Refer to *"Manually download PredictWind weather files"* on page 88.
 - Import the file into memory to overlay it on the chart, refer to *"Specify PredictWind GRIB overlay file"* on page 91
- Download PredictWind files to a memory card connected to a PC and then import a file from the memory card into the unit's memory as follows:
 - Download PredictWind weather files to a memory card connected to a PC
 - Note:** Do not use a map memory card. Downloading files to a map card can corrupt the map card.
 - Insert the memory card in the unit's card reader
 - Turn on GRIB weather overlay from the Chart menu, refer to *"Turn on GRIB weather overlay"* on page 87

- Import the file into memory to overlay it on the chart. You can import a weather file directly from the memory card or from any directory available to the File manager. Refer to Specify PredictWind GRIB overlay file "*Specify PredictWind GRIB overlay file*" on page 91.

Turn on GRIB weather overlay

To view GRIB weather overlay on the chart and expand the chart menu to display GRIB weather menu options, turn on the GRIB weather overlay feature from the chart menu.

PredictWind login credentials

To automatically or manually download weather files from the PredictWind web site, enter your PredictWind login credentials in the PredictWind GRIB weather dialog.

Access the PredictWind GRIB weather dialog from the Chart settings dialog.

Select Email and enter your PredictWind login email address.

Select Password and enter your PredictWind password.

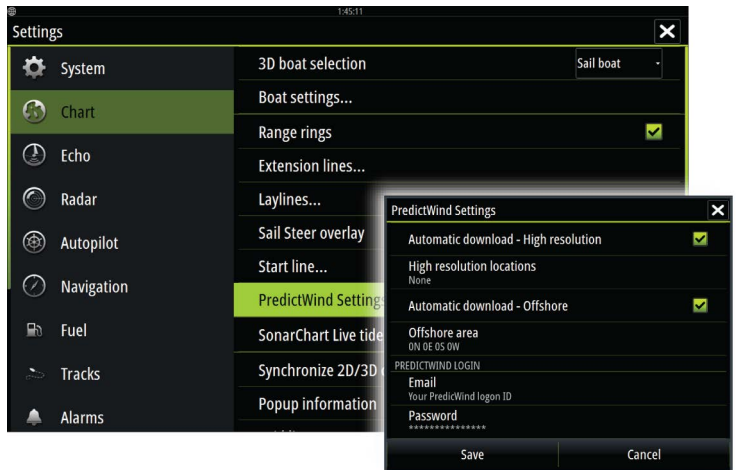

Automatically download PredictWind weather files

The automatic download feature allows your system to regularly check for weather updates and download the latest data.

Specify if you want to automatically download High resolution (refer to "*High resolution*" on page 89) or Offshore - lower resolution (refer to "*Offshore area (lower resolution)*" on page 89) or both types of GRIB data.

- **Note:** High Resolution downloads require a PredictWind Professional subscription.
- **Note:** To download data from PredictWind, the unit must have an internet connection and your PredictWind login credentials must be entered in the system (refer to "*PredictWind login credentials*" on page 87). When an internet connection is made the system will automatically login to PredictWind with your credentials and start downloading weather data as specified in the PredictWind GRIB Weather dialog.

Manually download PredictWind weather files

To download a PredictWind weather file manually, select the Download forecast option in the Chart menu to display the Select forecast type dialog. Use the Select forecast type dialog to specify the type and area.

- **Note:** To manually download data from PredictWind, the unit must have an internet connection. The Download forecast option is only available if you have turned on GRIB weather overlay on the Chart menu (refer to "*Turn on GRIB weather overlay*" on page 87), and your PredictWind login credentials are entered in the system (refer to "*PredictWind login credentials*" on page 87).

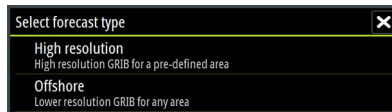

When the GRIB download is complete, the MFD will display a message to show the task is complete. To view the downloaded GRIB file on the chart, select the downloaded file from the **Forecast** menu option. Refer to "*Specify PredictWind GRIB overlay file*" on page 91.

High resolution

Download location areas are displayed on the chart. Select or deselect single or multiple locations. The selected areas are highlighted. You can add and remove locations by selecting Automatic download locations later.

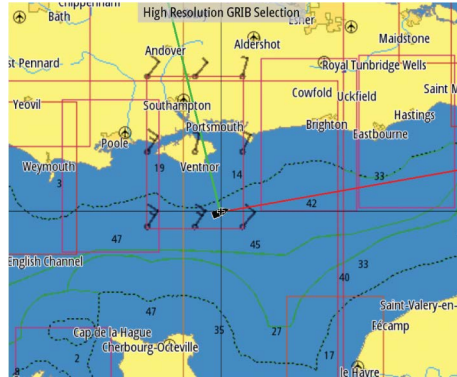

Specify the settings for the high resolution GRIB download, refer to *"PredictWind download settings"* on page 90.

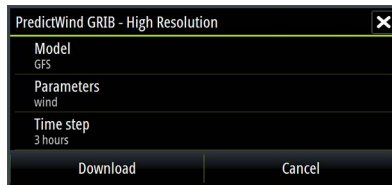

Offshore area (lower resolution)

The chart is displayed when you select the offshore area (lower resolution) option with an expandable rectangle. Drag the rectangle's corner markers to create the area rectangle you want to download GRIB weather for.



After you create your offshore area rectangle, choose the **Select** option.

Specify the settings for the offshore (lower resolution) GRIB download, refer to "*PredictWind download settings*" on page 90.

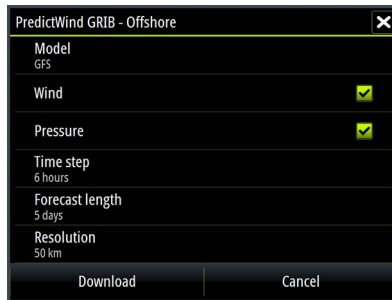

PredictWind download settings

Model

Allows you to select from the GRIB model options:

- PWE (PredictWind Forecast) - PredictWind forecast based on the weather observation from the European Centre for Medium-Range Weather Forecast.
- GFS (Global Forecast System) - a weather observation file from the National Oceanic and Atmospheric Administration (NOAA) of the USA Department of Commerce.
- ECMWF (European Center for Medium-Range Weather Forecasts) - a weather observation file from the European Centre for Medium-Range Weather Forecast. Available for Offshore GRIB only.
- GFSF (Global Forecast System Forecast) - PredictWind forecast based on the weather observation from the National Oceanic and Atmospheric Administration (NOAA) of the USA Department of Commerce. Available for Offshore GRIB only.

Wind and Pressure

The wind and/or pressure data from PredictWind. Available for Offshore GRIB only.

Time step

The size of the time step in the downloaded forecast. For example, a 3 hour time step could provide weather data for 1200, 1500, 1800 etc., where a 6 hour time step could only provide 1200, 1800 etc. Smaller steps require larger downloads.

Forecast length

The period of the forecast in days.

Resolution

GRIB resolution, select 50 or 100 kilometers between forecast points. Available for Offshore GRIB only.

Specify PredictWind GRIB overlay file

The Forecast menu option shows the GRIB file which is currently displayed on the chart. If no file is displayed on the chart, then the menu option does not show a GRIB file.

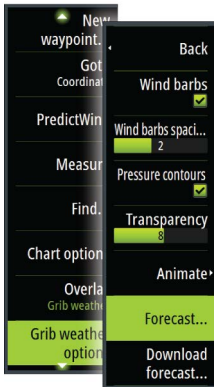

GRIB file displayed on the chart



No GRIB file displayed on the chart

Select the Forecast menu option to open the GRIB Weather dialog.

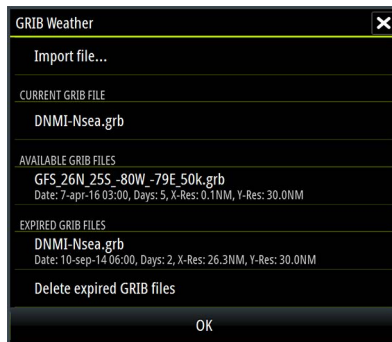

The GRIB Weather dialog shows which GRIB file is currently displayed as overlay on the chart and which files are available for display.

Available GRIB files are files downloaded manually or automatically from PredictWind to the Gribs directory. If you copy GRIB files from the memory card to the Gribs directory using the file manager, they will be listed as available GRIB files.

Select an available GRIB file to import it into memory and display it as overlay on the chart. Select the Import file option to import a GRIB file into memory from the memory card or any directory available to the File manager.

→ **Note:** GRIB data that is imported overwrites the GRIB data in memory.

Expired GRIB files

The system identifies GRIB files that have expired and moves them from the available GRIB files list to the expired GRIB files list. Expired files are files where the time of the final forecast has passed. Select the Delete expired GRIB files option to delete these expired files from the system.

PredictWind weather routing and departure planner

PredictWind Weather routing is an online weather routing service for creating the fastest or safest route for your trip based on weather conditions.

The departure planner is an online service that advises the best day to depart on a coastal or offshore trip. It summarizes the wind conditions you will encounter the next 4 days of departure.

PredictWind routing can also provide a weather forecast for your destination. This information is available in the Summary panel.

Requirements

- Internet connection – the unit must have an internet connection
- Appropriate PredictWind subscription/account, refer to www.predictwind.com.
- PredictWind login credentials entered in the PredictWind settings dialog.

- Your boat performance details are entered in the polar table at www.predictwind.com. Polars define the performance of your boat in different wind and wave conditions. It is important to define this accurately, so the optimal route is as accurate as possible.

Set up and usage

1. Connect your unit to the internet. Refer to "*Connect and disconnect from a wireless hotspot*" on page 162.
2. Enter your PredictWind credentials in the PredictWind settings dialog.

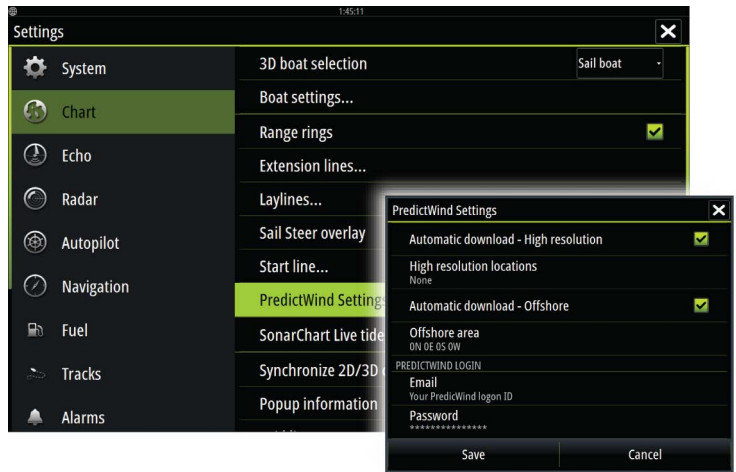

3. Launch the PredictWind routing feature, the following options are available:

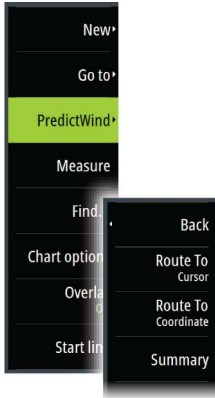

- Route to cursor
 - a. Activate the cursor on the chart.
 - b. Select the PredictWind menu option.
 - c. Select **Route to cursor** to specify route to cursor information. For specifying details refer to "*PredictWind Routing dialog options*" on page 95.
 - d. Select Download to request a new route from PredictWind.
- Route to coordinate
 - a. Select the PredictWind menu option.
 - b. Select **Route to coordinate** to display the PredictWind Routing dialog.
 - c. Select the **Destination** option to set the destination coordinate and select OK. The PredictWind Routing dialog opens showing the destination coordinate you specified.
 - d. Select options in the PredictWind Routing dialog to specify route to coordinate information. For specifying details refer to "*PredictWind Routing dialog options*" on page 95.
 - e. Select Download to request a new route from PredictWind.
- Route to waypoint
 - a. Do one of the following:
 - Use the Find menu option, select Waypoints and then select the waypoint in the list to open the Edit Waypoint dialog.
 - Select **Waypoints** in the Tool panel dialog and select the waypoint in the list to open the Edit Waypoint dialog.
 - Select the **Waypoint** on the chart. This lists the selected waypoint in the menu. Select the waypoint in the menu and then Details in the expanded menu to open the Edit Waypoint dialog.
 - b. Select **PredictWind** to specify route to waypoint information. For specifying details refer to "*PredictWind Routing dialog options*" on page 95.
 - c. Select Download to request a new route from PredictWind.

- Use existing route
 - a. Do one of the following:
 - Use the Find menu option and select the route in the list to open the Edit Route dialog.
 - Select **Routes** in the Tool panel dialog and select the route in the list to open the Edit Route dialog.
 - Select the **Route** on the chart. This lists the selected route in the menu. Select the route in the menu and then Details in the expanded menu to open the Edit Route dialog.
 - b. Select **PredictWind** to specify routing information. For specifying details refer to *"PredictWind Routing dialog options"* on page 95.
 - c. Select Download to request a new route from PredictWind.

If there is an internet connection and proper account credentials entered in the PredictWind settings dialog, a route will be downloaded from PredictWind.

PredictWind Routing dialog options

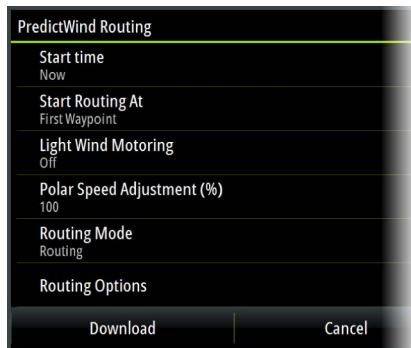

Start Time

Specify the start date and time. If **Now** is selected, the date and time options are disabled.

Start Routing At

Specify to PredictWind if you want weather routing to start from the current vessel position or to start weather routing at the first waypoint in the route.

Light Wind Motoring

Specify light wind motoring options:

- Motoring speed
- The wind speed at which you would stop sailing and start motoring

Polar Speed Adjustment

Adjust the polar speed by a percentage. If, for example, you are delivering a boat short handed and expect the boat performance to be slower than your Polar by 20%, apply 80% to the Polar Speed Adjustment.

Routing Mode

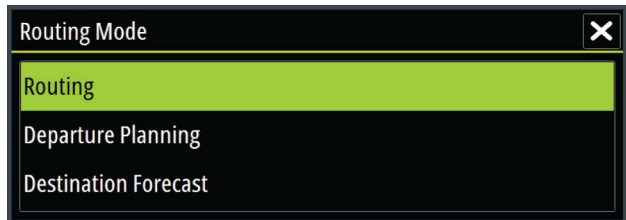

You can select one of the following modes:

- **Routing** - Opens the PredictWind Routing dialog with **Routing Options** enabled. Select **Routing Options** to specify the wind speeds and swells you want to avoid on the route.
- **Departure Planning** - Opens the PredictWind Routing dialog with **Departure Options** enabled. Select **Departure Options** to specify the time you want to space the departures (1 hour, 3 hours, 6 hours, 12 hours or 24 hours) and the forecast model (GFS/ECMWF or PWE/PWG) you want PredictWind to use.
- **Destination Forecast** - Select this option to request destination forecast information from PredictWind.

Routing and destination forecast details are provided in the Summary panel.

Download Management

To view the status of any ongoing route downloads select the Files icon on the Tool panel and then Transfers to see transfer status. When a download completes, the route is drawn on the chart. Old routes are deleted when the new route becomes available. If a route is being followed when a new one is downloaded it will continue to be followed until navigation is finished.

PredictWind routing summary

Select the Summary option in the PredictWind menu to view detailed routing information.

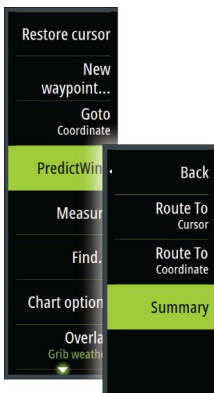

PredictWind Routing Summary					
	Summary	Wind	Current	Route	Swell
	PWG	PWE	GFS	ECMWF	
Start Time	04/07/2017 11:29	04/07/2017 11:29	04/07/2017 11:29	04/07/2017 11:29	04/07/2017 11:29
Finish Time	05/07/2017 04:17	05/07/2017 02:49	05/07/2017 02:56	05/07/2017 02:56	05/07/2017 02:56
Time Taken	0d 16h 48m 26s	0d 15h 19m 47s	0d 15h 26m 59s	0d 15h 26m 59s	0d 17h 22m 11s
Max Wind Speed (kph)	19.61	19.50	16.91	16.91	14.96
Min Wind Speed (kph)	4.02	6.76	5.89	5.89	3.63
Avg Wind Speed (kph)	8.82	11.01	11.53	11.53	7.50

Follow

Additional summary information is available for wind, current, route, and swell.

Select **Follow** to sail the route.

11

Autopilot

If a compatible autopilot computer is connected to the system, autopilot functionality is available in the system.

The system does not allow for more than one autopilot computer on the network.

The display unit automatically detects the autopilot computer available on the network and presents settings, configuration and user options for the connected computer.

For details about installing and configuring an autopilot computer, refer to the separate manuals that come with the autopilot computer.

Safe operation with the autopilot

⚠ Warning: An autopilot is a useful navigational aid, but DOES NOT replace a human navigator.

⚠ Warning: A physical standby key should be available for the autopilot.

Activating the autopilot

Activate the autopilot from any panel by selecting the autopilot option in the Control bar, followed by selecting a mode in the Autopilot controller.

The autopilot can also be activated in navigation mode from applications when you select to navigate to the cursor, a waypoint, or a route.

Switching from automatic mode to manual steering

You switch the autopilot to Standby mode from any automatic operation mode from the Autopilot controller or using a physical standby key.



Autopilot indication on the pages



- 1 Control bar
- 2 Autopilot controller
- 3 Autopilot indication in Status bar

S HDG 007 °M

Autopilot mode indication in the Status bar

The Status bar shows autopilot information as long as an autopilot computer is connected to the network.

Icons are included if the autopilot is passive or locked by another autopilot control unit.

Autopilot controller

Select Autopilot in the Control bar to activate the Autopilot controller.

The Autopilot controller has a fixed position on the left-side of the page.

Close the Autopilot controller by selecting Close/Back on the Autopilot controller.

The Autopilot controller can also be closed by selecting Autopilot or another button on the Control bar.

Open it again by selecting Autopilot on the Control bar.

The following Autopilot controller pages are available:

- Autopilot controller, showing active mode, heading, rudder and various steering information depending on active autopilot mode. Manual adjustments to the set heading can only be made when the port and starboard arrow indicators are illuminated red and green.
- Mode selection, includes access to tack or gybe options.
- Tack or Gybe selection, available when in Heading hold or Wind mode and boat type is set to Sail in the Autopilot commissioning dialog. Refer to *"Tacking in AUTO mode"* on page 103. Also see *"Tacking in WIND mode"* on page 106.

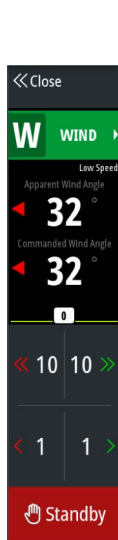

Autopilot controller

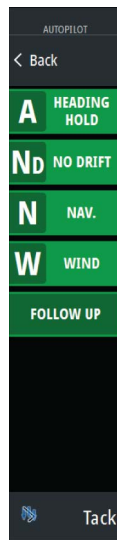

Mode selection



Start tack

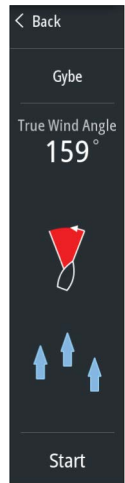

Start gybe

The Autopilot panel

The autopilot panel is used to display navigation data. It can be shown as a full screen panel, or in a multi-panel page.

- **Note:** To make the autopilot panel available, activate the show autopilot features option in the Advanced, Features section of the System Settings dialog.

The number of data fields included in the autopilot panel is dependent on available panel size.



Data fields

The following abbreviations are used in the autopilot panel:

CTS	Course to steer
DTD	Distance to destination
WPT	Distance to next waypoint
DIST	
SOG	Speed over ground
COG	Course over ground
XTE	Cross track error (L: left or R: right)

Autopilot modes

The autopilot has several steering modes. The number of modes and features within the mode depend on the autopilot computer, the boat type and available inputs, as explained in the description of the following steering modes.

Standby mode

Standby mode is used when you steer the boat at the helm. Switch the autopilot to Standby mode from any operation by selecting the Standby mode button in the Autopilot controller or using a physical standby key.

Non-Follow Up (NFU, Power steering)

In NFU mode you use the port and starboard arrow buttons in the Autopilot controller to control the rudder. The rudder will move as long as the button is pressed.

- Activate NFU mode by selecting the port or starboard arrow button in the Autopilot controller when the autopilot is in Standby or FU mode.

You return to Standby mode by selecting the standby option in the Autopilot controller or using a physical standby key.

Follow-up steering (FU)

- **Note:** FU mode is only available if you have a remote controller included in the system. The MFD unit does not have a rotary knob.

In FU mode you use the rotary knob to control the rudder angle. Press the rotary knob, then turn the knob to set the rudder angle. The rudder moves to the commanded angle and then stop.

- You select FU mode from the Autopilot controller
- **Note:** If the Autopilot controller is closed or if an alarm dialog is activated on the unit controlling the autopilot in FU mode, the autopilot automatically changes to Standby mode.

⚠ Warning: While in FU mode you cannot take manual control of the wheel.

AUTO mode (Heading hold)

In AUTO mode (Heading hold) the autopilot issues rudder commands required to steer the vessel automatically on a set heading.

Switch to AUTO mode by selecting the Heading hold mode option in the Autopilot controller. When the mode is activated, the autopilot selects the current boat heading as the set heading.

Changing set heading in AUTO mode (Heading hold)

You adjust the set heading by using the Port and Starboard arrow buttons in the Autopilot controller.

An immediate heading change takes place. The new heading is maintained until a new heading is set.

Heading capture

When the vessel is turning in AUTO mode, an instant reset of the mode activates the heading capture function. This automatically cancels the turn, and the vessel continues on the heading read from the compass the very moment you re-activated the mode.

Tacking in AUTO mode

→ **Note:** The tack function is only available when the boat type is set to SAIL.

→ **Note:** Tacking should be tried out in calm sea conditions with light wind to find out how it works on your boat. Due to a wide range of boat characteristics (from cruising to racing boats) the performance of the tack function may vary from boat to boat.

Tacking in AUTO mode (Heading hold) is different from tacking in WIND mode. In AUTO mode the tack angle is fixed and as defined by the user. For more details, refer to "*Tacking in WIND mode*" on page 106.

You initiate the tack function from AUTO mode.

When tacking direction is selected the autopilot changes the current set course according to the set fixed tacking angle.

NoDrift mode

NoDrift mode combines the autopilot and the positioning information from the GPS.

In NoDrift mode the vessel is steered along a calculated track line in a direction set by the user. If the vessel's heading is drifting away from the original heading due to current and/or wind, the vessel follows the line with a crab angle.

1. Turn the vessel to the desired heading
2. Activate the NoDrift mode. The autopilot draws an invisible bearing line based on current heading from the boat's position

Unlike in AUTO mode (Heading hold), the autopilot now uses the position information to calculate the cross track error, and automatically keeps your track straight.

You use the port/starboard arrow panel buttons in the Autopilot controller to reset the bearing line while in NoDrift mode.

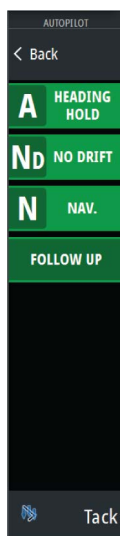

Dodging

If you need to avoid an obstacle when using NoDrift mode, you can set the autopilot to Standby mode and power steer or use the helm until the obstacle is passed.

If you return to NoDrift mode within 60 seconds you can select to continue on previous set bearing line.

If you do not respond, the dialog disappears and the autopilot goes to NoDrift mode with current heading as set bearing line.

NAV mode

⚠ Warning: NAV mode should only be used in open waters.

You can use the autopilot to automatically steer the boat to a specific waypoint location, or along a pre-defined route. The position information from the GPS is used to change the course to steer to keep the boat on the track line and to the destination waypoint.

→ **Note:** To obtain satisfactory navigation steering, the Vulcan Series must have valid position input. Autosteering must be tested and determined satisfactory prior to entering the NAV mode.

Start automatic navigating

When you start navigating a route or to a waypoint from the chart panel, you are prompted to set the autopilot to NAV mode. If you reject this request, you can start NAV mode from the Autopilot controller.

→ **Note:** The prompt to set the autopilot to navigation mode is disabled if the boat type is set to SAIL in the Autopilot Commissioning dialog. To start navigating, you must select NAV mode from the Autopilot controller.

When NAV mode is initiated, the autopilot automatically keeps the vessel on the leg.

When the vessel reaches the arrival circle for a routepoint, the autopilot gives an audible warning and displays a dialog with the new course information. If the required course change to the next

waypoint is less than the Navigation change limit, the autopilot automatically changes the course. If the required course change to next waypoint in a route is more than the set limit, you are prompted to verify that the upcoming course change is acceptable.

→ **Note:** For information about navigation settings, refer to "*Navigation settings*" on page 69.

Waypoint arrival circle

The Arrival radius defines the point at which a turn is initiated when you are navigating a route.

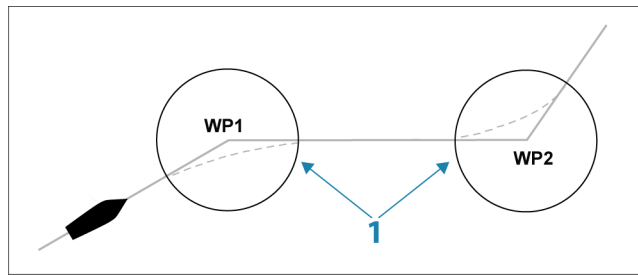

The arrival circle (**1**) should be adjusted according to boat speed. The higher the speed, the wider the circle. The intention is to make the autopilot start the heading change in due time to make a smooth turn onto the next leg.

The figure below may be used to select the appropriate waypoint circle when creating the route.

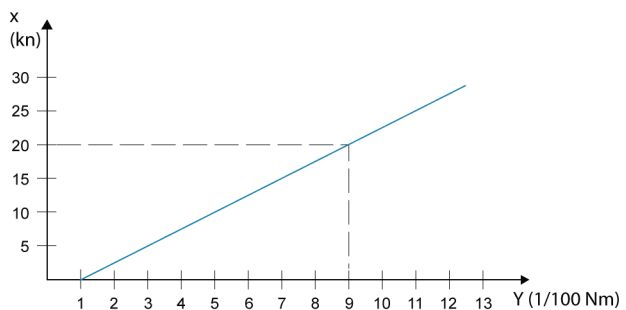

X axis = Boat speed in knots

Y axis = Arrival circle, radius in 1/100 Nm

Example: With the speed of 20 knots you should use a waypoint circle with radius 0.09 Nm.

→ **Note:** The distance between any waypoints in a route must not be smaller than the radius of the waypoint arrival circle.

WIND mode

→ **Note:** WIND mode is only available if the system has been set up for boat type SAIL in the Autopilot Commissioning dialog. It is not possible to active WIND mode if wind information is missing.

When wind mode is engaged, the autopilot captures the current wind angle as steering reference, and adjusts the heading of the boat to maintain this wind angle.

Switch to WIND mode by selecting it in the Autopilot controller.

⚠ Warning: In wind mode the autopilot steers to the apparent or true wind angle and not to a compass heading. Any wind shift could result in the vessel steering on an undesired course.

Tacking in WIND mode

→ **Note:** The tack function in WIND mode is only available when the system is set up for boat type SAIL in the Autopilot Commissioning dialog.

Tacking in Wind mode can be performed when sailing with apparent or true wind as the reference. In either case the true wind angle must be less than 90 degrees.

The tacking/gybing operation will mirror the set wind angle on the opposite tack.

→ **Note:** Tacking should be tried out in calm sea conditions with light wind to find out how it works on your boat. Due to a wide range of boat characteristics (from cruising to racing boats) the performance of the tack function may vary from boat to boat.

The rate of turn during the tack will be given by the Tack time defined in the sailing parameter setup. The tack time is also



controlled by the speed of the boat to prevent loss of speed during a tack.

You can initiate the tack function from WIND mode.

When you initiate the tacking, the autopilot immediately mirrors the set wind angle to the opposite side of the bow.

You can interrupt the tack operation by selecting standby, re-engaging Wind mode, or engaging heading hold or no drift.

Gybing

Gybing is possible when the true wind angle is larger than 120°.

The time to make a gybe is determined by the speed of the boat to make it as quick as possible within control.



Autopilot settings

The autopilot settings can be split between settings done by the user, and settings done during installation and commissioning of the autopilot system.

- User settings can be changed for various operational conditions or user preferences
- Installation settings are defined during commissioning of the autopilot system. No changes should later be done to these settings

Both user settings and installation settings depends on which autopilot computer that is connected to the system.

The following sections describe the settings that can be changed by the user. Installation settings are available in the documentation included with the autopilot computer.

Common user settings

The following user settings are common to all autopilots.

Chart compass

You can select to show a compass symbol around your boat on the chart panel. The compass symbol is off when the cursor is active on the panel.

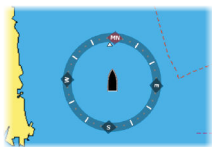

Locking autopilot operation from a unit

You can lock a unit to prevent unauthorized operation of the autopilot. When the unit is locked, it is indicated with a lock symbol

and with text in the Autopilot controller. No automatic modes can be selected from a locked display.

→ **Note:** The lock function is not available on a unit which has autopilot control!

H5000 Specific user settings

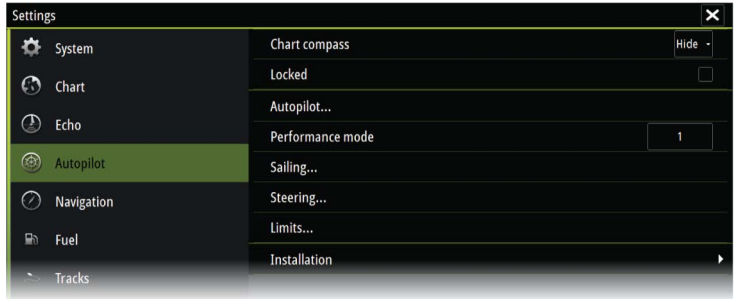

Performance

The Performance controls the response of the autopilot steering. There are five levels of performance modes:

- Level one consumes the least amount of power when steering the autopilot and offers the slowest response
- Level five consumes the most power and has the highest response



The performance mode is indicated in the top right corner of the status display in the Autopilot controller.

Sailing

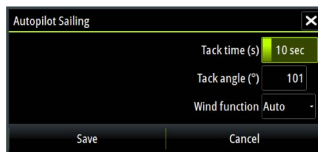

This option allows for manually changing parameters that were set during the commissioning of the autopilot computer. For more details of the settings, refer to the separate documentation for the autopilot computer.

- Tack time: Controls the rate of turn (tack time) when performing a tack in AUTO and Wind mode.
- Tack angle: Controls the angle that the boat will tack to between 50° - 150° in AUTO mode
- Wind function: Select what wind function the autopilot will use when in wind mode
 - Auto:
 - If TWA is <70°: Wind mode will use AWA
 - If TWA is ≥70°: Wind mode will use TWA
 - Apparent
 - True

Steering

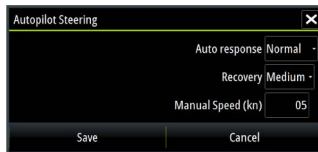

This option allows for manually changing parameters that were set during the commissioning of the autopilot computer. For more details of the settings, refer to the separate documentation for the autopilot computer.

- Auto response: controls the rate that which the autopilot reacts to any environmental influences on the vessels desired course
 - Off: The autopilot will always remain in the response mode selected
 - Economy: The autopilot will need to sense large environmental changes before increasing the response setting
 - Normal: The autopilot will need to sense moderate environmental changes before increasing the response settings
 - Sport: The autopilot will be most sensitive to changing conditions and will automatically increase its response rate to counter environmental changes
- Recovery: Allows the user to set the sensitivity to course errors and how the autopilot will react to unexpected events, for example sudden wave or wind shifts. This function allows the autopilot to instantaneously increase the steering response to its

maximum setting (Perf 5), and make a rapid recovery. The Recovery will automatically switch off after 15 seconds or when the heading error has been corrected. The autopilot will then resume the previous response setting and continue normal operation.

- Off
 - Narrow: The autopilot is most sensitive to sudden course changes corrected
 - Medium: The autopilot is configured to the medium value when correcting sudden course changes
 - Wide: The autopilot is least sensitive to sudden course changes
- Manual speed: If neither boat speed or SOG data is available and or deemed reliable a manual value for speed source can be entered and used by the autopilot to aid steering calculations

Limits

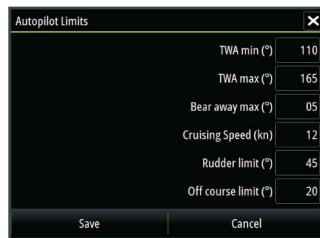

This option allows for manually changing parameters that were set during the commissioning of the autopilot computer. For more details of the settings, refer to the separate documentation for the autopilot computer.

Allows control of the True Wind Angle range where Gust and True Wind Speed response can be configured and controlled.

- TWA min: Minimum True Wind Angle that gust and True Wind Speed response operate in.
- TWA max: Maximum True Wind Angle that gust and True Wind Speed response operate in.
- Bear away max: Maximum angle the vessel will bear away during stability control
- Cruising speed: The preferred cruising speed for this vessel (comfortable and economical)

- Rudder limit: Determines the maximum rudder movement in degrees from midship position that the autopilot can command the rudder in the automatic modes. The Rudder limit setting is only active during autosteering on straight courses, NOT during course changes. Rudder limit does not affect Non-Follow-up steering.
- Off course limit: Defines the limit for the off course alarm

NAC2/NAC3 Specific user settings

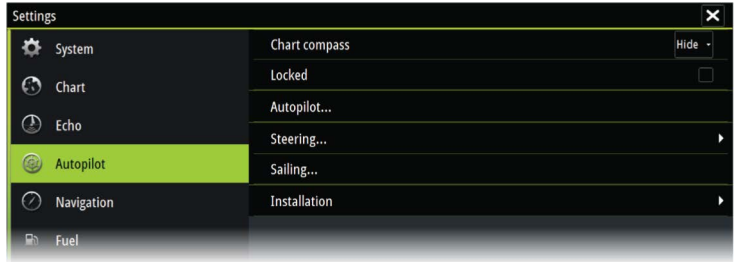

Steering

These options allow for manually changing low speed and high speed parameters that were set during the commissioning of the autopilot computer. For more details, refer to the separate documentation for the autopilot computer.



Selecting the low speed option or the high speed option opens dialogs the following parameters can be changed.

- Turn rate: Preferred turn rate used while turning in degrees per minute
- Rudder gain: This parameter determines the ratio between commanded rudder and the heading error. The higher rudder value the more rudder is applied. If the value is too small it will take a long time to compensate for a heading error, and the autopilot will fail to keep a steady course. If the value is set too

high the overshoot will increase and the steering will be unstable.

- Counter rudder: Relation between change in heading error and applied rudder. Higher counter rudder will reduce applied rudder faster when approaching the set heading
 - Auto trim: Controls how aggressively the autopilot will apply rudder to compensate for a constant heading offset, e.g. when external forces such as wind or current affects the heading. Lower auto trim will give faster elimination of a constant heading offset
- **Note:** In VRF mode this parameter controls the time constant of the rudder estimate. A lower value makes the rudder estimate faster, i.e. that it will more quickly catch up with the boat's movements.
- Init rudder: Defines how the system moves the rudder when switching from manual steering to an automatic mode.
 - Center: Moves the rudder to zero position
 - Actual: Maintains the rudder offset
 - Rudder limit: Determines the maximum rudder movement in degrees from midship position that the autopilot can command the rudder in the automatic modes. The Rudder limit setting is only active during autosteering on straight courses, NOT during course changes. Rudder limit does not affect Non-Follow-up steering
 - Off heading limit: Sets the limit for the off heading alarm. An alarm occurs when the actual heading deviates from the set heading more than the selected limit
 - Track response: Defines how fast the autopilot shall respond after having registered a cross track distance
 - Track approach angle: Defines the angle used when the vessel is approaching a leg. This setting is used both when you start navigating and when you use track offset
 - Course change confirm angle: Defines the limits for course change to next waypoint in a route. If the course change is more than this set limit, you are prompted to verify that the upcoming course change is acceptable.

Sailing

→ **Note:** Sailing parameters are only available when the boat type is set to Sail.

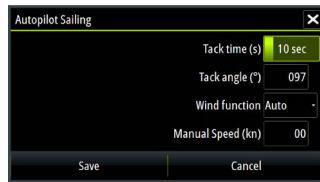

This option allows for manually changing parameters that were set during the commissioning of the autopilot computer. For more details of the settings, refer to the separate documentation for the autopilot computer.

- Tack time: Controls the rate of turn (tack time) when performing a tack in wind mode.
- Tack angle: Controls the angle that the boat will tack to between 50° - 150° in AUTO mode
- Wind function: Select what wind function the autopilot will use when in wind mode
 - Auto:
 - If TWA is <70°: Wind mode will use AWA
 - If TWA is ≥70°: Wind mode will use TWA
 - Apparent
 - True
- Manual speed: If neither boat speed or SOG data is available and or deemed reliable a manual value for speed source can be entered and used by the autopilot to aid steering calculations

12

Radar

→ **Note:** Radar is available if the unit has a Radar connection on the back.

The radar panel can be set up as a full screen view or combined with other panels.

The radar image can also be displayed as an overlay on a chart panel. For more information, see "*Chart overlay*" on page 38.

→ **Note:** Radar overlay requires data from a heading sensor or compass to ensure proper orientation with the chart.

The radar panel

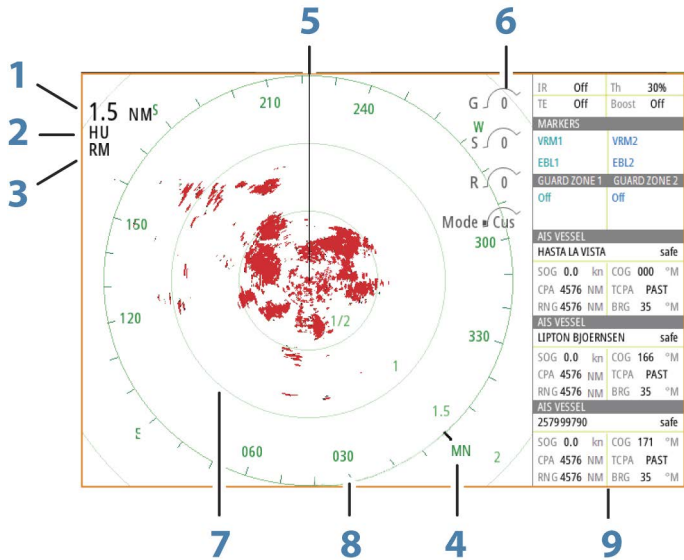

- 1 Range
- 2 Orientation
- 3 Motion
- 4 Compass*
- 5 Heading line*
- 6 Rotary controls

- 7 Range rings*
- 8 Range markers*
- 9 Data bar

* Optional radar symbology.

Radar symbology can be turned ON/OFF collectively from the Radar menu, or individually as described in "*Radar settings panel*" on page 131.

Dual radar

You can connect to any combination of two supported radars and see both radar images at the same time.

→ **Note:** Interference will be seen on the Broadband Radar on most ranges when a pulse and a Broadband radar are transmitting at the same time on the same boat. We recommend to only transmit on one radar at a time. For example, transmit Broadband radar for typical navigational usage, or pulse radar to locate weather cells, defined coastlines at a distance and to trigger Racons.

You can select a dual radar panel by pressing and holding the Radar application button on the **Home** page, or by creating a favorite page with two radar panels.

Selecting the radar source

You specify the radar in the Radar panel by selecting one of the available radars in the radar source menu option. If you have a multiple Radar panel, the radar is set individually for each radar panel. Activate one of the radar panels, and then select one of the available radars in the radar source menu option. Repeat the process for the second radar panel, and select an alternative radar for this panel.

→ **Note:** The 3-digit radar source number is the last 3 digits of the radar's serial number.

Radar overlay

You can overlay the Radar image on the Chart. This can help you to easily interpret the radar image by correlating the radar targets with charted objects.

→ **Note:** A heading sensor must be present in the system for radar overlay.

When the radar overlay is selected, basic radar operational functions are available from the Chart panel's menu.

Selecting radar overlay source on chart panels

To select the radar source of the radar overlay displayed on the chart panel, use the **Radar options** and then **Source** chart panel menu options to select the radar source.

For chart pages with more than one chart with radar overlay, it is possible to set up different radars sources for each chart panel. Activate one of the chart panels and then select one of the available radars in the radar source menu option. Repeat the process for the second chart panel with radar overlay, and select an alternative radar for this panel.

Radar operational modes

The radar's operational modes are controlled from the Radar menu. The following modes are available:

Power off

The power to the radar scanner is turned off. **Power off** is only available when radar is in standby mode.

Standby

The power to the radar scanner is on, but the radar is not transmitting.

→ **Note:** You can also put the radar in standby mode from the **System Controls** dialog.

Transmit

The scanner is on and transmitting. Detected targets are drawn on the radar PPI (Plan Position Indicator).

→ **Note:** You can also put the radar in transmit mode from the **System Controls** dialog.

Radar Range

You adjust radar range by selecting the zoom icons on the radar panel.

Dual range

(Broadband 4G Radar only)

When connected to a Broadband 4G radar, it is possible to run the radar in Dual Range mode.

The radar appears in the radar sources menu as two virtual radar sources A and B. Range and radar controls for each virtual radar source are fully independent and the source can be selected for a particular chart or radar panel in the same manner as dual radar described in "*Selecting the radar source*" on page 115.

→ **Note:** Some controls that are related to physical properties of the radar itself are not independent of source. These are Fast Scan, Antenna Height and Bearing alignment.

MARPA is fully independent and up to 10 targets may be tracked for each virtual radar source.

Up to two independent Guard Zones may also be defined for each virtual radar source.

Using the cursor on a radar panel

By default, the cursor is not shown on a radar panel.

When you position the cursor on the radar panel, the cursor position window is activated and the cursor menu options are displayed.

To remove the cursor and cursor elements from the panel, select **Clear cursor** or press the **X** key.

GoTo cursor

You can navigate to a selected position on the image by positioning the cursor on the panel, then using the **Goto Cursor** option in the menu.

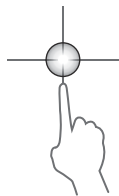

The cursor assist function

The cursor assist function allows for fine tuning and precision placement of the cursor without covering details with your finger.

Activate the cursor on the panel, then press and hold your finger on the screen to switch the cursor symbol to a selection circle, appearing above your finger.

Without removing your finger from the screen, drag the selection circle to the desired position.

When you remove your finger from the screen the cursor reverts to normal cursor operation.

Saving waypoints

You can save a waypoint at a selected location by positioning the cursor on the panel, and then selecting the new waypoint option in the menu.

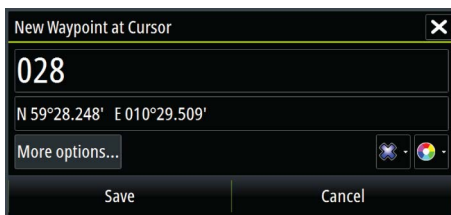

In the Chart and Nav panels, you can save a waypoint at the vessel position, when the cursor is not active, by selecting the new waypoint option in the menu.

Adjusting the radar image

You may be able to improve the radar image by adjusting the radar sensitivity, and by filtering out the random echoes from sea and weather conditions.

You can also adjust the image settings from the radar menu.

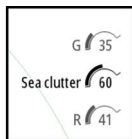

Directional clutter rejection

(Broadband 4G Radar only)

This mode automatically works when GAIN = AUTO and SEA = HARBOR or OFFSHORE. The purpose is to allow smaller vessels to be

seen in the leeward direction of the sea clutter. The GAIN of the radar receiver is increased dynamically during the sweep, in the leeward direction, for increased target sensitivity in heavier sea states.

When GAIN or SEA = MANUAL, the Directional Clutter Rejection mode will be OFF (non-directional).

In addition, CALM, MODERATE or ROUGH STC Curve settings are available in the Radar options menu to better optimize the radar image to your liking.

Gain

The gain controls the sensitivity of the radar receiver.

A higher gain makes the radar more sensitive to radar returns, allowing it to display weaker targets. If the gain is set too high, the image might be cluttered with background noise.

Gain has a manual and an automatic mode. You toggle between automatic and manual mode in the slide bar.

Sea clutter

Sea clutter is used to filter the effect of random echo returns from waves or rough water near the vessel.

When you increase Sea clutter, filtering the on-screen clutter caused by the echoes of waves is reduced.

The system includes predefined Sea clutter settings for harbor and offshore conditions, in addition to the manual mode where you can adjust the settings. You select Sea clutter modes from the menu. You can only adjust the Sea clutter value in manual mode.

Rain clutter

Rain clutter is used to reduce the effect of rain, snow or other weather conditions on the radar image.

The value should not be increased too much as this may filter out real targets.

Advanced radar options

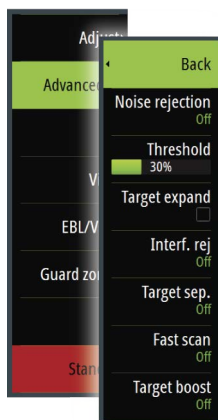

Noise Rejection

(Broadband 4G radar only)

The Noise Rejection control sets the amount of noise filtering applied by the radar. Target sensitivity is increased at longer ranges when this control is set to Low or High, but does cause some loss of target discrimination.

Tip: To get maximum range performance from Broadband 4G Radar, transmit on one range only, set the Noise Reject control to High and the threshold as low as possible. The default is 30% for less clutter on the screen. If OFF is selected for the Vulcan Series, the range performance is about equal to 3G radar. In some areas where extreme high interference may exist, try OFF for best radar image.

Radar threshold

The threshold sets required signal strength for the lowest radar signals. Radar returns below this limit are filtered and are not displayed.

Default value: 30%.

Target expansion

Target expansion increases the length of targets in range, making them easier to see.

Rejecting radar interference

Interference could be caused by radar signals from other radar units operating in the same frequency band.

A high setting reduces the interference from other radars.

In order not to miss weak targets, the interference rejection should be set to low when no interference exists.

Target separation

(Broadband 4G Radar only)

The **Target separation** control allows you to control the target discrimination of the radar (separation between objects is more prominent).

Fast scan

(Broadband and Halo radar only).

Sets the speed of the radar antenna rotation. This option gives faster target updates.

→ **Note:** Maximum speed may not be achieved depending on the radar Settings, Mode, and Range selected. The radar will only rotate as fast as the current control settings allow.

Sea State

Set the Sea State control according to current sea conditions for best sea clutter rejection.

Target boost

(3G and 4G Broadband, and Pulse Radar only)

The target boost control increases pulse length or reduces radar bandwidth to make targets appear larger in range and increase radar sensitivity.

Radar view options

View menu options vary depending on your radar antenna.



VelocityTrack

This option is available for radar antennas that have Doppler coloring functionality.

This is an unlock feature, refer to "*Feature unlock*" on page 16.

→ **Note:** When VelocityTrack is enabled antenna rotation speed may be reduced.

Doppler coloring is a navigation aid to distinguish moving targets approaching or diverging from your vessel. The radar indicates if a target is approaching or diverging from your vessel when both these conditions are true:

- The target's relative speed is greater than the VelocityTrack speed threshold.
- The target is not geo-stationary (e.g. land or a marker buoy).

The following options are available:

- Off - turns off Doppler coloring
- Normal - approaching targets and diverging targets are colored.
- Approaching targets - only approaching targets are colored

The color of approaching and diverging targets depends on the palette used:

Radar image palettes

- Diverging targets are blue colored on all radar image palettes.
- Approaching target colors on radar image palettes:
 - Black/Red palette - Yellow
 - White/Red palette - Yellow
 - Black/Green palette - Red
 - Black/Yellow palette - Red

Radar overlay palettes on charts

- Diverging targets are dark grey.
- Approaching targets are yellow.

VelocityTrack settings

Use this dialog to set speed thresholds of targets to be colored.

The speed threshold can be defined to apply for the radar source of the selected radar panel only, or to all radar sources connected to the system. The setting is only applied to those radars powered and connected at the time the setting is made. If the all radar sources option is selected, newly connected radars will use the specified values automatically.

VelocityTrack examples

Approaching and diverging moving targets can be indicated as neutral (not colored) in some circumstances. The navigator should be aware of these situations to safely use the VelocityTrack feature as an aid for collision avoidance.

Examples of how VelocityTrack behaves in 2 navigation scenarios is illustrated below. The illustrations show a target (**A**) crossing own vessel's (**B**) path.

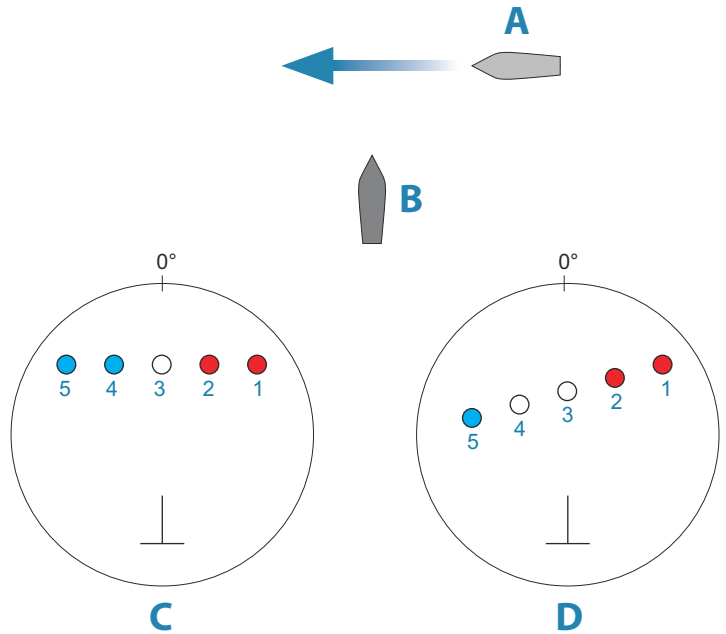

The examples show the target movement (1-5) over 5 radar scans with the radar in relative motion mode.

In example **C**, own vessel COG is 0°, and speed is 0 knots.

In example **D**, own vessel COG is 0°, and speed is 10 knots.

In both examples, the target COG is 270°, and the speed is 20 knots.

The colors in the example are according to the colors used for black/green and black/yellow radar palettes:

- Red, indicating the target is on an approaching path to own vessel. It's relative speed at that point is greater than the VelocityTrack speed threshold.
- Not colored, indicating it is temporarily neutral because it's relative speed at that point is less than the VelocityTrack speed threshold.
- Blue, indicating the target is diverging away from own vessel and it's relative speed at that point is greater than the VelocityTrack speed threshold.

Radar symbology

Radar symbology defined in the Radar Settings panel can be turned on/off collectively. See the radar panel illustration showing optional radar items.

Target trails

You can set how long the trails generated from each target on your radar panel remain. You can also turn OFF target trails.

→ **Note:** True motion is recommended when using Target trails

Clearing target trails from the panel

When target trails are displayed on the panel, the radar menu expands to include an option where you can clear target trails from your radar panel temporarily. The target trails start to appear again unless you switch them off as described above.

The radar palette

Different colors (palettes) can be used to represent detail on your radar panel.

Radar orientation

Radar orientation is indicated on the upper left corner of the radar panel as either HU (Heading UP), NU (North Up) or CU (Course up).

Head-up

In Head-up mode the heading line on the PPI is oriented on the 0° on the bearing scale and towards the top of the screen. The radar image is displayed relative to own ship, and when the ship turns the radar image rotates.

→ **Note:** Head-up is only available in Relative motion mode, and it is the only orientation mode available if the radar is not connected to a heading source.

North up

In North up mode the 0° indication on the PPI represents north. The heading line on the PPI is oriented according to own ship heading obtained from the gyro compass. When the ship turns the heading line changes its direction according to the ship's heading, while the radar image remains stabilized.

The North up orientation is not available if no heading source is connected to the radar. If heading data is lost, the system will automatically switch to Head-up orientation.

Course up

In Course up mode, the top of the bearing scale indicates the ship's true course measured from north at the time Course up was activated. When the ship turns the bearing scale remains fixed, while the heading line rotates with the ship's yawing and course change.

The Course up orientation is reset by re-selecting the Course up mode.

Radar motion mode

Radar motion is indicated on the upper left corner of the radar panel as either TM (True motion) or RM (Relative motion).

Relative motion

In Relative motion your vessel remains in a fixed location on the Radar PPI, and all other objects move relative to your position.

You select the position of the fixed location as described in *"Offsetting the PPI center"* on page 126.

True motion

In True motion your vessel and all moving targets move across the Radar PPI as you travel. All stationary objects remain in a fixed position. When the vessel's symbol reaches 75% of the PPI radius (**A**), the radar image is redrawn with the vessel symbol re-positioned (**B**) 180° opposite the current heading bearing.

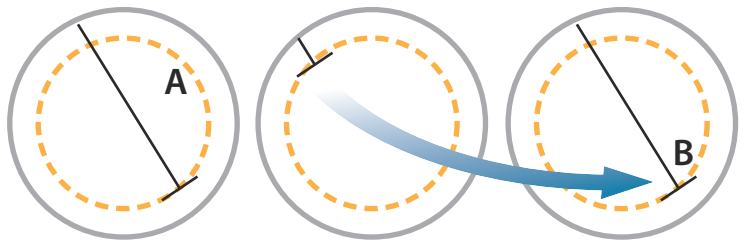

When True motion is selected, the True motion reset option is available from the menu. This allows for manually resetting the radar image and vessel symbol to its starting position.

→ **Note:** True motion is only available when the PPI is in either North Up or Course Up orientation mode.

Offsetting the PPI center

You can set the antenna position origin to different location on the radar PPI. The options described in the next sections are available.

→ **Note:** Offsetting the PPI center is allowed only in Relative motion.

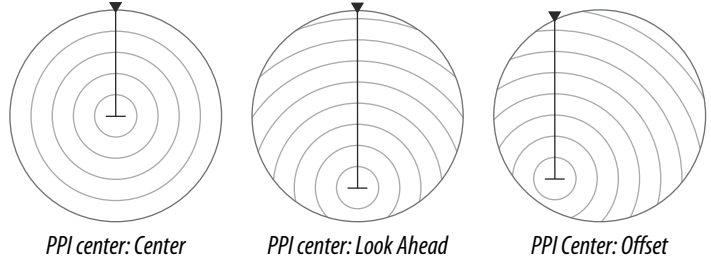

You return the antenna center to PPI center by using the offset option in the View menu.

→ **Note:** The bearing scale is according to the Consistent Common Reference Point (CCRP), while the offset sets the radar antenna position on the PPI. The maximum off-centering allowed is 75% of the radius at the current range. This may result in the CCRP being outside of the bearing scale. In such cases the measurements are still taken by the CCRP and the bearing scale is compressed accordingly.

Center

The Center option resets the antenna position to the center of the PPI.

Look ahead

The Look ahead option is used to maximize the view ahead of the vessel. When selected the PPI center is placed at 70% of the radius of the PPI, 180° opposite the top of the display.

→ **Note:** Look ahead is only available for Heading Up radar orientation.

Offset to cursor position

This option allows you to use the cursor for selecting the antenna center. When the option is selected the PPI center is immediately moved to the cursor position.

EBL/VRM markers

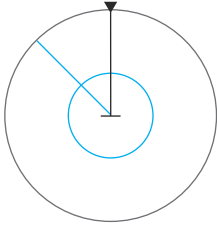

The electronic bearing line (EBL) and variable range marker (VRM) allows quick measurements of range and bearing to vessels and landmasses within radar range. Two different EBL/VRMs can be placed on the radar image.

The EBL/VRMs are by default positioned from the center of the vessel. It is, however, possible to offset the reference point to any selected position on the radar image.

When positioned, you can turn the EBL/VRM on/off by selecting the relevant markers on the data bar, or by deselecting the marker from the menu.

Defining an EBL/VRM marker

1. Ensure that the cursor is not active
2. Activate the menu, select **EBL/VRM**, then select **EBL/VRM 1** or **EBL/VRM 2**
 - The EBL/VRM is now positioned on the radar image
3. Select the adjustment option from the menu if you need to reposition the marker, then adjust the marker by dragging it into position on the radar image
4. Select the save option to save your settings

Placing EBL/VRM markers by using the cursor

1. Position the cursor on the radar image
2. Activate the menu
3. Select one of the EBL/VRM markers
 - The EBL line and the VRM circle are positioned according to the cursor position.

Offsetting an EBL/VRM marker

1. Ensure that the cursor is not active
2. Activate the menu, select **EBL/VRM**, then select the marker you wish to offset
3. Select the set offset option

4. Position the cursor on the radar panel to set the offset position
5. Select the save option to save your settings.

You can reset the EBL/VRM center to vessel position from the menu.

Setting a guard zone around your vessel

A guard zone is an area (either circular or a sector) that you can define on the radar image. When activated, an alarm alerts you when a radar target enters or exits the zone.

Defining a guard zone

1. Ensure that the cursor is not active
2. Activate the menu, select **Guard zones**, then select one of the guard zones
3. Select the shape for the zone
 - The adjustment options depend on the guard zone shape
4. Select **Adjust** to define the settings for the guard zone. The values can be set from the menu or by dragging on the radar panel.
 - **A**: Bearing, relative to the vessel heading
 - **B**: Depth
 - **C**: Range, relative to vessel center
 - **D**: Width
5. Select the save option to save your settings.

When positioned, you can turn the guard zones on/off by selecting the relevant section on the data bar.

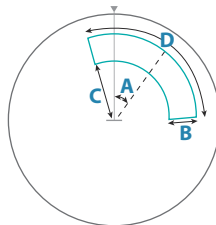

Shape: Sector

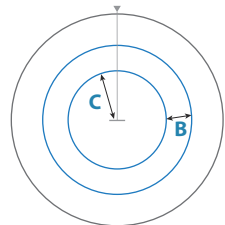

Shape: Circle

Alarm settings

An alarm is activated when a radar target breaches the guard zone limits. You can select if the alarm is activated when the target enters or exits the zone.

Sensitivity

The guard zone sensitivity can be adjusted to eliminate alarms for small targets.

MARPA targets

If the system includes a heading sensor, the MARPA function (Mini Automatic Radar Plotting Aid) can be used to track up to ten radar targets.







You can set alarms to notify you if a target gets too close. Refer to *"Radar settings"* on page 131.

MARPA tracking is an important tool for collision avoidance.

→ **Note:** MARPA requires heading data for both the radar and the Vulcan Series.

MARPA target symbols

The system uses the target symbols shown below.

	Acquiring MARPA target. Typically it takes up to 10 full rotations of the scanner.
	Tracking MARPA target, not moving or at anchor.
	Tracking and safe MARPA target with extension lines.
	Dangerous MARPA target. A target is defined as dangerous when it enters the guard zone defined on the radar panel.
	When no signals have been received within a time limit a target will be defined as lost. The target symbol represents the last valid position of the target before the reception of data was lost.
	Selected MARPA target, activated by positioning the cursor on the target icon. The target returns to the default target symbol when the cursor is removed.

Tracking MARPA targets

1. Position the cursor on the target on the radar image
2. Select **Acquire targets** from the menu
3. Repeat the process if you want to track more targets

After your targets are identified, it may take up to 10 radar sweeps to acquire and then track the target.

Cancelling MARPA target tracking

When targets are being tracked, the radar menu expands to include options for cancelling individual targets or to stop the tracking function.

Cancel tracking individual targets by selecting the target icon before activating the menu.

Viewing MARPA target information

If the pop-up is activated, you can select a MARPA target to display basic target information. Information for the 3 MARPA targets closest to the vessel is also displayed in the data bar.

When a target is selected, detailed information for the target can be displayed from the menu.

You can display information about all MARPA targets by using the **Vessels** option on the Home page.

MARPA alarm settings

You can define the following MARPA alarms:

- **MARPA target lost**
Controls whether an alarm is activated when a MARPA target is lost.
- **MARPA unavailable**
Controls whether an alarm is activated if you do not have the required inputs for MARPA to work (valid GPS position and heading sensor connected to the radar server).

Recording radar data

You can record radar data and save the file internally in the Vulcan Series unit, or save it onto a memory card inserted into the unit's card reader.

A recorded radar file can be used for documenting an event or an operational error. A logged radar file can also be used by the simulator.

If more than one radar is available, you can select which source you want to record.

Radar settings

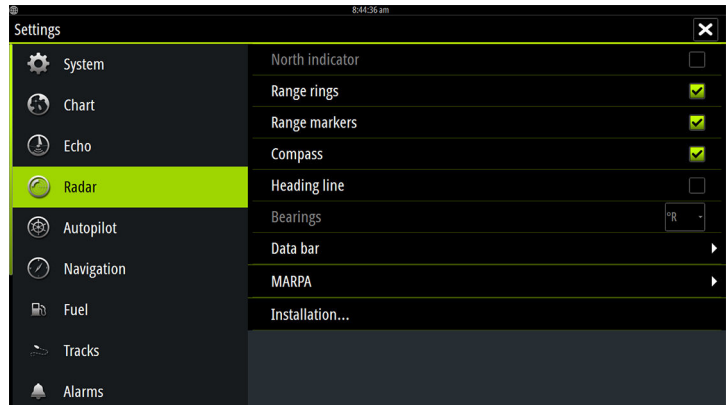
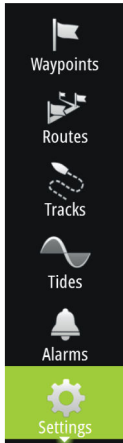

Radar symbology

You can select which optional radar items that should be turned on/off collectively from the menu. Refer to the Radar panel illustration.

Bearings

Used for selecting whether the radar bearing should be measured in relation to True/Magnetic North ($^{\circ}T/^{\circ}M$) or to your relative heading ($^{\circ}R$).

Data bar

Turns on/off the radar data bar. Refer to the radar panel illustration.

The data bar can show up to 3 targets, arranged with the most dangerous targets on top. You can select to show MARPA targets on top and before any AIS targets, even if the AIS targets are closer to your vessel.

MARPA settings

You can define the length of the MARPA trail making it easier to follow target movement.

A circle can be added around your vessel to present the danger zone. The radius of the ring is the same as the closest point of approach as set in the Dangerous Vessels dialog. Refer to "*Defining dangerous vessels*" on page 175. An alarm triggers if a vessel is tracking into your safe zone.

Installation

The Installation option is used for radar installation, described in the separate Radar or Vulcan Series Installation manuals.

13

Echosounder

The Echosounder function provides a view of the water and bottom beneath your vessel, allowing you to detect fish and examine the structure of the sea floor.

The Echosounder image

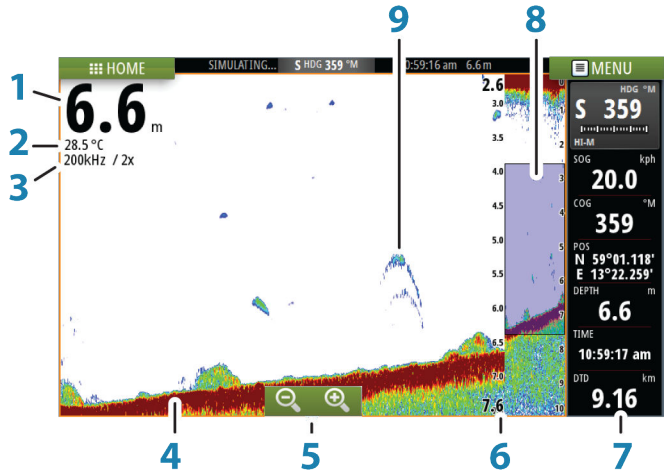

- 1 Depth
- 2 Temperature
- 3 Frequency and Zoom scale
- 4 Bottom
- 5 Zoom buttons
- 6 Depth range scale
- 7 Instrument panel
- 8 Zoom column
- 9 Fish arches

Zooming the image

You can zoom the image by:

- using the zoom (+ or -) buttons

Zoom level is shown on the upper left side of the image.

When zooming in, the sea floor is kept near the bottom of the screen, irrespective of whether it is in auto-range or manual range.

If the range is set considerably less than the actual depth, the unit is not able to find the bottom when zooming.

If the cursor is active, the unit zooms in where the cursor is pointed.

Zoom bar

The zoom bar is displayed when you zoom the image.

Drag the zoom bar vertically to view different parts of the water column.

Using the cursor on the image

The cursor can be used to measure a distance to a target, to mark a position, and to select targets.

By default, the cursor is not shown on the image.

When you position the cursor on the image; the screen pauses, the depth at the cursor position is shown, and the information window is activated.

To remove the cursor and cursor elements from the panel, select the **Clear cursor** menu option.

GoTo cursor

You can navigate to a selected position on the image by positioning the cursor on the panel, then using the **Goto Cursor** option in the menu.

The cursor assist function

The cursor assist function allows for fine tuning and precision placement of the cursor without covering details with your finger.

Activate the cursor on the panel, then press and hold your finger on the screen to switch the cursor symbol to a selection circle, appearing above your finger.

Without removing your finger from the screen, drag the selection circle to the desired position.

When you remove your finger from the screen the cursor reverts to normal cursor operation.

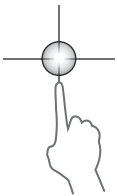

Measuring distance

The cursor can be used to measure the distance between the position of two observations on the image.

1. Position the cursor on the point from where you want to measure the distance
2. Start the measuring function from the menu
3. Position the cursor on the second measuring point
 - A line is drawn between the measuring points, and the distance is listed in the Cursor Information panel
4. Continue selecting new measuring points if required

You can use the menu to re-position the start point and the end point as long as the measuring function is active.

When you select **Finish measuring**, the image resumes to normal scrolling.

Saving waypoints

You can save a waypoint at a selected location by positioning the cursor on the panel, and then selecting the new waypoint option in the menu.

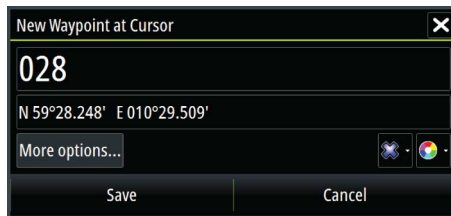

Viewing history

You can view echosounder history by panning the image.

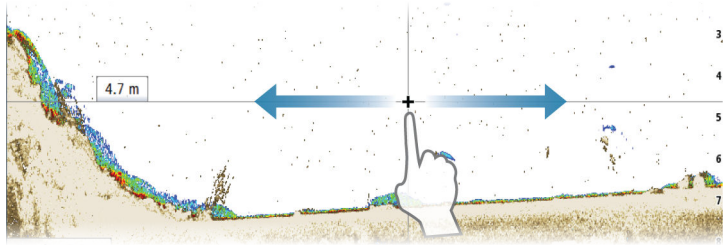

Setting up the image

Use the Echosounder menu options to set up the image. When the cursor is active, some options on the Echosounder menu are replaced with cursor mode features. Select **Clear cursor** to return to the normal Echosounder menu.

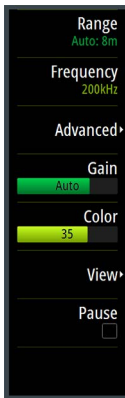

The range

The range setting determines the water depth that is visible on the screen.

Frequency

The unit supports several transducer frequencies. Available frequencies depend on the transducer model that is connected.

You can view two frequencies at the same time by selecting dual Echosounder panels from the **Home** page.

Frequency is the 'tone' the transducer transmits. Transducers are designed to operate on different frequencies as the various frequencies have different qualities.

- A low frequency, for example 50 kHz, will go deep. It generates a wide cone but is somewhat more sensitive to noise. It is good for bottom discrimination and wide area search.
- A high frequency, for example 200 kHz, offers higher discrimination and is less sensitive to noise. It is good for separating targets and for higher speed vessels.

Gain

The gain controls the sensitivity. The more you increase the gain, the more details are shown on the image. However, a higher gain

setting may introduce more background clutter on the image. If the gain is set too low, weak echoes might not be displayed.

Auto gain

The Auto gain option keeps the sensitivity at a level that works well under most conditions. With the gain in auto mode, you can set a positive or negative offset that gets applied to the auto gain.

Color

Strong and weak signals have different colors to indicate the different signal strengths. The colors used depend on which palette you select. The more you increase the Color setting, the more echoes are displayed in the color at the strong return end of the scale.

DownScan options

Provides options for specifying the DownScan image. This menu option is available when Overlay downscan is selected in Echo settings dialog. For more information see "*Echosounder settings*" on page 143.

Pausing the image

You can pause the image, allowing you to examine it.

This function is useful when you need to position a waypoint exactly on the image, and if you are using the cursor to measure a distance between 2 elements on the image.

The pause function stops the Echosounder from pinging the transducer. The system is not collecting Echosounder data when paused in this manner.

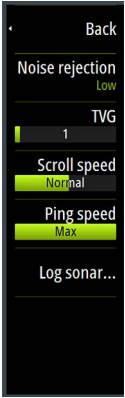

Advanced options

The Advanced option is only available when the cursor is not active.

Noise rejection

Signal interference from bilge pumps, engine vibration and air bubbles can clutter the image.

The noise rejection option filters the signal interference and reduces the on-screen clutter.

TVG

Wave action and boat wakes can cause onscreen clutter near the surface. The TVG (Time Variable Gain) option reduces surface clutter by decreasing the sensitivity of the receiver near the surface.

→ **Note:** For optimal image return and clarity in most conditions, the default value is set to 3, the maximum (range is 0-3).

Scroll speed

You can select the scrolling speed of the image on the screen. A high scroll speed updates the image fast, while a low scroll speed presents a longer history.

→ **Note:** In certain conditions it may be necessary to adjust the scroll speed to get a more useful image. Such as adjusting the image to a faster speed when vertically fishing without moving.

Ping speed

Ping speed controls the rate the transducer transmits the signal into the water. By default, the ping speed is set to max. It may be necessary to adjust the ping speed to limit interference or to adjust for specific fishing conditions.

Start recording log data

You can start recording log data and save the file internally in the unit, or save it onto a card inserted into the unit's card reader.

The record function is activated from the **Advanced** menu option.

When the data is being recorded, there is a flashing red symbol in the top left corner and a message appears periodically at the bottom of the screen.

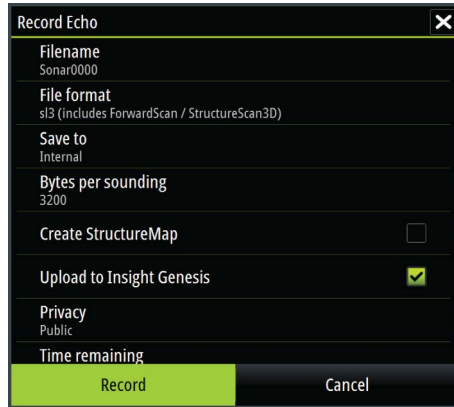

Filename

Specify the name of the recording (log).

File format

Select a file format from the drop-down, slg (Echosounder only), xtf (Structure only*), sl2 (Echosounder and Structure) or sl3 (includes StructureScan 3D).

→ **Note:** XTF format is for use only with select 3rd party Echosounder viewing tools.

Save to

Select whether the recording is to be saved internally or to a memory card in the card reader.

Bytes per sounding

Select how many bytes per seconds that are to be used when saving the log file. More bytes yield better resolution, but cause the record file to increase in size compared to using lower byte settings.

Create StructureMap

If a StructureScan transducer is connected to the unit, you can convert the .sl2 or .sl3 logs to StructureMap format (.smf) when recording completes. The log file can also be converted to StructureMap format from the Files option.

Upload to Insight Genesis

Files are transmitted to Insight Genesis when recording completes, if you are connected to a wireless hotspot. For information about wireless hotspots, refer to "*Wireless connection*" on page 162.

Privacy

If allowed by your selected Insight Genesis account, you can choose between setting the recorded log files as Private or Public at Insight Genesis.

Time remaining

Shows the remaining allocated space available for recordings.

Stop recording log data

Select **Stop** in the Recording Echo dialog to fully stop the recording of all echosounder data.

→ **Note:** If you have selected the **Upload to Insight Genesis** option and are connected to a wireless hotspot, your recorded files are transmitted to Insight Genesis when you select **Stop**.

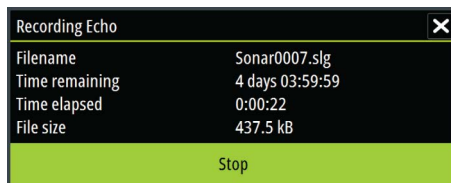

Viewing the recorded sounder data

Both internally and externally stored sounder records may be reviewed when the view sonar log option is selected in the Echo settings dialog. Refer to "*Echosounder settings*" on page 143.

The log file is displayed as a paused image, and you control the scrolling and display from the replay menu option.

You can use the cursor on the replay image, and pan the image as on a normal echo image.

If more than one channel was recorded in the selected echo file, you can select which channel to display.

You exit the replay mode by selecting the **X** symbol in the upper right corner of the replay image.

Echosounder View options

Split screen options

Zoom

The Zoom mode presents a magnified view of the sounder image on the left side of the panel.

By default the zoom level is set to 2x. You can select up to 8x zoom from the drop-down menu or the zoom (+ or -) buttons.

The range zoom bars on the right side of the display shows the range that is magnified. If you increase the zooming factor the range is reduced. You see this as reduced distance between the zoom bars.

Bottom lock

The bottom lock mode is useful when you want to view echoes close to the bottom. In this mode, the left side of the panel shows an image where the bottom is flattened. The range scale is changed to measure from the seabed (0) and upwards. The bottom and the zero line are always shown on the left image, independent of the range scale. The scaling factor for the image on the left side of the panel is adjusted as described for the Zoom option.

Palettes

You can select between several display palettes optimized for a variety of fishing conditions.

Temperature graph

The temperature graph is used to illustrate changes in water temperature.

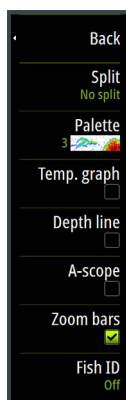

When toggled on, a colored line and temperature digits are shown on the Echosounder image.

Depth line

A depth line can be added to the bottom surface to make it easier to distinguish the bottom from fish and structures.

A-Scope

The A-scope is a display of real-time echoes as they appear on the panel. The strength of the actual echo is indicated by both width and color intensity.

Zoom bars

The zoom bars shows the range that is magnified on a split panel with zoom views.

The range zoom bars on the right side of the display shows the range that is magnified and displayed on the left side. If you increase the zooming factor, the range is reduced. You see this as reduced distance between the zoom bars.

You can move the zoom bars on the right side up or down to cause the left side image to show different depths of the water column.

Fish ID

You can select how you want the echoes to appear on the screen. You can also select if you want to be notified by a beep when a fish ID appears on the panel.

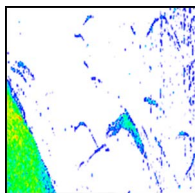

Traditional fish echoes

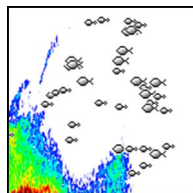

Fish symbols

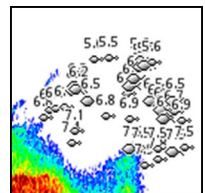

Fish symbols and depth indication

→ **Note:** Not all fish symbols are actual fish.

Echosounder settings

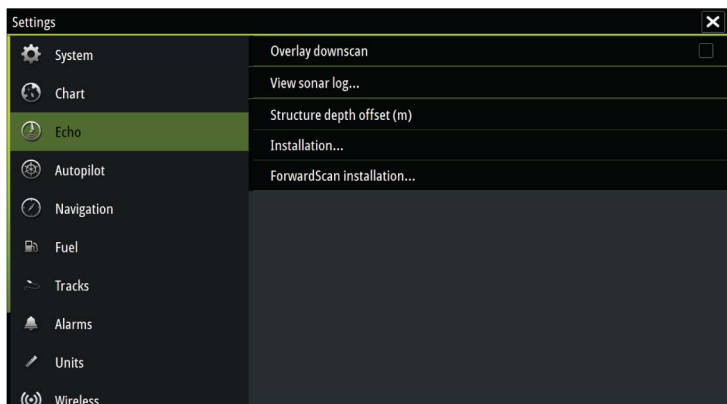
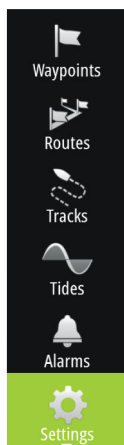

Overlay downscan

When a HDI transducer with DownScan is connected to your system, you can overlay DownScan images on the regular Echosounder image.

When activated, the Echosounder menu expands to include basic DownScan options.

View Echosounder log

Used to view Echosounder recordings. The log file is displayed as a paused image, and you control the scrolling and display from the menu.

You can use the cursor on the image, measure distance, and set view options as on a live Echosounder image. If more than one channel was recorded in the selected Echosounder file, you can select which channel to display.

You exit the view function by selecting the **X** in the upper right corner.

Structure depth offset

Setting for Structure transducers.

All transducers measure water depth from the transducer to the bottom. As a result, water depth readings do not account for the distance from the transducer to the lowest point of the boat in the water or from the transducer to the water surface.

To show the depth from the lowest point of the boat to the bottom, do the following. Before setting the Structure offset, measure the distance from the structure transducer to the lowest point of the boat in the water. If, for example, the distance is 0.3 m (1 ft), it will be input as (minus) - 0.3 m (-1 ft).

To show the depth from the water surface to the bottom, do the following. Before setting the Structure offset, measure the distance from the structure transducer to the water surface. If, for example, the distance is 0.3 m (1 ft), it will be input as (plus) 0.3 m (1 ft).

A setting of 0 (zero) causes the depth displayed to be the distance from the transducer to the bottom.

Installation

Used for installation and setup. See the separate Vulcan Series Installation manual

ForwardScan Installation

Used for ForwardScan installation and setup. Refer to the "*ForwardScan setup*" on page 159.

14

StructureScan

StructureScan uses high frequencies to provide a high resolution, picture-like image of the seabed.

→ **Note:** You must have a StructureScan HD or TotalScan transducer installed to use StructureScan features.

StructureScan provides a wide coverage in high detail with SideScan, while DownScan provides detailed images of structure and fish directly below your boat. The StructureScan page is accessed from the **Home** page when the transducer is connected.

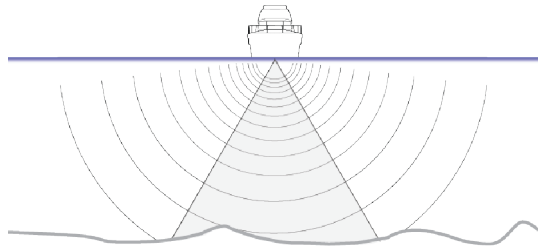

The StructureScan image

The view

The StructureScan panel can be set up as a DownScan image, or showing left/right side scanning.

The DownScan image can also be added as an overlay to the traditional Echosounder image.

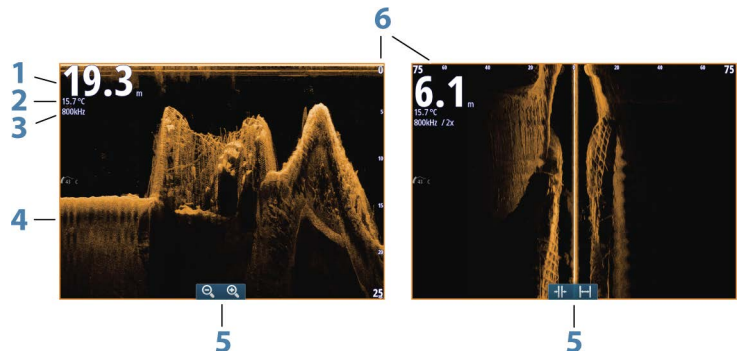

- 1 Depth
 - **Note:** The depth reading depends on the **Structure depth offset** setting, refer to "*Structure depth offset*" on page 143
- 2 Temperature
- 3 Frequency
- 4 Bottom
- 5 Zoom (downscan) / Range (sidescan) icons
- 6 Range scale

Zooming the StructureScan image

You can zoom a StructureScan image by:

- using the panel zoom icons
- by pinching or spreading on the screen

Using the cursor on the StructureScan panel

By default, the cursor is not shown on the StructureScan image.

When you position the cursor on a DownScan image, the screen pauses, the cursor information window and the history bar are activated. On a DownScan image, the depth is shown at cursor position.

When you position the cursor on a SideScan image, the screen pauses, and the cursor information window is activated. On a SideScan image, the left/right distance from the vessel to the cursor are shown at the cursor position.

GoTo cursor

You can navigate to a selected position on the image by positioning the cursor on the panel, then using the **GoTo Cursor** option in the menu.

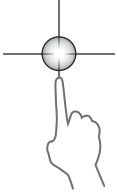

The cursor assist function

The cursor assist function allows for fine tuning and precision placement of the cursor without covering details with your finger.

Activate the cursor on the panel, then press and hold your finger on the screen to switch the cursor symbol to a selection circle, appearing above your finger.

Without removing your finger from the screen, drag the selection circle to the desired position.

When you remove your finger from the screen the cursor reverts to normal cursor operation.

Measuring distance

The cursor can be used to measure the distance between the position of two observations on the image.

1. Position the cursor on the point from where you want to measure the distance
2. Start the measuring function from the menu
3. Position the cursor on the second measuring point
 - A line is drawn between the measuring points, and the distance is listed in the Cursor Information panel
4. Continue selecting new measuring points if required

You can use the menu to re-position the start point and the end point as long as the measuring function is active.

When you select **Finish measuring**, the image resumes to normal scrolling.

Saving waypoints

You can save a waypoint at a selected location by positioning the cursor on the panel, and then selecting the new waypoint option in the menu.

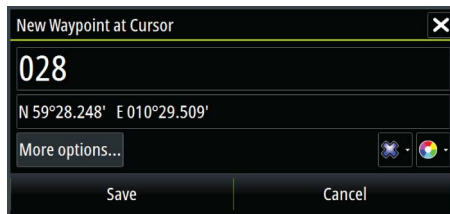

Viewing StructureScan history

Whenever the cursor is active on a StructureScan panel, the scroll bar is shown on the panel. The scroll bar shows the image you are currently viewing in relation to the total StructureScan image history stored. Depending on the view selected, the scroll bar is on the far right side (SideScan) or at the top of the screen (DownScan).

You can pan the image history by dragging up/down (SideScan) or left/right (DownScan).

To resume normal StructureScan scrolling, press **Clear cursor**.

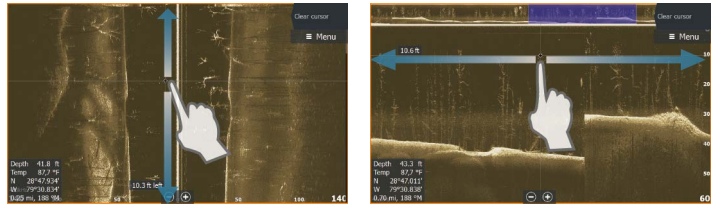

Setting up the StructureScan image

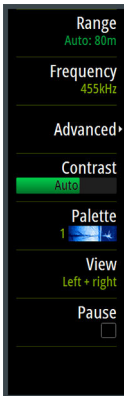

Range

The range setting determines the water depth and SideScan range that is visible on the screen.

Auto range

When the range is set to Auto the system automatically sets the range depending on the water depth.

Preset range levels

You can select between several preset range levels.

StructureScan frequencies

StructureScan supports two frequencies. 455 kHz provides ideal range and image quality in most situations, while 800kHz is used to provide higher detail in shallow water.

Contrast

Determines the brightness ratio between light and dark areas of the screen.

To adjust the contrast setting:

1. Select the contrast icon or activate the contrast option in the menu to display the color adjustment bar
2. Drag the bar up or down to get the desired contrast setting or select **Auto contrast**.

→ **Note:** We recommend that you use **Auto contrast**.

Palettes

You can select between several display palettes optimized for a variety of fishing conditions.

View

You can set up the StructureScan page as a DownScan image, left only, right only, or left/right side scanning.

Select the view menu option and then the view you want displayed.

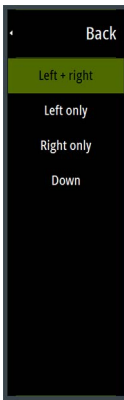

Pausing the StructureScan image

You can pause the StructureScan image, allowing you to examine the structures and other images in more depth and detail.

This function is useful when you need to position a waypoint exactly on the StructureScan image, and if you are using the cursor to measure a distance between 2 elements on the image.

Advanced StructureScan settings

TVG

Wave action and boat wakes can cause onscreen clutter near the surface. The TVG (Time Variable Gain) option reduces surface clutter by decreasing the sensitivity of the receiver near the surface.

→ **Note:** For optimal image return and clarity in most conditions, the default value is set to 3, the maximum (range is 0-3).

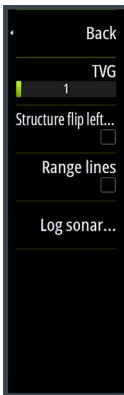

Flipping the Structure image left/right

If required, the left/right SideScanning images can be flipped to match the direction of the transducer installation.

Range Lines

Range lines can be added to the image to make it easier to estimate depth (Downscan) and distance (SideScan).

Recording StructureScan data

You can record StructureScan data and save the file internally in the Vulcan Series unit, or onto memory card as described in "*Start Recording echosounder data*" on page 138.

15

StructureMap

The StructureMap feature overlays SideScan images from a StructureScan source on the map. This makes it easier to visualize the underwater environment in relation to your position, and aids in interpreting SideScan images.

The StructureMap image

The example below shows a chart panel with Structure overlay, combined with a traditional SideScan panel.

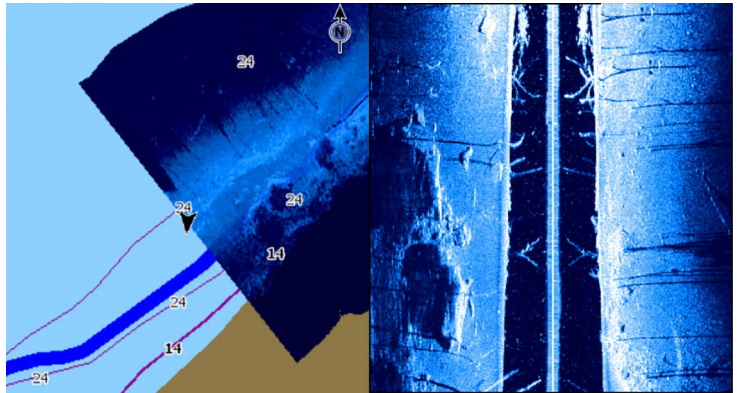

You move around in the chart as usual when you have a Structure overlay:

- Zoom the chart and the scanned image by using the zoom (+ or -) buttons. Drag on the panel to view the scanned image.

Activating Structure overlay

1. Turn on Structure overlay from the chart menu
 - The chart menu is increased to show Structure options
 - Structure data starts to appear on the chart screen as soon as Structure overlay is enabled
 2. Select Structure source
 - Live data is default
- **Note:** Structure overlay can also be activated by selecting a saved StructureMap file in the files browser.

StructureMap sources

Two sources can be used to overlay Structure logs on the charts, but only one can be viewed at a time:

- Live data - Used when StructureScan data is available on the system.
- Saved files - These are recorded StructureScan (*.sl2 or *.sl3) data that are converted to StructureMap (*.smf) format. Saved *.smf files can be used even if no StructureScan sources are connected.

Live source

When live data is selected, the SideScan imaging history is displayed as a trail behind the vessel icon. The length of this trail varies depending on available memory in the unit and range settings. As the memory fills up, the oldest data is automatically deleted as new data is added. When increasing the search range, the ping speed of the StructureScan transducer is reduced, but the width and the length of the image history is increased.

→ **Note:** Live mode does not save any data. If the unit is turned off, all recent data is lost.

Saved files

When Saved files are selected, the StructureMap file is overlaid on the map based on position information in the file.

If the chart scale is large, the StructureMap area is indicated with a boundary box until the scale is large enough to show Structure details.

Saved mode is used to review and examine StructureMap files, and to position the vessel on specific points of interest on a previous scanned area.

→ **Note:** When saved files are used as the source, all StructureMap files found on the memory card and in the system's internal memory are displayed. If there is more than one StructureMap of the same area, the images overlap and clutter the chart. If several logs of the same area are required, the maps should be put on separate memory cards.

StructureMap tips

- To get a picture of taller structures (a wreck, etc.) — do not drive over it, instead, steer the boat so the structure is on the left or right side of your vessel.
- Do not use Autorange when using StructureScan. Set your structure range to a significantly greater level (two-to-three times) than the water depth to ensure a complete scan and to maximize conversion accuracy.
- Do not overlap history trails when conducting a side-by-side scan of an area.

Recording StructureScan data

StructureScan data can be recorded from a chart panel with Structure overlay enabled.

StructureScan recordings can also be started from a StructureScan panel.

When StructureScan data is being recorded, there is a flashing red symbol and a message appears periodically at the bottom of the screen.

→ **Note:** The message includes information about file size. Keep the size of your logs to 100MB or less to allow for faster file conversion.

The recording is stopped by re-selecting the record function.

Converting StructureScan data to StructureMap format

A StructureScan log file (.sl2) is converted to StructureMap format (.smf) after recording from the recording dialog, or from the files browser.

You can create standard or high resolution files. High resolution .smf files capture more detail, but take longer to convert and are larger than standard resolution files.

To save disc space it is recommended to remove the StructureScan (.sl2) files after conversion.

Using StructureMap with mapping cards

StructureMap allows you to maintain full chart capability and can be used with embedded cartography as well as Navionics, Insight and other third-party charting cards compatible with the system.

When using StructureMap with mapping cards, copy the StructureMap (.smf) files to the unit's internal memory. We recommend keeping copies of StructureMap files on external mapping cards.

Structure options

You adjust the StructureMap settings from the Structure options menu. The menu is available when Structure overlay is enabled.

Not all options are available when saved StructureMap files are used as the source. Unavailable options are greyed.

Range

Sets the search range.

Transparency

Sets the opaqueness of the Structure overlay. With minimum transparency settings, the chart details are almost hidden by the StructureMap overlay.

Palette

Selects Structure palette.

Contrast

Determines the brightness ratio between light and dark areas of the screen.

Water column

Shows/hides the water column in Live mode.

If turned OFF schools of bait fish might not be seen on the SideScan image.

If turned ON the accuracy of the SideScan image on the map might be affected by the water depth.

Frequency

Sets the transducer frequency used by the unit. 800 kHz offers the best resolution, while 455 kHz has greater depth and range coverage.

Noise rejection

Signal interference from bilge pumps, engine vibration and air bubbles can clutter the sonar screen. The noise rejection option filters the signal interference and reduces on-screen clutter.

Clear live history

Clears existing live history data from the screen and begins showing only the most current data.

Record data

Records StructureScan data.

Source

Selects StructureMap source.

16

ForwardScan

ForwardScan sonar is a navigational aid that helps you monitor the underwater environment in front of your vessel while carrying out slow speed maneuvers.

To use the ForwardScan feature you must have a ForwardScan transducer mounted on your vessel. For installation instructions, refer to the ForwardScan transducer installation manual.

⚠ Warning: Do not rely on this equipment as your principle source of navigation or hazard detection.

⚠ Warning: Do not use this equipment to gauge depth or other conditions for swimming or diving.

The ForwardScan image

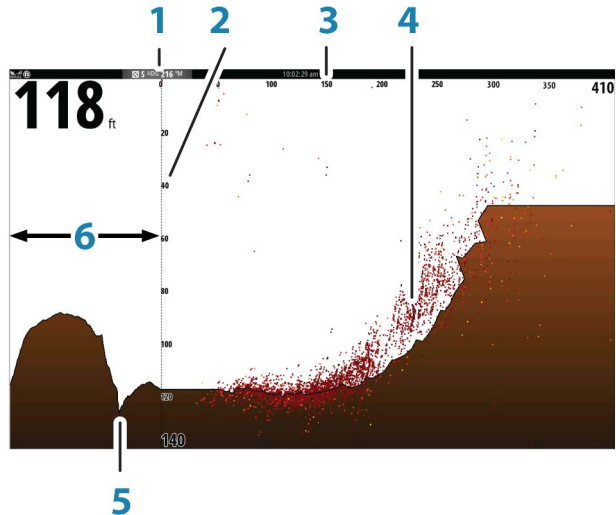

- 1 Transducer location shown as the origin on the page
- 2 Depth range scale and vessel position
- 3 Forward range scale

- 4 Point data
- 5 Bottom
- 6 Depth history

Setting up the ForwardScan image



Depth

Controls depth range. Depth range is set to auto mode by default.

Forward range

Controls the forward looking search range. Maximum Forward range is 91 meters (300 feet).

Noise Rejection

Filters out signal interference and reduces on-screen clutter.

Record

Records ForwardScan sonar logs.

Pause

Pauses forward-looking Echosounder transmissions.

ForwardScan view options

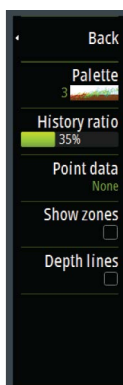

Palette

Several display palettes are available for a variety of water conditions.

History ratio

Controls how much Echosounder history is shown behind the boat. The higher the ratio, the more history will be shown.

Point data

By default, ForwardScan only shows the bottom. Select the Point data menu option to specify to view no sonar data points, all sonar data points, or only points (Objects) in the water column.

Show zones

Displays warning zones (yellow) and critical zones (red) on the screen. Refer to "*Critical forward range and Critical depth*" on page 159.

Depth lines

Displays lines on the screen that make it easier to quickly estimate depth and the underwater objects.

Heading extension

You can use the heading extension to monitor ForwardScan on the chart panel. Heading extension colors are based on the ForwardScan alarm values.

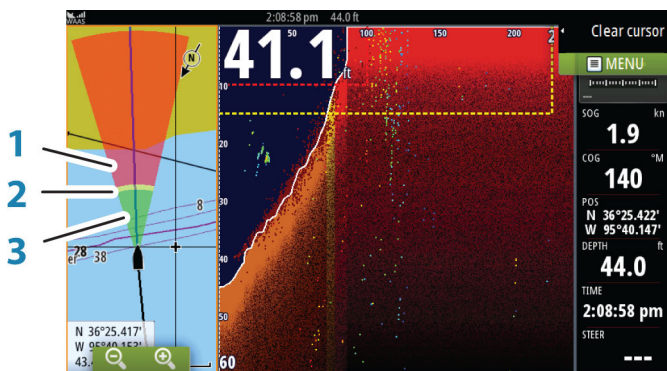

ForwardScan extension

- 1 Red - Critical
- 2 Yellow - Warning
- 3 Green - Safe

Select ForwardScan in the Chart Settings dialog to view the ForwardScan heading extension on the chart panel.

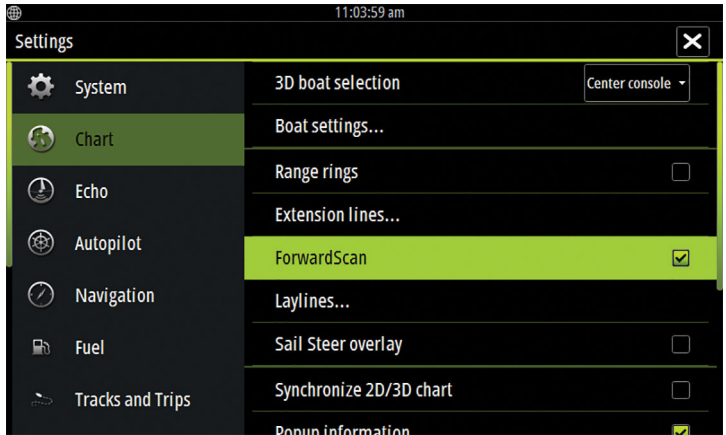

ForwardScan setup

Specify the setup in the **ForwardScan installation** dialog.

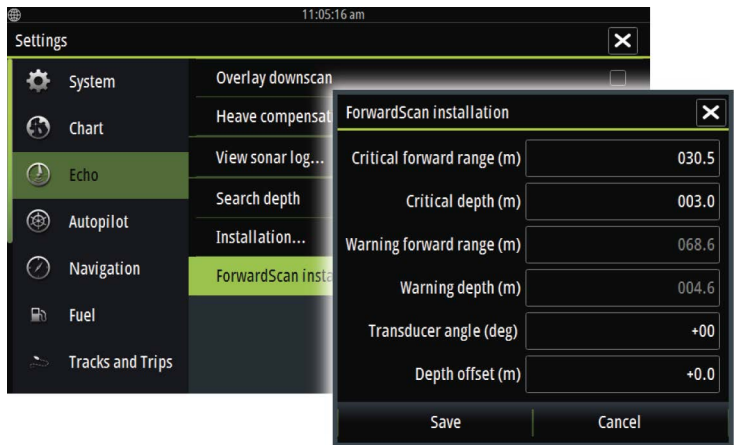

Critical forward range and Critical depth

Critical Forward Range and Critical Depth are user-selected thresholds that define a critical zone forward of your vessel.

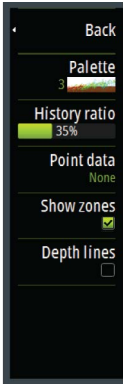

If you travel into water shallow enough to cross into the critical zone, the Critical Zone alarm is activated. You can display the critical warning zones by activating the **Show zones** menu option.

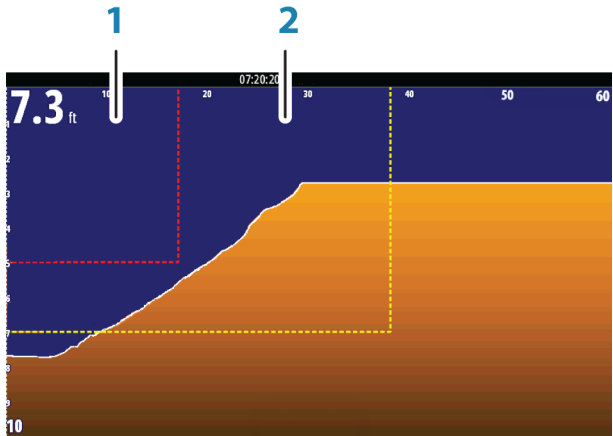

ForwardScan image with Show zones active

- 1 Critical zone
- 2 Warning zone

Warning Forward Range and Warning Depth values are based on the selected Critical Forward Range and Critical Depth values.

→ **Note:** To receive Critical Zone alerts, enable ForwardScan alarm in the Alarm settings dialog. For more information about enabling alarms, refer to Alarms.

Transducer angle

We recommend installing the transducer vertical to the waterline. In cases where that is not possible, the Transducer Angle setting helps offset the difference between the transducer angle and the waterline.

The angle can be adjusted from 0 (vertical) to 20 degrees.

⚠ Warning: Adjustments to the transducer angle value should be done with caution. Large variations in the transducer angle value can distort depth data, increasing the risk of striking underwater obstructions.

Depth offset

This is a value that can be entered on the Echo Installation page to make depth readings relate to any point from the water surface, to the deepest point of the vessel. Below are some alternative ways in which the offset can be entered:

Before setting the offset, measure the distance from the transducer to the lowest point of the boat in the water or from the transducer to the water surface.

A) For depth below keel: Set the distance from transducer to the bottom of the keel - this should be set as a negative value. For example, -2.0.

B) For depth below transducer: no offset required (the offset is set to 0).

C) For depth below surface (waterline): Set the distance from transducer to the surface - this should be set as a positive value. For example, +0.5.

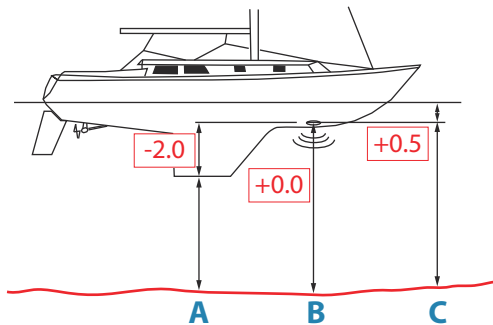

17

Wireless connection

GoFree wireless connectivity gives you the ability to:

- Use a wireless device to remotely view (smartphone and tablet) and control the system (tablet only).
- Access the GoFree Shop.
- Upload your Echosounder logs to create custom maps at Insight Genesis.
- Download software updates
- Connect to third party applications



→ **Note:** Maps, charts, software updates, and other data files can be large. Your data provider may charge you based on the amount of data you transfer. If you are unsure contact the service provider for information.

The unit includes Built-in wireless functionality for connecting to the internet and wireless devices such as smartphones and tablets.

Initial configuration and setup of the built-in wireless functionality is described in your system's Installation Manual.

→ **Note:** To use the built-in wireless, it must be enabled. Refer to "*Internal Wireless*" on page 167.

Connect and disconnect from a wireless hotspot



To connect to a wireless hotspot, select the Wireless option in the System Controls dialog and then select Not Connected. This opens the Wireless Devices dialog. Use this dialog to select the desired hotspot, enter the login information and then select Connect. Connecting to a wireless hotspot changes the wireless mode to **Client mode**. In this mode, you can access the GoFree Shop.

To disconnect from a wireless hotspot, select the Wireless option in the System Controls dialog, then select Connected *hotspot_name*, and then Disconnect. This changes the wireless mode to **Access point mode**. In this mode, you can connect a wireless device so that Apps such as GoFree Link can access the vessel's navigation information.

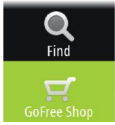

GoFree Shop

The wireless must be connected to an external wireless hotspot in order to access the GoFree Shop.

At the GoFree Shop you can browse, purchase and download compatible content for your system including navigation charts and Insight Genesis Maps. When you log on, the system automatically gives you a notification if a new software version is available for your system. If an update is available, you can download it to a card slot or defer the download until later. If you defer the download until later, the notification is available in the About dialog accessible from the System Settings.

GoFree Link



The wireless functionality lets you use a wireless device to remotely view (smartphone and tablet) and control the system (tablet only). The system is viewed and controlled from the wireless device by the GoFree Link Apps downloaded from their relevant Application store. When remote control is accepted, the active page is mirrored to the wireless device.

- **Note:** To use smartphones and tablets to view and control the system, wireless functionality must be disconnected from the wireless hotspot (in **Access point mode**).
- **Note:** For safety reasons, Autopilot and CZone functions cannot be controlled from a wireless device.

Connecting a tablet

Install the GoFree App on the tablet before following this procedure.

1. Set the internal wireless to **Access Point** mode. To do this, select the **Wireless devices** page in the Wireless settings dialog and then select the Internal wireless. Next, select the **Mode** option and then select **Internal Access Point**.
2. Select the Internal Wireless device on the **Wireless devices** page to view its Network key.
3. Navigate to the wireless network connection page on the tablet, and find the unit or GoFree wireless **xxxx** network. If more than one is in range, review the **Wireless devices** page on the unit to confirm which wireless device is connected to the unit.

4. Enter the Network Key in the tablet to connect to the network.
5. Open the GoFree application - the unit should be automatically detected. The name displayed will be either the default, or that assigned in the Device Name setting. If the unit does not appear, follow the on screen instructions to manually find the device.
6. Select the graphic icon of the unit. The unit displays a prompt similar to the following:

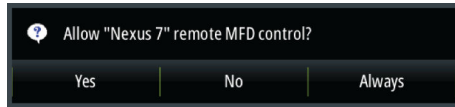

7. Select **Yes** for one-time connection, or **Always** if device is to be remembered for regular connection. This setting can be changed later if required.
- **Note:** The internal wireless module only supports GoFree connection to itself. Other units connected on the network are not visible.

Connecting a smartphone

Install the GoFree App on the smartphone before following this procedure.

1. Set the internal wireless to **Access Point** mode. To do this, select the **Wireless devices** page in the Wireless settings dialog and then select the unit's Internal Wireless. Next, select the **Mode** option and then select **Internal Access Point**.
2. Select the Internal Wireless device on the **Wireless devices** page to view its Network Key.
3. Navigate to the wireless network connection page on the smartphone, and find the unit or GoFree wireless **xxxx** network. If more than one is in range, review the **Wireless devices** page from the unit's Wireless settings dialog to confirm which wireless device is connected to the unit.
4. Enter the Network Key in the smartphone to connect to the network.
5. Open the GoFree application on the smartphone, the unit should be automatically detected. The name displayed will be either the default, or that assigned in the Device Name setting. If the unit does not appear, follow the on screen instructions to manually find the device.

The MFD's display is shown on the smartphone. To change the MFD's display on the smartphone, use the MFD to change the display on the MFD. The display change on the MFD is reflected on the smartphone.

Uploading log files to Insight Genesis

To upload a recorded Echosounder log file to Insight Genesis, select the file you want to upload from the Files panel and select the upload to Insight Genesis option.

- **Note:** You must be connected to a wireless hotspot to upload recorded log files to Insight Genesis.
- **Note:** Recorded log files can also be uploaded to Insight Genesis if you have specified **Upload to Insight Genesis** in the Record Echo dialog. For more information, refer to *"Start Recording log data"* on page 138.

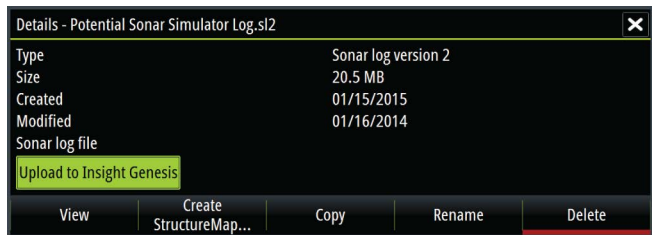

Wireless settings

Provides configuration and setup options for the wireless functionality.

For more information, refer to the Vulcan Series Installation Manual.

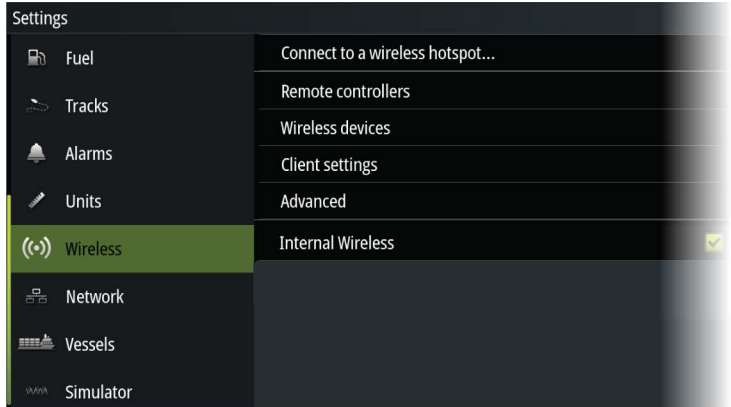

Connect to a wireless hotspot

Displays the Wireless device dialog that you can use to connect the wireless functionality to a wireless hotspot.

Remote controllers

When a wireless device (smart phone or tablet) is connected, it should appear in the Remote controllers list. Selecting **Always allow** means the device can automatically connect without needing a password each time. This menu also allows you to disconnect devices that no longer require access.

Wireless devices

This dialog shows the internal wireless and any connected WIFI-1 devices, as well as their IP and channel number. Selecting the internal wireless or a WIFI-1 device provides additional detail.

→ **Note:** WIFI-1 is available if the unit has a Radar connection on the back of the unit. The Radar connection can be used as an Ethernet connection for the WIFI-1.

To view and change internal wireless detail values (Network Name (SSID), Network Key, or Channel) the internal wireless must be in **Access Point** (Internal Wifi) mode. To select a network (hotspot) to connect to, the internal wireless must be in **Client Mode**. Use the Mode option to change modes.

Client settings

Displays information about the wireless hotspot your unit is connected to or the last one your unit was connected to. You can select the hotspot in the dialog to set it as a hotspot you want to always connect to when in range or you can select to delete it.

Advanced

Initiates the lperf and DHCP Probe tools that help in fault-finding and setting up the wireless network.

→ **Note:** lperf and DHCP Probe are tools provided for diagnostic purposes by users familiar with network terminology and configuration. Navico is not the original developer of these tools, and does not provide support related to their use.

Internal Wireless

Select this option to enable or disable the internal wireless module. Disabling wireless when not in use reduces the unit's power consumption.

18

AIS



If a compatible AIS (Automatic Identification System) source is connected to the system, then any targets detected by these devices can be displayed and tracked. You can also see messages and position for DSC transmitting devices within range.

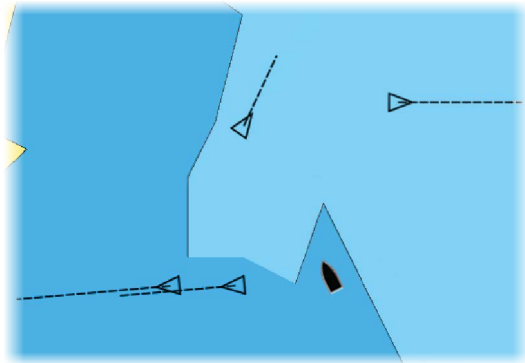

AIS targets can be displayed as overlay on chart images, making this feature an important tool for safe travelling and collision avoidance. You can set alarms to notify you if an AIS target gets too close or if the target is lost.



AIS target symbols

The system uses the AIS target symbols shown below:

	Sleeping AIS target (not moving or at anchor).
	Moving and safe AIS target with course extension line.
	Dangerous AIS target, illustrated with bold line. A target is defined as dangerous based on the CPA and TCPA settings. Refer to " <i>Defining dangerous vessels</i> " on page 175.

	<p>Lost AIS target. When no signals have been received within a time limit, a target is defined as lost. The target symbol represents the last valid position of the target before the reception of data was lost.</p>
	<p>Selected AIS target, activated by selecting a target symbol. The target returns to the default target symbol when the cursor is removed from the symbol.</p>
	<p>AIS SART (AIS Search And Rescue Transmitter).</p>

Viewing information about AIS targets

Searching for AIS items

You can search for AIS targets by using the **Find** option in the Tools panel.

From a chart panel you can search for AIS targets by using the **Find** option in the menu. If the cursor is active, the system searches for vessels around the cursor position. Without an active cursor, the system searches for vessels around your vessel's position.

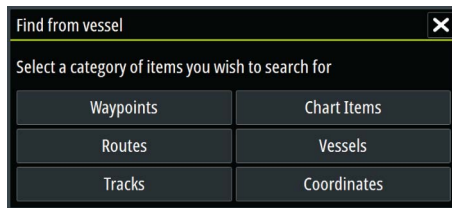

Viewing information about single AIS targets

When you select an AIS icon on the chart panel the symbol changes to Selected target symbol, and the vessel's name is displayed.

You can display detailed information for a target by selecting the AIS pop-up, or from the menu when the target is selected.

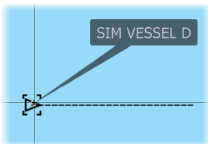



Calling an AIS vessel

If the system includes a VHF radio supporting DSC (Digital Select Calling) calls over NMEA 2000, you can initiate a DSC call to other vessels from the Vulcan Series.

The call option is available in the **AIS Vessel Details** dialog, and in the **Vessel** status dialog activated from the **Tools** panel.

From the **Call** dialog you can change channel or cancel the call. The **Call** dialog is closed when the connection is established.

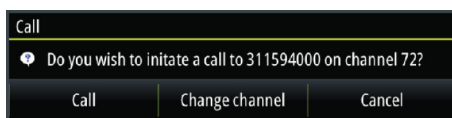

AIS SART



When an AIS SART (Search and Rescue beacon) is activated, it starts transmitting its position and identification data. This data is received by your AIS device.

If your AIS receiver is not compliant with AIS SART, it interprets the received AIS SART data as a signal from a standard AIS transmitter. An icon is positioned on the chart, but this icon is an AIS vessel icon.

If your AIS receiver is compliant with AIS SART, the following takes place when AIS SART data is received:

- An AIS SART icon is located on the chart in the position received from the AIS SART
- An alarm message is displayed

If you have enabled the siren, the alarm message is followed by an audible alarm.

→ **Note:** The icon is green if the received AIS SART data is a test and not an active message.

AIS SART alarm message

When data is received from an AIS SART, an alarm message is displayed. This message includes the AIS SART's unique MMSI number, and its position, distance, and bearing from your vessel.



You have the following options:

- Ignore the alarm
 - The alarm is muted and the message closed. The alarm does not reappear
- **Note:** If you ignore the alarm, the AIS SART icon remains visible on your chart, and the AIS SART remains in the Vessels list.
- Save the waypoint
 - The waypoint is saved to your waypoint list. This waypoint name is prefixed with MOB AIS SART - followed by the unique MMSI number of the SART. For example, MOB AIS SART - 12345678.
- Activate the MOB function
 - The display switches to a zoomed chart panel, centered on the AIS SART position
 - The system creates an active route to the AIS SART position

- **Note:** If the MOB function is already active, this will be terminated and replaced by the new route towards the AIS SART position!
- **Note:** If the AIS stops receiving the AIS SART message, the AIS SART remains in the Vessels list for 10 minutes after it receives the last signal.

If you select the AIS SART icon on the chart panel, then you can see the AIS MOB details.

Vessel alarms

You can define several alarms to alert you if a target shows up within predefined range limits, or if a previously identified target is lost.

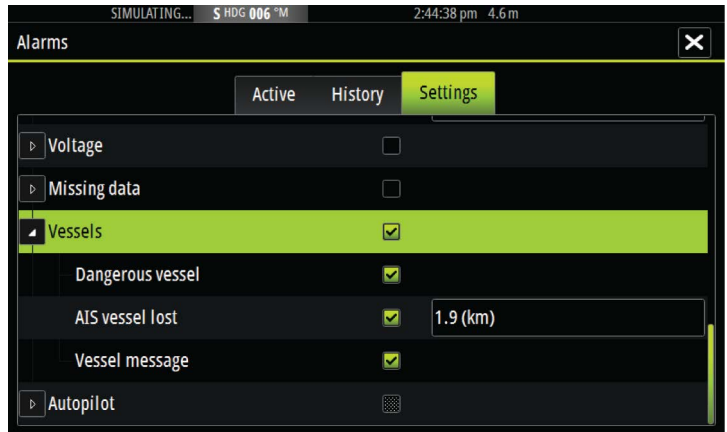
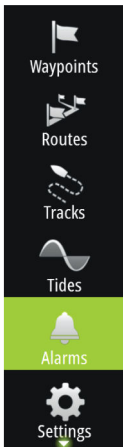

Dangerous vessel

Controls whether an alarm will be activated when a vessel comes closer than the distance for CPA within the time limit for TCPA. Refer to "Defining dangerous vessels" on page 175.

AIS vessel lost

Sets the range for lost vessels. If a vessel is lost within the set range, an alarm occurs.

- **Note:** The check box controls whether the alarm pop-up box is displayed and if the siren goes on. The CPA and TCPA define

when a vessel is dangerous regardless of the enabled or disabled state.

Vessel message

Controls whether an alarm will be activated when a message is received from an AIS target.

Vessel settings

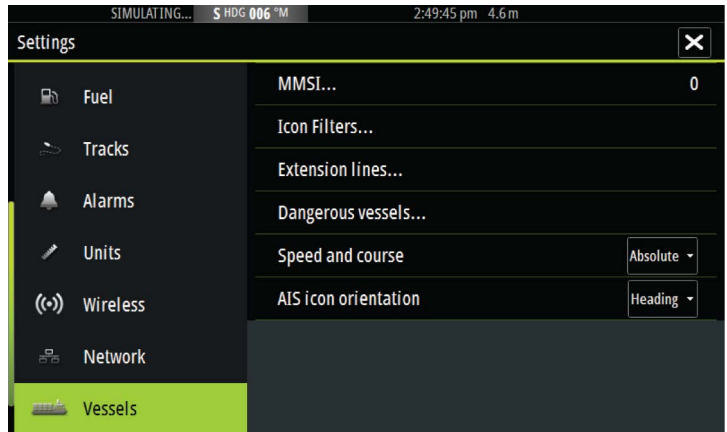
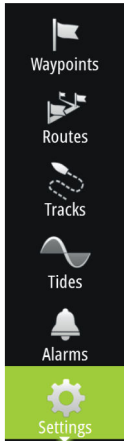

Your vessel's MMSI number

You need to have your own MMSI (Maritime Mobile Service Identity) number entered in the system to receive addressed messages from AIS and DSC vessels.

It is also important to have the MMSI number entered to avoid seeing your own vessel as an AIS target on the chart.

→ **Note:** The Vessel message option in the alarm settings must be toggled on for any MMSI message to be displayed.

Icon filters

By default, all targets are shown on the panel if an AIS device is connected to the system.

You can select not to show any targets, or to filter the icons based on security settings, distance, and vessel speed.

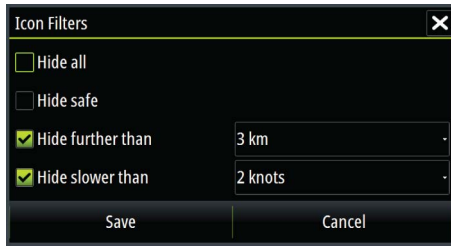

Extension lines

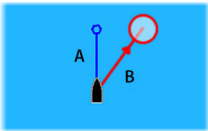

The length of the extension lines for your vessel and for other vessels can be set by the user.

- A: Heading
- B: Course Over Ground (COG)

The length of the extension lines is either set as a fixed distance, or to indicate the distance the vessel will move in the selected time period. If no options are turned on for **This vessel** then no extension lines are shown for your vessel.



Your own vessel heading information is read from the active heading sensor, and COG information is received from the active GPS.

For other vessels COG data is included in the message received from the AIS system.

Defining dangerous vessels

You can define an invisible guard zone around your vessel. When a target comes within the set limits, the symbol changes to the Dangerous target symbol. An alarm is triggered if activated in the Alarm settings panel.

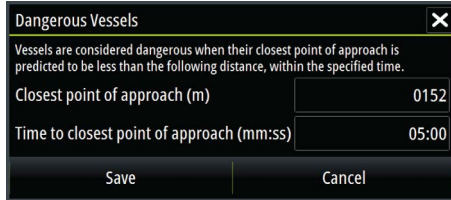

Speed and course indication

The extension line can be used to indicate speed and course for targets, either as absolute (true) motion in the chart or relative to your vessel.

A different line style is used on the extension lines to indicate motion, as shown below.

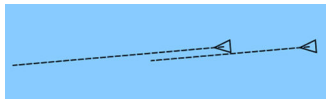

AIS vessels shown with Absolute motion



AIS vessels shown with Relative motion

AIS icon orientation

Sets the orientation of the AIS icon, either based on heading or COG information.

19

Instrument panels

The Instruments panels consist of multiple gauges - analog, digital and bar - that can be customized to display selected data. The Instruments panel displays data on dashboards, and you can define up to ten dashboards within the Instruments panel.

→ **Note:** To include fuel/engine information, engine and tank information has to be configured from the Settings panel.

Dashboards

A set of dashboard styles are predefined to display vessel, navigation, and angler information.

You switch between the panel's dashboards by selecting the left and right arrow buttons on the panel. You can also select the dashboard from the menu.



Vessel dashboard



Navigation dashboard



Angler dashboard

→ **Note:** Additional dashboards can be activated from the menu if other systems (e.g. CZone) are present on the network.

Customizing the Instruments panel

You can customize the Instruments panel by changing the data for each of the gauges in the dashboard, by changing the dashboard layout, and by adding new dashboards. You can also set limits for analog gauges.

All edit options are available from the Instruments panel menu.

Available editing options depend on which data sources are connected to your system.

Edit a dashboard

Activate the dashboard you want to edit, then:

1. Activate the menu
2. Select the edit option
3. Select the gauge you want to change. Selected gauge is indicated with a colored background
4. Select information to be displayed, configure limits, and eventually change the source for the information
5. Save your changes by selecting the save option in the menu

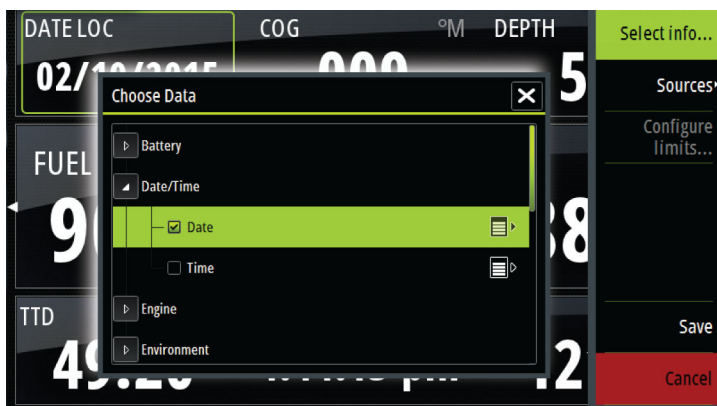
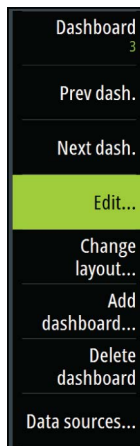

20

Audio

If a SonicHub server, a FUSION marine entertainment system, or compatible NMEA 2000 audio system is connected to the NMEA 2000 network, you can use the Vulcan Series to control and customize the audio system on your vessel.

You can connect a SiriusXM radio/tuner to compatible audio servers to receive SiriusXM radio on your system. The SiriusXM channels available vary depending on your selected subscription package. SiriusXM radio is only available in certain locations. For more information refer to www.siriusXM.com and the server documentation.

→ **Note:** SiriusXM audio is available if the unit has a Radar connection on the back. The Radar connection can be used as an Ethernet connection for SiriusXM audio.

Before you can start using your audio equipment, it must be installed according to the Vulcan Series Installation manual and to the documentation included with the audio device.

Enabling audio

A compatible audio device connected to the NMEA 2000 network should automatically be identified by the system. If not, enable the feature from the Advanced Settings dialog.

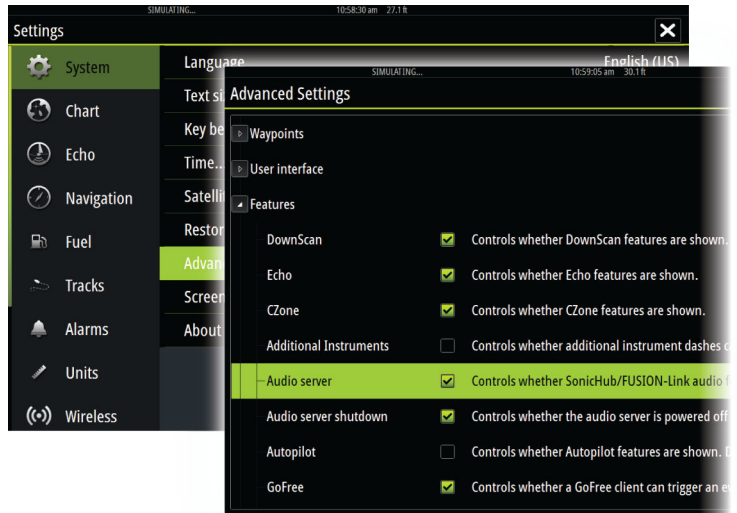
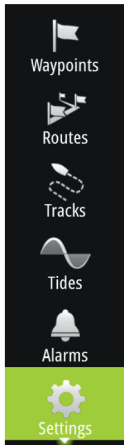

SonicHub 2

A SonicHub 2 connected to the NMEA 2000 network is supported.

SonicHub 2 Device Information

Open the Network Settings dialog and select the SonicHub 2 device in the Device list. This opens the SonicHub 2 Device Information dialog.

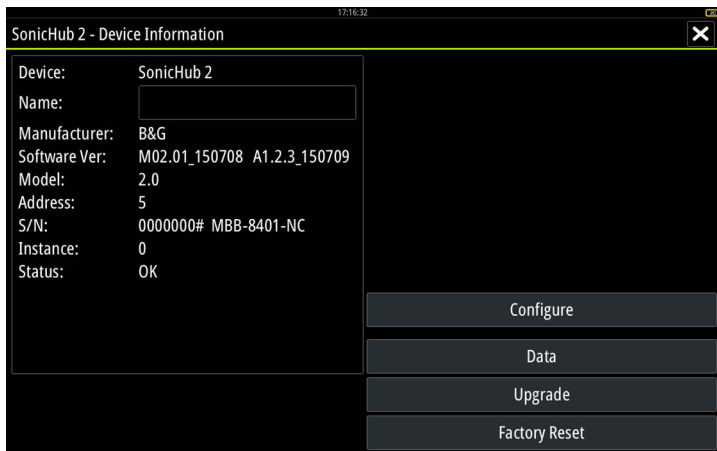

Configure

Select to configure the device.

Upgrade

Updates the device software.

→ **Note:** A USB memory stick with the software upgrade must be plugged into the device. Periodic software updates may be available from the product website. Detailed instructions for how to install the software are included with the upgrade files.

Factory Reset

Resets the device to factory defaults.

SonicHub 2 is Bluetooth enabled

The SonicHub 2 is a Bluetooth enabled device. You can use the SonicHub 2's built-in Bluetooth wireless to connect it to Bluetooth enabled audio devices.

To pair the SonicHub 2 to a Bluetooth enabled device select the Bluetooth devices icon in the Audio controller. Choose the Bluetooth device you want to pair to from the list of available devices and then select Pair.



The SonicHub 2 connects to the paired device.



Connecting and disconnecting paired devices

The SonicHub 2 automatically connects to a device when you pair them. You can pair it to several devices but only one device can be connected at a time.

You can manually disconnect and connect the SonicHub 2 to paired devices.

To disconnect a paired device, select the paired device in the device list and then select **Disconnect**.

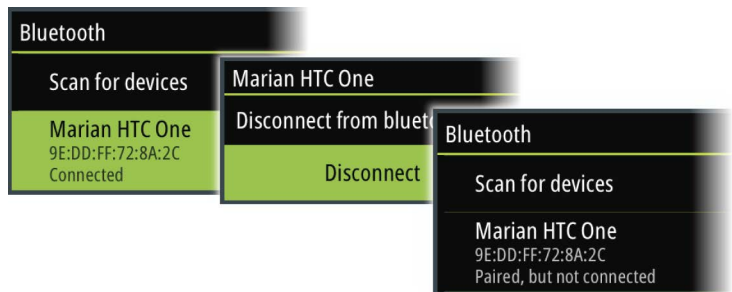

To connect to a paired device, select the paired device in the device list and then select **Connect**.

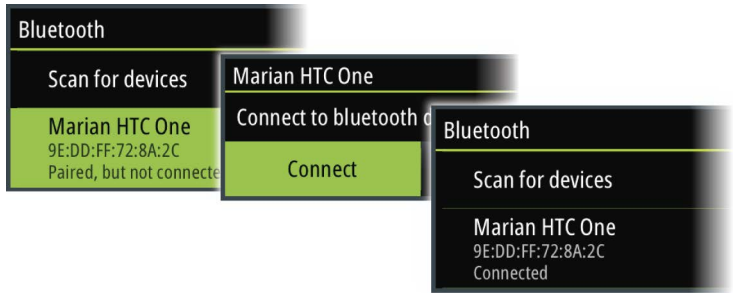

Pandora

The SonicHub 2 supports streaming music from Pandora from an Android device (over Bluetooth) or IOS device (over USB and Bluetooth).

→ **Note:** You must be in a valid location to use Pandora. Refer to the Pandora website for more information.

Use the Audio controller to run Pandora on the smart device.

The Audio controller

Activate the Audio controller by selecting Audio in the Control bar. The control buttons, tools and options vary from one audio source to another as described later in this chapter.











- 1 Audio controller
- 2 Audio source
- 3 Audio controller buttons
- 4 Audio controller tools

Audio control buttons





→ **Note:** VHF controls are available when audio servers with built in VHF receivers are connected.



The Mic source allows you to broadcast loud hailer messages over the audio system.

Icon	Tuner	VHF	DVD	Playback
	Select to display the list of available sources			
	Select to go to previous frequency. Press and hold to tune in a channel.		Select to rewind	Press and hold to rewind. Select to play previous track.
	Select to go to next frequency. Press and hold to tune in a channel.		Select to fast forward	Press and hold to fast forward. Select to play next track.
	Select to go to next/previous favorite channel		N/A	N/A
	N/A	N/A	Select to start	
	N/A	N/A	Select to pause playback	

Icon	Tuner	VHF	DVD	Playback
	Select to display the volume slider.			
	Select to mute.			
	Select to unmute.			

Audio tools

Icon	Tuner	VHF	Playback
	Signal strength	N/A	N/A
	N/A	N/A	Select to toggle on/off repeat function. The icon is colored when the function is active.
	N/A	N/A	Select to toggle on/off shuffle mode. The icon is colored when the function is active.
	Select to power on/off the active source. This button location is dependent on your unit's size. It is on the main Audio controller panel on larger units, and on the Audio controller's source panel on smaller units.		
	Select to display options for setting up zones and master control		

Icon	Tuner	VHF	Playback
	Select to display the favorite stations for the tuner	Select to display the favorite channels for the VHF	Select to display the Device explorer. Use the explorer to access the source's native controller or file structure and to select tracks.
	Select to display optional settings for active source		

Setting up the audio system

The speakers

Speaker zones

The Vulcan Series can be set up to control different audio zones. The number of zones depends on the audio server connected to your system.

You can adjust balance, volume and volume limit settings individually for each zone. Adjustments to the bass and tremble settings will alter all zones.

Master volume control

By default the volume for all speaker zones are adjusted when you adjust the volume. You can define which zones will be altered when you increase/decrease the volume.

Selecting tuner region

Before playing FM or AM radio, and using a VHF radio, you must select the appropriate region for your location.

Detaching Sirius from the AUX source

If a Sirius radio is connected to the FUSION radio/server, the AUX source is automatically attached to the Sirius feed. **Sirius** then appears in the source list when the FUSION server is active.

To use the AUX source for a different device, the Sirius must be detached from the AUX source.

→ **Note:** To use SiriusXM, an optional SiriusXM tuner must be connected to the FUSION server.

Operating the audio system

1. Select Audio in the Control bar to open the Audio controller
2. Select the Audio source button and then select the audio source
 - Number of sources depends on the active audio server
3. Use the controller buttons to control your audio system

For an overview of audio control buttons and tools, refer to "*Audio control buttons*" on page 183. Also see "*Audio Tools*" on page 184.

For available options, refer to the documentation following your audio equipment.

Favorite channels

When a tuner or VHF channel is tuned in, you can add the channel to your favorite list. The favorite channels can be viewed, selected and deleted from within the Favorite list.

You page through favorite channels by using the up/down Audio controller buttons.

Sirius radio (North America only)

Channels list

The channels list displays all available Sirius channels, whether or not you have a subscription for the channel.

Favorites list

You can create a list of your favorite Sirius channels from within the channels list. You cannot add unsubscribed channels.

Locking channels

You can lock selected Sirius channels from being broadcasted. A 4-digit-code must be entered to lock channels and the same code entered to unlock the channels.

21

Weather





The system includes weather functionality that allows the user to view forecast data overlaid on the chart. This helps gaining a clear understanding of the weather conditions that are likely to appear.

The system supports weather data in GRIB format, available for download from various weather service suppliers.

Wind barbs

The rotation of the wind barbs indicate the relative wind direction, with the tail showing the direction the wind is coming from. In the graphics below, the wind comes from the northwest.

Wind speed is indicated by a combination of small and large barbs at the end of the wind tail.

	Zero knots / Indeterminate wind direction
	Small barb = 5 knots
	Large barb = 10 knots
	Arrow barb = 50 knots

If a combination of 5 and 10 knot barbs are shown on a tail, then add them together to give you the total wind speed. The example below shows 3 x large barb + 1 x small barb = 35 knots, and 60 knots indicated with 1 x arrow barb + 1 x large barb.



Wind speed: 35 knots



Wind speed: 60 knots

Showing weather details

If pop-up is enabled, you can select a weather icon to display the identity of the observation. If you select the pop-up, detailed information about the observation is displayed. You can also display

the detailed information from the menu when the weather icon is selected.

GRIB weather

A GRIB file contains forecast information for a set number of days. It is possible to animate the weather data, which shows how weather systems are developing.

Importing GRIB data

GRIB data imported into memory can be displayed as chart overlay. Refer to "*Displaying GRIB weather as overlay*" on page 190. The file can be imported from any location that can be seen in the file manager.

→ **Note:** GRIB data that is imported overwrites the GRIB data in memory.

You can import the weather file using the File manager from the Tools panel or the Forecast menu option on the Chart panel:

- When you select a GRIB file with the File manager, the import option is available. Use it to import a GRIB file into memory.

Select the GRIB file to import the data.

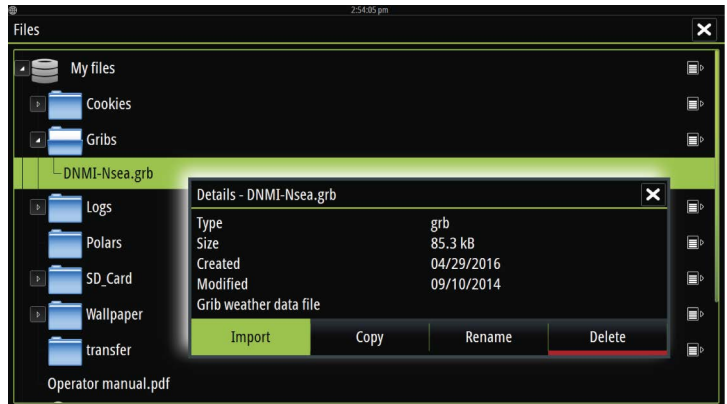
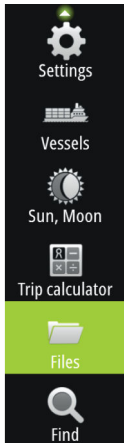

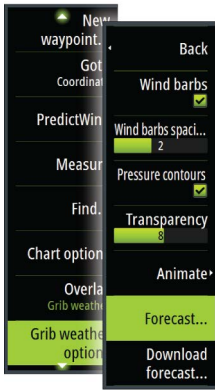

- Selecting the Forecast menu option on the Chart panel displays the GRIB weather dialog. Use the import file option in this dialog to open the File manager and import a GRIB file into memory. Using this dialog you can also select an available GRIB file. Selecting an available GRIB file is the same as importing the file into memory. Available GRIB files are files downloaded from a weather service supplier to the Grib directory (in the Files manager).

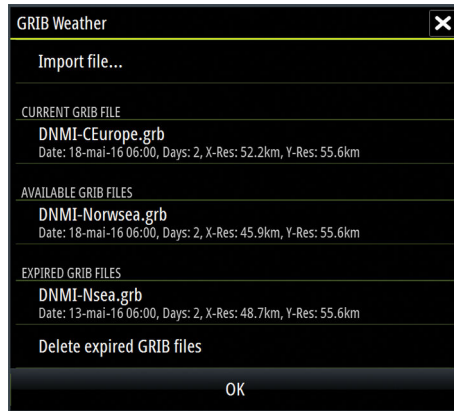

Displaying GRIB weather as overlay

Imported GRIB weather data can be displayed as an overlay on your chart panel.

When the GRIB weather overlay is selected, the chart menu increases to show GRIB weather options. From this menu you can select which weather symbols you want to display, set the distance between the barbs, and adjust the opaqueness of the weather symbols.

From this menu you can also animate the weather forecast. Refer to *"Animating GRIB weather forecast"* on page 191.

The Forecast menu option displays the GRIB file currently in memory and overlaid on the chart. Select the Forecast menu option to import a new GRIB file into memory. Importing a new file overwrites the GRIB data in memory.



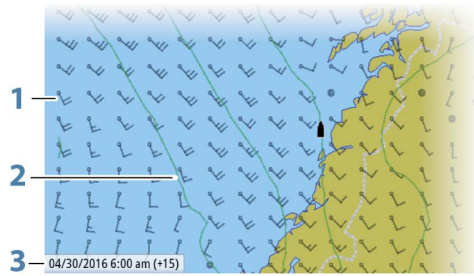

- 1 Wind barbs
- 2 Pressure contours
- 3 GRIB information window

GRIB information window

The GRIB information window shows the date and time for the GRIB weather forecast, and the selected forecast time in brackets. A negative value in the brackets indicates historic weather data.

If you select a position on the chart, the information window expands to include weather details for the selected position.

Animating GRIB weather forecast

The GRIB data contains forecast information for a set number of days. It is possible to animate the weather data and to show the predicted forecast for a specific time and date. The time scales vary depending on the file you are using.

The time shift is shown in brackets in the GRIB information window. The time is relative to the current time as provided by a GPS device connected to the system.

Select time and animation speed from the menu.

PredictWind weather and routing

For information about PredictWind weather and PredictWind routing, refer to "*PredictWind*" on page 86.

SiriusXM weather

When connected to a Navico Weather module, you can subscribe and include Sirius audio and Sirius Marine Weather Service on your system (North America only).

→ **Note:** SiriusXM weather is available if the unit has a Radar connection on the back. The Radar connection can be used as an Ethernet connection for SiriusXM weather.

Depending on your selected subscription package, Sirius audio and weather service covers a variety of North American inland waters and coastal areas. For more information refer to www.siriusxm.com/sxmmarine.

Sirius status panel

When the weather module is connected to the system, you get access to the Sirius status panel.

The status panel shows signal strength is indicated as 1/3 (weak), 2/3 (good) or 3/3 (preferred). It also includes antenna status, service level, and the electronic serial number for the weather module.

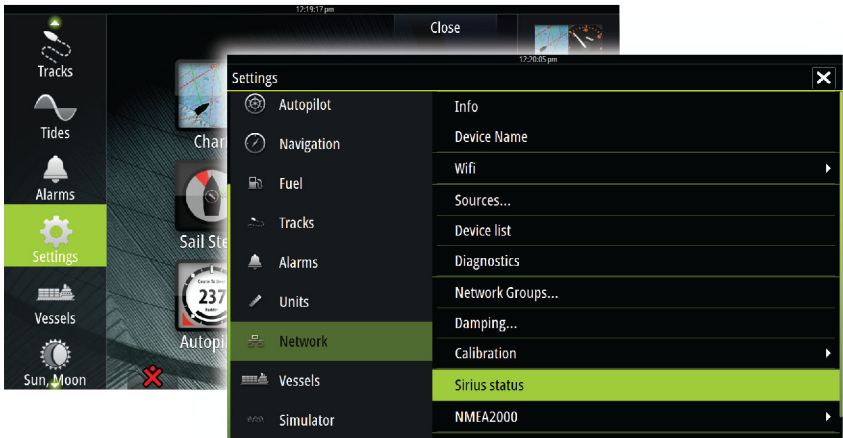

Sirius weather display

Sirius weather can be displayed as an overlay on your chart panel.

When weather overlay is selected, the chart menu increases to show the available weather options.

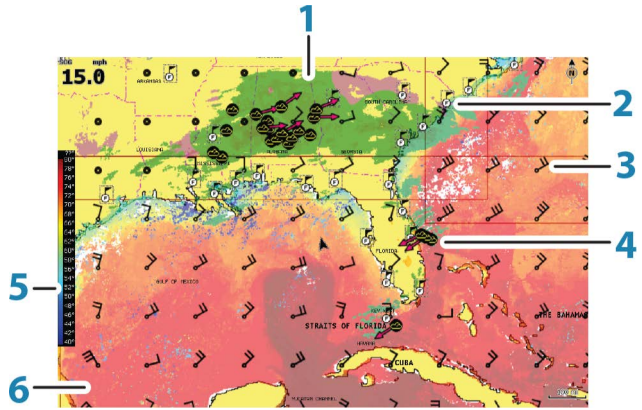

- 1 Precipitation color shading
- 2 City forecast icon
- 3 Wind barb
- 4 Storm icon
- 5 SST color bar
- 6 SST color shading

Use the Sirius weather option menu to select which weather symbology that should be displayed and how they should appear on the chart panel.

Sirius view options

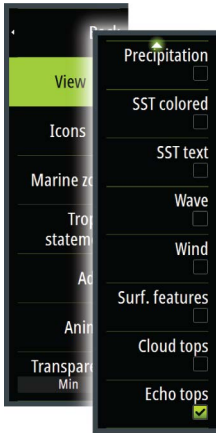

Precipitation

Shades of color are used to show precipitation type and intensity. The darkest color indicates the highest intensity.

Rain	From light green (light rain) - yellow - orange - to dark red (heavy rain)
Snow	Blue
Mixed	Pink

Sea Surface Temperature (SST)

You can show the sea surface temperature as color shading or as text.

When color coding is selected, the SST color bar is shown on the left side of the display.

You define how the color codes are used to identify sea surface temperature. See "*Adjusting color codes*" on page 197.

Wave indication

Colors are used to indicate forecasted wave height. The highest waves are dark red, while the lowest are blue.

You can define how the color codes are used to identify the wave height. Refer to "*Adjusting color codes*" on page 197.

Surface features

Turns surface features on/off. Surface features include fronts, isobars, and pressure points. Surface features cannot be shown at the same time as Wind.

Cloud tops

Turn Cloud tops on/off. Cloud tops indicate the height of the top of the clouds. The color palette used is grey with darker greys indicating lower clouds. Cloud tops cannot be shown at the same time as Precipitation or Echo Tops.

➔ **Note:** This feature is only available for certain SiriusXM subscriptions.









Echo tops

Turns Echo tops on/off. Echo tops indicate the tops of storms. The color palette used is the same as for Precipitation. Echo tops cannot be shown at the same time as Precipitation or Cloud Tops.

→ **Note:** This feature is only available for certain SiriusXM subscriptions.

Weather icons

Several weather icons are available to show current or predicted weather conditions. You can select an icon to display detailed weather information.

	City forecast
	Surface observation
	Tropical storm tracking; past (grey) - present (red) - future (yellow)
	Hurricane (category 1-5) tracking; past (grey) - present (red) - future (yellow)
	Tropical disturbance/depression tracking; past (grey) - present (red) - future (yellow)
	Storm attributes
	Lightning
	Watch box location and warning
	Marine zone location

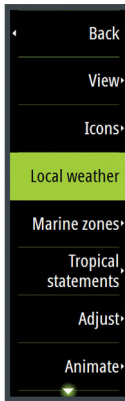

Local weather

Select the Local weather menu option to display the Local weather dialog. This dialog shows weather forecast and alerts for the area. Select a time-slot tab to see the forecast for it.

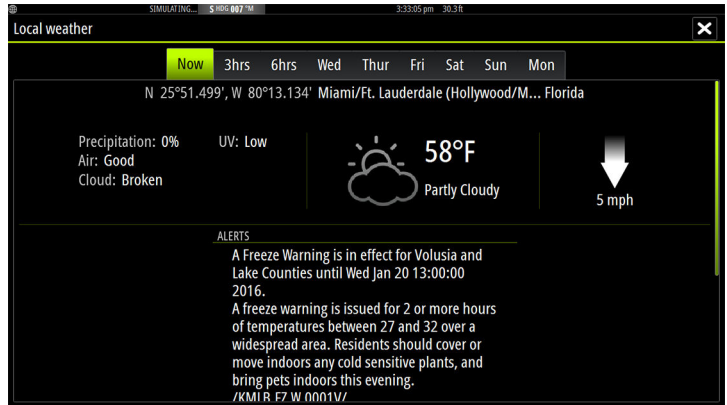

Marine zones

Depending on your selected subscription, SiriusXM services includes access to weather reports for U.S. and Canadian Marine Zones, with the exception of the high seas zones.

You can select a marine zone on a chart and view its forecast. You can also select a marine zone as your current zone of interest and you will be notified of any weather warnings in that zone.

Tropical statements

You can read tropical statements including information about tropical weather conditions. These statements are available for the entire Atlantic and the Eastern Pacific.

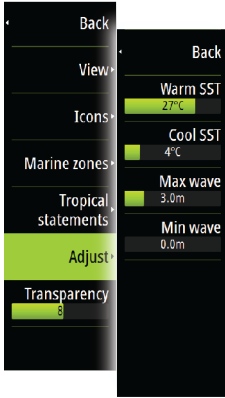

Adjusting color codes

You can define the sea surface temperature range and wave height color coding.

The temperature above warm and below cool values is displayed as progressively darker red and darker blue.

Waves higher than the maximum value are indicated with progressively darker red. Waves lower than the minimum value are not color coded.

Animating Sirius weather graphics

The Vulcan Series records the weather information you have turned on, and this information can be used to animate past or future weather conditions. The amount of information available in the system depends on the amount of weather activity; the more complex it is, the less time that is available for animation.

You can animate the past or the future, depending on which weather view you have turned on:

- With precipitation overlay, you can animate for the past and only assume weather conditions in the immediate future.
- With colored wave height overlay, you can animate the future (the predictions).

When activated, the time for the current graphic animation is displayed in the lower left corner of the chart panel.

22

Alarms

Alarm system

The system continuously checks for dangerous situations and system faults while the system is running. When an alarm situation occurs, an alarm message pops up on the screen.

If you have enabled the siren, the alarm message is followed by an audible alarm, and the switch for external alarm becomes active.

The alarm is recorded in the alarm listing so that you can see the details and take the appropriate corrective action.

Type of messages

The messages are classified according to how the reported situation affects your vessel. The following color codes are used:

Color	Importance
Red	Critical
Orange	Important
Yellow	Standard
Blue	Warning
Green	Light warning

Single alarms

A single alarm is displayed with the name of the alarm as the title, and with details for the alarm.

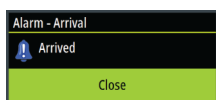

Multiple alarms

If more than one alarm is activated simultaneously, then the alarm message displays a list of up to 3 alarms. The alarms are listed in the order they occur with the alarm activated first at the top. The remaining alarms are available in the Alarms dialog.



Acknowledging a message

The following options are available in the alarm dialog for acknowledging a message:

- **Close**
Sets the alarm state to acknowledged, meaning that you are aware of the alarm condition. The siren / buzzer stops and the alarm dialog is removed.
However, the alarm remains active in the alarm listing until the reason for the alarm has been removed.
- **Disable**
Disables the current alarm setting. The alarm does not show again unless you turn it back on in the Alarms dialog.

There is no time-out on the alarm message or siren. They remain until you acknowledge the alarm or until the reason for the alarm is removed.

Alarms dialog

All alarms are setup in the Alarms Settings dialog.

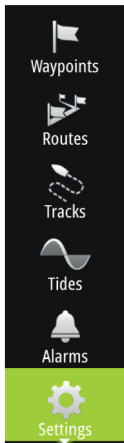

The alarm dialogs can also be activated from the Tools panel. The alarm dialogs include information about active alarms and alarm history.

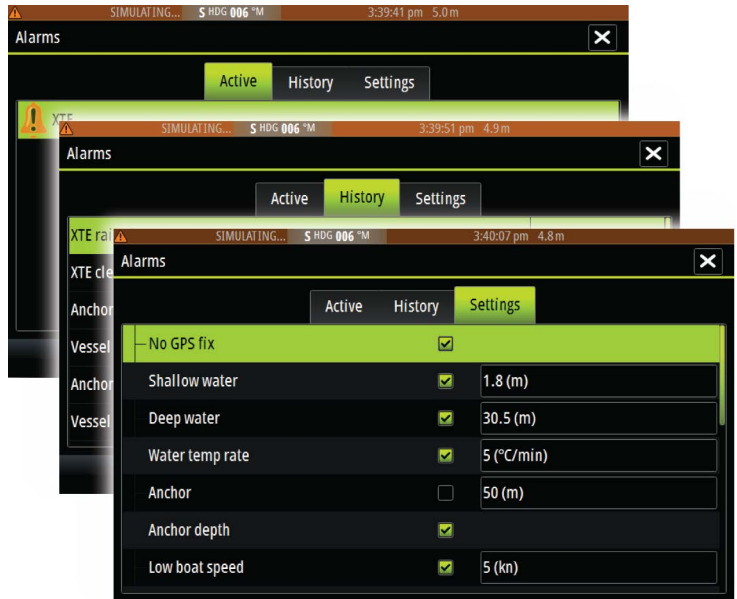
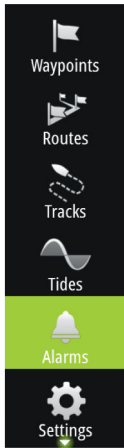

23

Tools

By default, the Tools panel includes icons used for accessing options and tools that are not specific to any panel.

When external equipment is integrated to the unit, new icons might be added to the Tools panel. These icons are used for accessing the external equipment's features.



Waypoints/routes/tracks

List of waypoints, routes, and tracks with details.

Select the waypoint, route, or track you wish to edit or delete.

Tides

Displays tide information for the tide station nearest to your vessel.

Select the arrow panel buttons to change the date, or select the date field to access the calendar function.

Available tide stations can be selected from the menu.

Alarms

Active alarms

List of active alarms.

Alarm history

List of all alarms with time stamp.

Alarm settings

List of all available alarm options in the system, with current settings.

Settings

Provides access to application and system settings.

Vessels

Status listing

List of all AIS and DSC vessels with available information.

Message listing

List of all messages received from other AIS vessels with time stamp.

Sun, Moon

Displays sunrise, sunset, moonrise and moonset for a position based on entered date and the position's latitude/longitude.

Trip calculator

Trip 1 / Trip 2

Displays voyage and engine information, with reset option for all data fields.

Today

Displays voyage and engine information for current date. All data fields are automatically reset when the date changes.

Files

File management system, used to browse the contents of the unit's internal memory and inserted SD card.

Viewing files

Select a file in the Files panel and then the view file option in the **Details** dialog.

Copying files to a card in the card reader

You can copy screen captures and logs to a card in the card reader. You can also export System Settings, Waypoints, Routes, and Tracks to a card. Exporting files is covered in the section "*Maintenance*" on page 206.

Find

Search function for chart items (waypoints, routes, tracks, etc.).

GoFree Shop

→ **Note:** The built-in wireless functionality must be connected to an external wireless hotspot in order to access the GoFree Shop. Refer to "*Connect and disconnect from a wireless hotspot*" on page 162.

Opens the GoFree Shop web site. At the GoFree Shop you can browse, purchase, and download compatible charts for your system. You can also upload your Echosounder logs to be shared on Social Map charts. When you log on, the system automatically gives you a notification if a new software version is available for your system. If an update is available, you can download it to a card slot or defer the download until later.

24

Simulator

The simulation feature lets you see how the unit works in a stationary position and without being connected to sensors or other devices.

The status bar indicates if the simulator is toggled on.

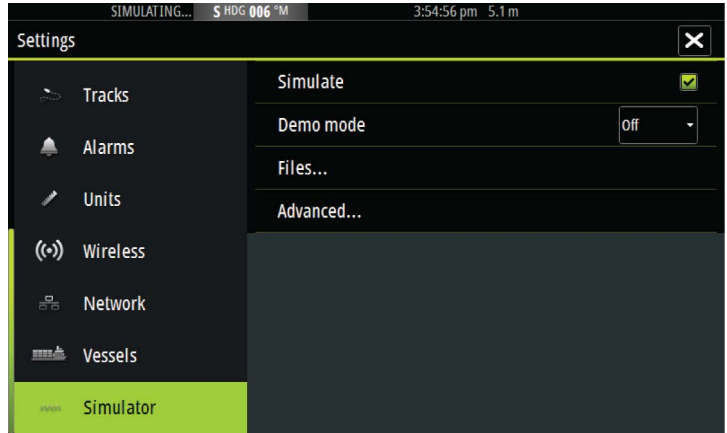
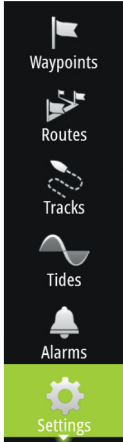

Demo mode

In this mode the unit automatically runs through the main features of the product; it changes pages automatically, adjusts settings, opens menus, etc.

If you tap on the touchscreen when demo mode is running, the demonstration pauses. After a time-out period, demo mode resumes and any changed settings are restored to default.

→ **Note:** Demo mode is designed for retail/showroom demonstrations.

Simulator source files

You can select which data files are used by the simulator. A set of source files is included in your system, and you can import files by using a card inserted into the card reader. You can also use your own recorded log data files in the simulator.

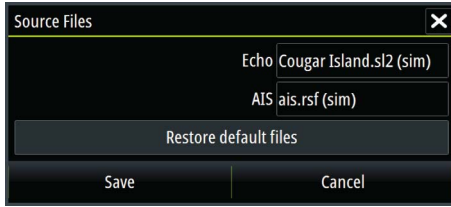

Advanced simulator settings

The Advanced simulator settings allows for manually controlling the simulator.

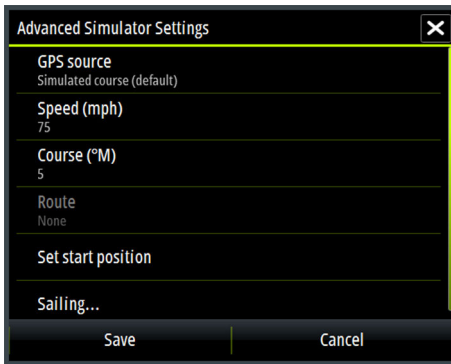

25

Maintenance

Preventive maintenance

The unit does not contain any field serviceable components. Therefore, the operator is required to perform only a very limited amount of preventative maintenance.

It is recommended that you always fit the supplied protective sun cover when the unit is not in use.

Cleaning the display unit

A proper cleaning cloth should be used to clean the screen, where possible. Use plenty of water to dissolve and take away salt remains. Crystallized salt may scratch the coating if using a damp cloth. Apply minimal pressure to the screen.

Where marks on the screen cannot be removed by the cloth alone, use a 50/50 mixture of warm water and isopropyl alcohol to clean the screen. Avoid any contact with solvents (acetone, mineral turpentine, etc.), or ammonia based cleaning products, as they may damage the anti-glare layer or plastic bezel.

To prevent UV damage to the plastic bezel, it is recommended that the sun cover be fitted when the unit is not in use for an extended period.

Cleaning the media port door

Clean the media port door regularly to avoid salt crystallization on the surface, causing water to leak into the card slot.

Checking the connectors

The connectors should be checked by visual inspection only.

Push the connector plugs into the connector. If the connector plugs are equipped with a lock, ensure that it is in the correct position.

Software upgrades

The latest software is available for download from our website, www.bandg.com.

Before initiating an update to the unit itself, be sure to back up any potentially valuable user data. Refer to *"Backing up your system data"* on page 208.

The system or the Network analyzer and service assistant can advise software updates are available.

Network analyzer and service assistant

The system has a built-in service assistant that creates a report of the devices installed on the NMEA 2000 network such as the software versions, serial numbers, and information from the settings file to assist in technical support enquiries.

To use the analyzer, open the About page of the System settings dialog and select Support. Two options are displayed:

Create report

Analyzes your network and prompts you for information required for support and creates the report with information automatically gathered from the network. You can add screenshots and log files that will be attached to the report. There is a 20MB limit for the report attachments. You can save the report to a memory card and email it to support or upload it directly if you have an internet connection. If you call technical support first, you can enter an incident number to assist with tracking.

Check system for updates

Analyzes your network and checks if updates are available for compatible devices.

→ **Note:** Connect your unit to the internet to check for the latest available software versions. The software versions will be up to date as of the last time you updated your unit or connected to the internet.

Update software

→ **Note:** Remove any mapping cards from your unit and install a memory card with sufficient storage before downloading software updates or creating and saving reports to the memory card.

→ **Note:** Do not turn off the MFD or device until the update is completed or you are prompted to restart the unit or device being updated.

1. If your MFD is connected to the Internet, you can download the software update from the **Updates Dialog** into a memory card. You can also download the software update from www.bandg.com to a memory card inserted in a smart device or PC connected to the internet.
2. Insert the card containing the software updates in your MFD.
3. Select the item to be updated in the **Updates Dialog** and follow the prompts.

As you respond to the prompts the update occurs. Prompts may request that you restart the device to complete the update. You can restart devices to complete the update later at a more convenient time.

Backing up your system data

Waypoints, Routes, and Tracks that you create are filed in your system. It is recommended to regularly copy these files and your system settings files as part of your back-up routine. The files can be copied to a card inserted in the card reader.

There are no export file format options for the system settings file. The following output formats are available for exporting Waypoints, Routes, and Tracks files:

- **User Data File version 5**
This is used to import and export waypoints and routes with a standardized universally unique identifier (UUID), which is very reliable and easy to use. The data includes such information as the time and date when a route was created.
- **User Data File version 4**
This is best used when transferring data from one system to another, since it contains all the extra bits of information these systems store about items.
- **User Data file version 3 (w/depth)**
Should be used when transferring user data from one system to a legacy product (Lowrance LMS, LCX)
- **User data file version 2 (no depth)**
Can be used when transferring user data from one system to a legacy product (Lowrance LMS, LCX)
- **GPX (GPS Exchange, no depth)**
This is the format most used on the web that shares among most GPS systems in the world. Use this format if you are taking data to a competitor's unit.

- **Northstar.dat (no Tracks)**

Used to transfer data to a legacy Northstar device.

Export all Waypoints, Routes and Tracks

Use the export option if you want to backup all Waypoints, Routes, Tracks and Trips on your system.

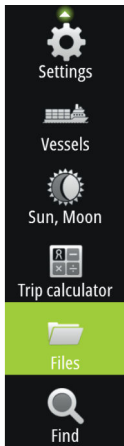

Export region

The export region option allows you to select the area from where you want to export data.

1. Select Export region
2. Drag the boundary box to define the desired region



3. Select the export option from the menu
4. Select the appropriate file format
5. Select Export to start the export

Purging Waypoints, Routes and Tracks

Deleted Waypoints, Routes and Tracks are stored in the display unit's memory until the data is purged. If you have numerous deleted, unpurged Waypoints, purging may improve the performance of your system.

→ **Note:** When user data is purged from the memory, it cannot be recovered.

Importing a database





Later, if the unit has been restored to factory defaults or user data is accidentally deleted, return to the files page, select the backed up file, and then **Import**. View file details for creation date.



26

Touchscreen operation

Basic touchscreen operation on the different panels is shown in the table below.

The panel sections in this manual have more information about panel specific touchscreen operation.

Icon	Description
	Tap to: <ul style="list-style-type: none">• Activate a panel on a multi-panel page• Position the cursor on a panel• Select a menu and a dialog item• Toggle a checkbox option on or off• Show basic information for a selected item
	Press and hold: <ul style="list-style-type: none">• On a panel button to see available split screen options• On a favorite button to enter edit mode
	Scroll through a list of available options without activating any option.
	Flick to quickly scroll through e.g. the waypoint list. Tap the screen to stop the scrolling.
	Pan to position a chart or Echosounder image on the panel.

Icon	Description
	Pinch to zoom out on the chart or on an image.
	Spread to zoom in on the chart or on an image.

Index

A

- Active panel 22
 - Adjusting panel size 24
 - AIS 168
 - Calling a vessel 170
 - DSC 170
 - Icon filters 173
 - Icon orientation 175
 - Searching for AIS items 169
 - Target symbols 168
 - Viewing information about targets 169
 - AIS SART 170
 - Alarm message 171
 - Alarm
 - Critical Zone 159
 - Alarms
 - Acknowledging 199
 - Alarm settings dialog 199
 - Multiple alarms 198
 - Single alarm 198
 - Type of messages 198
 - App
 - GoFree Link 163
 - Application pages 14
 - Arrival alarm 70
 - Arrival radius 69
 - Audio 178
 - Controller 182
 - Control buttons 183
 - Detaching Sirius 186
 - Enable 178
 - Favorite channels 186
 - Master volume control 185
 - Operating 186
 - Selecting tuner region 185
 - Setting up the system 185
 - Sirius radio 186
 - Speaker zones 185
 - Speakers 185
 - Audio tools 184
 - Auto gain 137
 - Autopilot 98
 - Activating 98
 - AUTO mode (Heading hold) 102
 - Autopilot controller 99
 - Autopilot panel 100
 - Chart compass 107
 - Dodging 104
 - Follow-up steering 102
 - Gybing 107
 - Heading hold (AUTO mode) 102
 - Indication in Status bar 99
 - Indication on pages 99
 - Modes 101
 - Non-Follow up mode 101
 - Settings 107
 - Standby (STBY) mode 101
 - Switching to manual steering 98
 - Tacking in AUTO mode 103
 - Tacking in WIND mode 106
 - Waypoint arrival circle 105
 - Autopilot :WIND mode 106
 - Autorouting, see Dock-to-dock Autorouting 60
 - Autorouting
 - Dock-to-dock 60
- ## B
- Backing up your system data 208
 - Bottom lock 141

C

- C-MAP chart options 40
- Card
 - Copying files to 202
- Charts 29
 - 3D charts 35
 - C-MAP chart options 38
 - Chart compass 107
 - Chart data 30
 - Chart panel 29
 - Chart scale 31
 - Course up 32
 - Creating routes 35
 - Embedded cartography 30
 - Find chart objects 35
 - Heading up 32
 - Insight chart options 38
 - Look ahead 32
 - Measuring distance 34
 - Navionics chart options 45
 - North up 32
 - Orientation 31
 - Overlay 38
 - Panning 31
 - Positioning the vessel on the chart panel 31
 - Radar overlay source 116
 - Selecting chart type 31
 - Settings 50
 - Using the cursor 33
 - Vessel symbol 31
 - Zooming 31
- Charts
 - Symbol 31
- Color 137
- Color tracks
 - Based on data 36
- Connect
 - Smartphone and tablet 163

- Wireless hotspot 162
- Control bar 15
- Controller and viewer app
 - GoFree Link 163
- Converting tracks to routes 63
- Coordinate system 70
- Copying files to a card 202
- Critical Depth 159
- Critical Forward Range 159
- Critical Zone alarm 159
- Cursor assist 33, 118, 134, 147
 - Customize the long press feature 25
- Customizing your system 24
- CZone 17

D

- Dangerous vessels 175
- Dashboards 176
- Database
 - Import 210
- Datum 70
- Demo mode 204
- Departure planner
 - PredictWind 92
- Depth line 142
- Depth offset 161
- Dialog boxes 21
- Disconnect
 - Wireless hotspot 162
- Display illumination 20
- Dock-to-dock Autorouting
 - Entire route 60, 61
 - Example 61
 - Selection 60, 61
- Doppler coloring 121
- Dual Radar 115
- Dual range, Radar 117

E

- Easy Routing 60
 - Example 61
- EBL/VRM markers 127
- Echosounder 133
 - A-Scope 142
 - Depth offset 161
 - Image 133
 - Pausing 137
 - Start recording echosounder data 138
 - Stop recording log data 140
 - Using the cursor 134
 - View history 135
 - View options 141
 - View recorded data 141
 - Zoom bar 133
 - Zoom bars 142
 - Zooming 133
- Echosounder
 - Split Zoom 141
- Export region 209
- Extension lines 174

F

- Favorite pages 16
 - Adding new 26
 - Edit 27
- Favorites 22
- Feature unlock 16
- Files to a card, copying 202
- Files, management 202
- Files
 - Viewing 202
- Find items tool 202
- ForwardScan 156
 - Critical Depth 159
 - Critical Forward Range 159

- Critical Zone alarm 159
- Heading extension 158
- Image 156
- Installation 144
- Setup 159
- Transducer angle 160
- Frequency 136
- FUSION-Link 17, 178

G

- Gain 136
- Go to cursor 33, 117, 134, 146
- GoFree
 - Shop 163
 - Wireless connection 162
- GoFree
 - Link 163
 - Smartphone connection 164
 - Tablet connection 163
- Great circle 69
- GRIB weather 189
 - Animated weather forecast 191
 - Importing data 189
 - Information window 191
 - Overlay on chart panel 190

H

- H5000 18
- Home page 13
- Home page background 24

I

- Illumination 20
- Import
 - Database 210

- Improving system performance 210
- Insight chart options 40
- Instrument bar 27
 - Activity bar 28
 - Appearance 27
 - Edit the content 28
 - Turning on/off 28
- Instrument panels 176
- Integration of 3rd party devices 16
- Internet usage 4

L

- Locking the touchscreen 20
- Long press feature
 - Customize 25

M

- Magnetic variation 70
- Man Overboard
 - Cancel navigation to MOB 22
 - Creating a MOB 22
 - Delete a MOB waypoint 22
- Manual
 - About 5
 - Version 5
- Manuals, viewing 5
- Measuring distance 34, 135, 147
- Menus 21
- MMSI number 173

N

- Navigate 67
 - Arrival alarm 70
 - Arrival radius 69
 - Datum 70

- Methods 69
 - Great circle 69
 - Rhumb lines 69
- Routes 67
 - To cursor position 67
 - With autopilot 68
- Navigation settings 69
- Navionics chart options 45
- Noise rejection 138

O

- Operation
 - Touch 211
- Overlay downscan 143
- Overlay
 - SailSteer on Chart 73

P

- Pages
 - Selecting a page 21
 - Selecting active panel 22
- Palettes 141, 149
- Panels
 - Adjusting panel size 24
- Password protection 25
- PDF, viewing files 5
- Phantom Loran 70
 - Settings 70
- Pin code
 - Password protection 25
- Ping speed 138
- PredictWind Routing
 - Summary info 97
- PredictWind
 - Weather routing 92
- PredictWind
 - Departure planner 92
 - Routing download management 97
 - weather 86

Preventive maintenance 206
Purging 210

R

Race panel 74
Race timer 81
Radar 114
 Alarm settings 128, 130
 Course up 124
 Dual 115
 Dual range 117
 EBL/VRM markers 127
 EBL/VRM
 Placing 127
 EBL/VRM
 Offset 127
 Fast scan 121
 Gain 119
 Guard zone 128
 Head-up 124
 Interference 120
 MARPA
 Target symbols 129
 Targets 129
 Tracking targets 130
 View target info 130
 Motion mode 125
 North up 124
 Operational modes 116
 Orientation 124
 Overlay 115
 Palette 124
 Radar overlay source 116
 Radar panel 114
 Rain clutter 119
 Range 117
 Recording data 130
 Sea clutter 119
 Sea State 121
 Sensitivity 129

 Settings 131
 Source 115
 Target boost 121
 Target expansion 120
 Target trails 124
 Threshold 120
Range 136
Record echosounder
data 150
Recording
 Start recording echosounder
 data 138
 Start recording log
 data 138
Rhumb lines 69
Routes 58
 Converting tracks to
 routes 63
 Creating a new route on the
 chart panel 58
 Creating a route from
 existing waypoints 62
 Delete 58
 Dialog 66
 Dock-to-dock
 Autorouting 60
 Easy Routing 60
 Edit in chart panel 58
 Edit Route dialog 64
 Navigate 67
 PredictWind Routing
 download
 management 97
 PredictWind weather
 routing 92

S

Sail time calculations 72
SailSteer
 Data fields 72

- Overlay 73
- Panel 71
- Saving waypoints 34, 56, 118
- Screen capture 23
- Scroll speed 138
- Sea State 121
- Settings
 - Autopilot 107
 - Tools 201
- Simulator 204
 - Demo mode 204
 - Source files 204
- Sirius radio 186
 - Channels list 186
 - Favorite list 186
 - Locking channels 187
- Sirius weather
 - Animated weather graphics 197
 - Color codes 197
 - Marine zones 196
 - Overlay on chart panel 192
 - Precipitation 194
 - Sea Surface Temperature (SST) 194
 - Status panel 192
 - Tropical statements 196
 - Wave indication 194
 - Weather icons 195
- SiriusXM weather 192
- SL2 format 139
- SL3 format 139
- SLG format 139
- SmartCraft VesselView 17
- Smartphone connection 164
- Software upgrade 206
- Software version 6
- Software
 - How to update 207
- SonicHub 178
- Speaker zones 185
- Speakers 185
- Speed and course indication 175
- Split pages 15
 - Pre-configured 15
- Split zoom
 - Echosounder 141
- Start line
 - Data panel 75
 - Display 79
- StructureMap 140, 151
 - Activate 151
 - Image 151
 - Live source 152
 - Mapping cards 154
 - Options 154
 - Saved files 152
 - Sources 152
 - Tips 153
- StructureScan 145
 - Advanced settings 149
 - Auto range 148
 - Contrast 148
 - Convert data to StructureMap format 153
 - Flipping the image 149
 - Frequencies 148
 - Image 145
 - Noise rejection 155
 - Pausing the image 149
 - Preset range levels 148
 - Range 148
 - Range lines 150
 - Recording data 153
 - Using the cursor 146
 - View down or side scan 149
 - View history 148
 - View options 145
 - Zooming 146
- System Controls dialog 19

- System Settings
 - Coordinate system 70
 - Datum 70
 - Magnetic variation 70

T

- Tablet connection
 - GoFree, wireless 163
- Temperature graph 141
- Time plot panel 84
 - Missing data 84
- Time plots 84
 - Selecting data 84
- Tools 201
- Tools
 - Find items 202
 - Settings 201
- Touch
 - Operation 211
- Touchscreen
 - Locking 20
- Tracks
 - Dialog 66
- Tracks
 - Coloring 36
 - Creating new 65
 - Settings 65
- Transducer angle, ForwardScan 160
- Turning the unit on and off 19
- TVG 138, 149

U

- Unit
 - Checking the connectors 206
- Update software 207

V

- VelocityTrack 121
- Vessel alarms 172
- Vessel settings 173
- View Echosounder log 143
- Viewing files 202

W

- Wallpaper, customizing 24
- Warranty 4
- Waypoints, routes, trails and trips
 - Export 209
- Waypoints 56
 - Alarm settings 57
 - Delete 57
 - Dialog 66
 - Edit 57
 - Moving 56
 - Saving 34, 56, 118
- Weather 188
 - Showing weather details 188
- Weather routing, PredictWind 92
- Wind barbs 188
- Wind plot panel 85
- Wind plots 84
- Wireless hotspot
 - Connect and disconnect 162
- Wireless
 - Devices details 166
 - Enable or disable the internal wireless 167
 - Smartphone connection 164
 - Tablet connection 163

X

XTE limit 69

xtf format 139



B&G