

FURUNO

GPS PLOTTER/SOUNDER

Model GP-1670F/GP-1870F



OPERATOR'S MANUAL



FURUNO ELECTRIC CO., LTD.

www.furuno.com

SWIP **ECF**
(Elemental Chlorine Free)
The paper used in this manual
is elemental chlorine free.

FURUNO ELECTRIC CO., LTD.

9-52 Ashihara-cho,
Nishinomiya, 662-8580, JAPAN

• FURUNO Authorized Distributor/Dealer

All rights reserved. Printed in Japan

Pub. No. OME-44770-C

(TAHA) GP-1670F/GP-1870F

A : JUN. 2012

C : FEB. 15, 2013



* 0 0 0 1 7 6 5 9 3 1 2 *

IMPORTANT NOTICES

General

- This manual has been authored with simplified grammar, to meet the needs of international users.
- The operator of this equipment must read and follow the descriptions in this manual. Wrong operation or maintenance can cancel the warranty or cause injury.
- Do not copy any part of this manual without written permission from FURUNO.
- If this manual is lost or worn, contact your dealer about replacement.
- The contents of this manual and equipment specifications can change without notice.
- The example screens (or illustrations) shown in this manual can be different from the screens you see on your display. The screens you see depend on your system configuration and equipment settings.
- Save this manual for future reference.
- Any modification of the equipment (including software) by persons not authorized by FURUNO will cancel the warranty.
- SDHC is a registered trademark of SD-3C, LLC.
- All brand and product names are trademarks, registered trademarks or service marks of their respective holders.

How to discard this product

Discard this product according to local regulations for the disposal of industrial waste. For disposal in the USA, see the homepage of the Electronics Industries Alliance (<http://www.eia.org>) for the correct method of disposal.

How to discard a used battery

Some FURUNO products have a battery(ies). To see if your product has a battery, see the chapter on Maintenance. Follow the instructions below if a battery is used. Tape the + and - terminals of battery before disposal to prevent fire, heat generation caused by short circuit.

In the European Union

The crossed-out trash can symbol indicates that all types of batteries must not be discarded in standard trash, or at a trash site. Take the used batteries to a battery collection site according to your national legislation and the Batteries Directive 2006/66/EU.

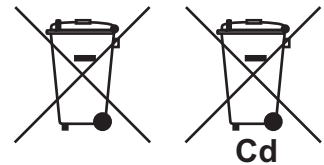

In the USA

The Mobius loop symbol (three chasing arrows) indicates that Ni-Cd and lead-acid rechargeable batteries must be recycled. Take the used batteries to a battery collection site according to local laws.

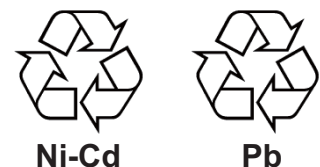

In the other countries

There are no international standards for the battery recycle symbol. The number of symbols can increase when the other countries make their own recycle symbols in the future.



SAFETY INSTRUCTIONS

The operator must read the safety instructions before attempting to operate the equipment.



WARNING

Indicates a potentially hazardous situation which, if not avoided, could result in death or serious injury.



CAUTION

Indicates a potentially hazardous situation which, if not avoided, could result in minor or moderate injury.



Warning, Caution



Prohibitive Action



Mandatory Action



WARNING



Do not open the equipment.

The equipment uses high voltage that can cause electrical shock. Refer any repair work to a qualified technician.



If water leaks into the equipment or something is dropped into the equipment, immediately turn off the power at the switchboard.

Fire or electrical shock can result.



If the equipment is giving off smoke or fire, immediately turn off the power at the switchboard.

Fire or electrical shock can result.



If you feel the equipment is acting abnormally or giving off strange noises, immediately turn off the power at the switchboard and contact a FURUNO service technician.



Electrical current flows to the pins of the transducer connector when the power is on, regardless of whether the transducer cable is connected or not.

If the transducer cable is not connected, cover the transducer connector with the supplied cap to prevent electrical shock.



WARNING



Do not disassemble or modify the equipment.

Fire, electrical shock or serious injury can result.



Make sure no rain or water splash leaks into the equipment.

Fire or electrical shock can result if water leaks into the equipment.



Do not place liquid-filled containers on or near the equipment.

Fire or electrical shock can result if a liquid spills into the equipment.



Do not operate the equipment with wet hands.

Electrical shock can result.



Use the proper fuse.

Use of the wrong fuse can cause fire or electrical shock.

⚠ CAUTION		
⊘	Do not turn on the equipment with the transducer out of water.	
	The transducer can be damaged.	
⚠	The picture is not refreshed when picture advancement is stopped.	
	Maneuvering the vessel in this condition can result in a dangerous situation.	
⚠	Adjust the gain correctly.	
	Incorrect gain may give a wrong depth indication, which could result in a dangerous situation.	
!	The data presented by this equipment is intended as a source of navigation information.	
	The prudent navigator never relies exclusively on any one source of navigation information for safety of vessel and crew.	
!	The LCD panel is made of glass. Handle it with care.	
	Injury can result if the glass breaks.	
!	Follow the compass safe distances shown below to prevent interference to a magnetic compass.	
		Standard compass
		Steering compass
GP-1670F	0.30 m	0.30 m
GP-1870F	0.30 m	0.30 m

Warning Label

Do not remove the label.

⚠ WARNING 警告 ⚠
To avoid electrical shock, do not remove cover. No user-serviceable parts inside.
感電の恐れあり。 サービスマン以外の方はカバーを開けないで下さい。 内部には高電圧部分が多くあり、万一さわると危険です。

Warning Label

TABLE OF CONTENTS

FOREWORD	ix
SYSTEM CONFIGURATION	xi
EQUIPMENT LISTS	xii
1. OPERATIONAL OVERVIEW	1-1
1.1 Controls.....	1-1
1.1.1 Control description	1-1
1.2 RotoKey™ and Soft Controls	1-5
1.3 How to Turn the Power On or Off.....	1-6
1.4 How to Adjust the Display Brilliance.....	1-6
1.5 2D Plotter Displays.....	1-6
1.6 The Cursor	1-9
1.7 Navigation Data Boxes.....	1-10
1.7.1 How to select the data to display in a box.....	1-10
1.8 Home Screen (Display Selection)	1-11
1.8.1 How to select a display	1-11
1.8.2 How to switch the active screen.....	1-11
1.8.3 How to customize the home screen	1-12
1.8.4 Description of home screen displays	1-14
1.9 Display Range.....	1-18
1.10 Orientation Mode.....	1-18
1.11 How to Move the Chart	1-19
1.12 Menu Operation	1-20
1.13 Object Information	1-21
1.13.1 Simple information	1-21
1.13.2 Detailed information	1-21
1.14 Context-Sensitive Menus	1-22
1.15 Man Overboard (MOB).....	1-24
1.15.1 How to mark MOB position	1-24
1.15.2 How to stop navigating to a MOB mark.....	1-24
1.15.3 How to erase an MOB mark.....	1-24
1.16 How to Take a Screenshot.....	1-24
1.17 Tide Information	1-25
1.17.1 Tide height information.....	1-25
1.17.2 Tide stream information	1-26
2. TRACK	2-1
2.1 How to Show, Hide all Track	2-1
2.2 How to Stop Recording Track	2-1
2.3 How to Select Recording Method, Recording In-terval	2-1
2.4 How to Change the Color of Your Boat's Track	2-2
2.5 How to Change the Color of Your Boat's Track with Sea Surface Temperature	2-2
2.6 How to Hide, Show Track by Color	2-2
2.7 How to Delete Track by Color	2-3
2.8 How to Find Track Information	2-3
3. POINTS	3-1
3.1 What is a Point?	3-1
3.2 How to Enter a Point	3-1
3.2.1 How to enter a point at the current position	3-1
3.2.2 How to enter a point at the cursor position.....	3-2

3.2.3	How to enter a position manually on the plotter screen	3-3
3.2.4	How to enter a point from the Points List	3-3
3.3	How to Find Detailed Point Information	3-4
3.4	How to Move a Point	3-4
3.4.1	How to move a point on the screen	3-4
3.4.2	How to move a point from the Points List	3-4
3.5	How to Select Visibility for Points	3-5
3.6	How to Search, Sort Points on the Points List	3-5
3.6.1	How to search points	3-5
3.6.2	How to sort points	3-5
3.7	How to Filter Points by Shape on the Points List	3-6
3.8	How to Delete Points	3-6
3.8.1	How to delete a point from the screen	3-6
3.8.2	How to delete points from the Points List	3-6
4.	ROUTES	4-1
4.1	What is a Route?	4-1
4.2	How to Create a Route	4-1
4.2.1	How to create a route from the RotoKey menu	4-1
4.2.2	How to create a route from the Routes List	4-2
4.2.3	How to create a route with the Easy Routing feature	4-3
4.3	How to Extend a Route on the Screen	4-6
4.4	How to Insert a Point on a Route on the Screen	4-7
4.5	How to Move a Point in a Route on the Screen	4-7
4.6	How to Delete a Point From a Route on the Screen	4-7
4.7	Routes List	4-8
4.7.1	How to display the Routes List	4-8
4.7.2	Functions available in the Routes List	4-9
4.8	Route Report, Route Calculator	4-10
4.9	How to Display a Route on the Screen	4-11
4.10	How to Connect Two Routes	4-11
4.11	Simple Route Information	4-11
4.12	How to Rename a Route on the Screen	4-12
4.13	How to Delete Routes	4-12
4.13.1	How to delete a route on the screen	4-12
4.13.2	How to delete routes from the Routes List	4-12
5.	NAVIGATION	5-1
5.1	How to Navigate to a Quick Point	5-1
5.2	How to Navigate to a Saved Point	5-2
5.2.1	How to navigate to a saved point selected on the screen	5-2
5.2.2	How to navigate to a point selected from the Points List	5-2
5.3	How to Select a Route for Navigation	5-2
5.3.1	On-screen route	5-2
5.3.2	Route selected from the Routes List	5-3
5.3.3	How to start navigation from a point on a route	5-3
5.4	Functions Available When You Follow a Route	5-4
5.4.1	Restart navigation	5-4
5.4.2	Follow a route in reverse order	5-4
5.4.3	Stop following a route	5-4
5.4.4	Skip a leg in a route	5-4
6.	MAP SETTINGS, 2D PERSPECTIVE/3D DISPLAYS AND SATELLITE OVERLAY	6-1
6.1	Map Setup	6-1
6.2	2D Perspective Display	6-5

TABLE OF CONTENTS

6.3	3D Display	6-6
6.3.1	3D display description	6-6
6.3.2	How to tilt and rotate the 3D display	6-7
6.3.3	How to make the 3D view clearer	6-7
6.4	Satellite Photo Overlay.....	6-8
7.	FISH FINDER OPERATIONS	7-1
7.1	How the Fish Finder Works.....	7-1
7.2	Fish Finder Display	7-2
7.3	How to Activate the Fish Finder	7-3
7.4	How to Select a Display	7-3
7.4.1	How to select a single frequency or dual frequency.....	7-3
7.4.2	How to select a zoom display.....	7-4
7.4.3	A-scope display.....	7-5
7.4.4	Bottom discrimination display.....	7-6
7.5	Automatic Fish Finder	7-8
7.5.1	How the automatic fish finder works	7-8
7.5.2	How to select an automatic fish finder mode	7-8
7.5.3	How to adjust the gain in the auto mode.....	7-8
7.6	Manual Fish Finder Operation.....	7-9
7.6.1	How to select a display range	7-9
7.6.2	How to shift the range	7-9
7.6.3	How to adjust the gain.....	7-10
7.6.4	How to reduce clutter	7-10
7.7	Picture Advance Speed.....	7-11
7.8	How to Reduce Interference	7-12
7.9	How to Erase Weak Echoes	7-12
7.10	How to Measure Depth, Time Between Locations.....	7-13
7.11	How to Balance Echo Strength.....	7-13
7.12	White Marker.....	7-14
7.13	White Line.....	7-14
7.14	Alarms	7-14
7.14.1	How to set an alarm	7-15
7.14.2	How to select the echo signal level that triggers the fish alarm	7-15
7.15	ACCU-FISH™	7-16
7.15.1	Considerations for ACCU-FISH™	7-16
7.15.2	How to activate ACCU-FISH™, select display information	7-17
7.15.3	Fish size correction	7-17
7.16	Water Temperature Graph	7-18
7.17	FISH FINDER Menu.....	7-19
7.18	Interpreting the Display	7-22
8.	ALARMS	8-1
8.1	ALARMS Menu	8-1
8.2	Audio Alarm Conditions.....	8-2
8.3	Arrival Alarm.....	8-2
8.4	XTE Alarm.....	8-3
8.5	Temperature Alarm	8-3
8.6	Shear Alarm	8-4
8.7	Depth Alarm	8-4
8.8	Anchor Alarm	8-5
8.9	Trip Alarm.....	8-5
8.10	Speed Alarm	8-5
8.11	Fuel Tank Alarm.....	8-6
8.12	Water Tank Alarm	8-6
8.13	Black Water Tank Alarm	8-6

9. MEMORY CARD OPERATIONS	9-1
9.1 The Memory Card Screen	9-1
9.2 How to Initialize SD Cards	9-1
9.3 How to Eject an SD Card.....	9-2
9.4 How to Save Data to an SD Card.....	9-2
9.5 How to Rename Files on an SD Card	9-2
9.6 How to Delete Files from an SD Card	9-3
9.6.1 How to delete individual files from an SD card	9-3
9.6.2 How to delete all files from an SD card	9-3
9.7 How to Import Data from an SD Card.....	9-3
9.8 How to Process Screenshots	9-4
9.8.1 How to select source of screenshots (internal memory or SD card)	9-4
9.8.2 How to save screenshots in the internal memory to an SD card.....	9-4
9.8.3 How to delete screenshots	9-5
10. OTHER FUNCTIONS	10-1
10.1 AIS Operations	10-1
10.1.1 AIS target symbols	10-1
10.1.2 How to find AIS target information.....	10-2
10.1.3 AIS activation range	10-2
10.1.4 CPA and TCPA alarms.....	10-2
10.2 DSC Message Information	10-3
10.2.1 How to select a device for DSC message information	10-3
10.2.2 DSC message information	10-3
10.3 Stopwatch, Timer.....	10-4
10.4 How to Select Input, Output Data	10-5
10.4.1 Input data	10-5
10.4.2 Output data.....	10-6
10.5 Engine Display Setup (INSTRUMENTS menu).....	10-7
11. CUSTOMIZING YOUR UNIT	11-1
11.1 GENERAL Menu	11-1
11.2 PLOTTER Menu.....	11-2
11.3 SYSTEM Menu.....	11-3
12. MAINTENANCE, TROUBLESHOOTING	12-1
12.1 Maintenance	12-1
12.2 How to Replace the Fuse	12-2
12.3 Troubleshooting.....	12-2
12.4 GPS Status Display	12-4
12.5 How to Restore Defaults, Clear Memory	12-5
12.6 System Information.....	12-6
13. INSTALLATION	13-1
13.1 Installation of Display Unit	13-1
13.2 Installation of Antenna Unit.....	13-2
13.3 Installation of Transducers	13-2
13.3.1 How to mount a transducer through the hull	13-2
13.3.2 Transom mount transducer	13-5
13.3.3 How to mount a transducer inside the hull	13-6
13.3.4 Triducer	13-7
13.4 Installation of Sensors (option).....	13-12
13.4.1 Speed/temperature sensors ST-02MSB, ST-02PSB	13-12
13.4.2 Temperature sensors	13-13
13.5 Wiring	13-15
13.6 Initial Settings	13-19

TABLE OF CONTENTS

13.6.1 INSTALLATION SETTINGS menu..... 13-19
13.6.2 CAN bus input/output..... 13-21

APPENDIX 1 MENU TREEAP-1
APPENDIX 2 ABBREVIATIONS, SYMBOLSAP-6
APPENDIX 3 JIS CABLE GUIDEAP-11
SPECIFICATIONSSP-1
PACKING LISTS..... A-1
OUTLINE DRAWINGS..... D-1
INTERCONNECTION DIAGRAM S-1
INDEX.....IN-1

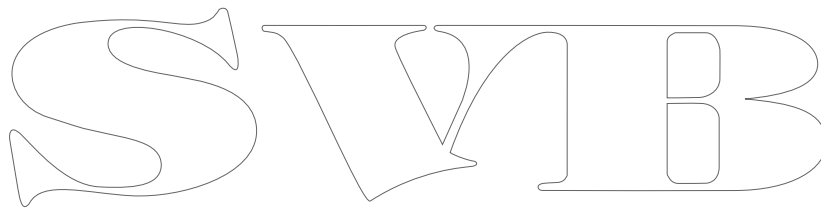

FOREWORD

A Word to GP-1670F, GP-1870F Owners

Congratulations on your choice of the FURUNO GP-1670F, GP-1870F GPS Plotter/Sounder. We are confident you will see why the FURUNO name has become synonymous with quality and reliability.

Since 1948, FURUNO Electric Company has enjoyed an enviable reputation for innovative and dependable marine electronics equipment. This dedication to excellence is furthered by our extensive global network of agents and dealers.

This equipment is designed and constructed to meet the rigorous demands of the marine environment. However, no machine can perform its intended function unless operated and maintained properly. Please carefully read and follow the recommended procedures for operation and maintenance.

We would appreciate hearing from you, the end user, about whether we are achieving our purposes.

Thank you for considering and purchasing FURUNO equipment.

Features

The GP-1670F and GP-1870F provide a totally integrated GPS receiver, color video plotter and color fish finder. The built-in GPS receiver provides highly accurate position, course and speed information. The fish finder presents vivid underwater images on a high quality LCD. The compact display unit and antenna unit permit installation where space is limited.

The main features are

General

- Bright 5.7-inch (GP-1670F) or 7-inch (GP-1870F) color LCD with brilliance control.
- Excellent viewing angles, even when wearing sunglasses.
- Internal GPS receiver provides highly accurate position information (GPS, within 2.5 m, SBAS, within 2 m).
- Customizable analog and digital displays show wind angle and speed, engine condition (speed, temperature, oil pressure, etc.), etc.
- Large internal memory stores 30,000 track points, 30,000 points, 1,000 routes (500 waypoints/route).
- SD card slot accepts SD and SDHC cards for external storage of data and settings.
- Full range of alarms: Arrival, Anchor Watch, Cross-track Error, Speed, Depth, Temperature, Fish Alarm, Bottom Alarm, etc.
- Man overboard (MOB) feature records latitude and longitude coordinates at the time of MOB.
- CAN bus interface for the connection of GPS Receiver, Weather Station, FI-50 (instrument series), Satellite Compass, etc.
- Accepts NMEA0183 input with optional NMEA data converter.
- Internal GPS antenna available.
- C-Map 4D charts available.

Fish finder

- Fish finder measures the depth to the bottom and displays underwater conditions in multi-colors* according to echo strength. A monochrome presentation shows the echoes in shades of gray. (*Number of colors depends on network sounder, color sounder.).
- Automatic and manual fish finder operation. Auto mode automatically adjusts range, gain and clutter according to purpose - fishing or cruising.
- Wide variety of zoom modes for detailed observation of fish and bottom.
- ACCU-FISH™ provides length and depth of individual fish. Appropriate transducer required.

Other

- AIS function (requires connection to an AIS transponder) provides navigational information from AIS transponder equipped vessels within 50 nm.
- Instrument displays (steering, engine, weather, and wind) with connection of relevant sensors.
- DSC (Digital Selective Calling) function alerts to DSC messages received and position requests. (Requires DSC capable radiotelephone.)

Open Source Acknowledgement

This product makes use of the following open source software:

- FreeType (www.freetype.org)
Portions of this software are copyright ©2009 The FreeType Project (www.freetype.org). All rights reserved.
- libpng (<http://www.libpng.org/>)
This software is based in part on the work of the Independent JPEG Group.
- libjpeg (<http://www.iijg.org/>)
We would like to thank each developer of the above-mentioned open source software for their great contribution to the open source community.

SYSTEM CONFIGURATION

The environmental category of each unit is as follows:

Unit	Environmental category
Display unit	Protected from the weather
GPS antenna unit	Exposed to the weather, or protected from the weather in case of internal antenna
Transducer, sensor	Submerged in water
Other units	Protected from the weather

GP-1670F

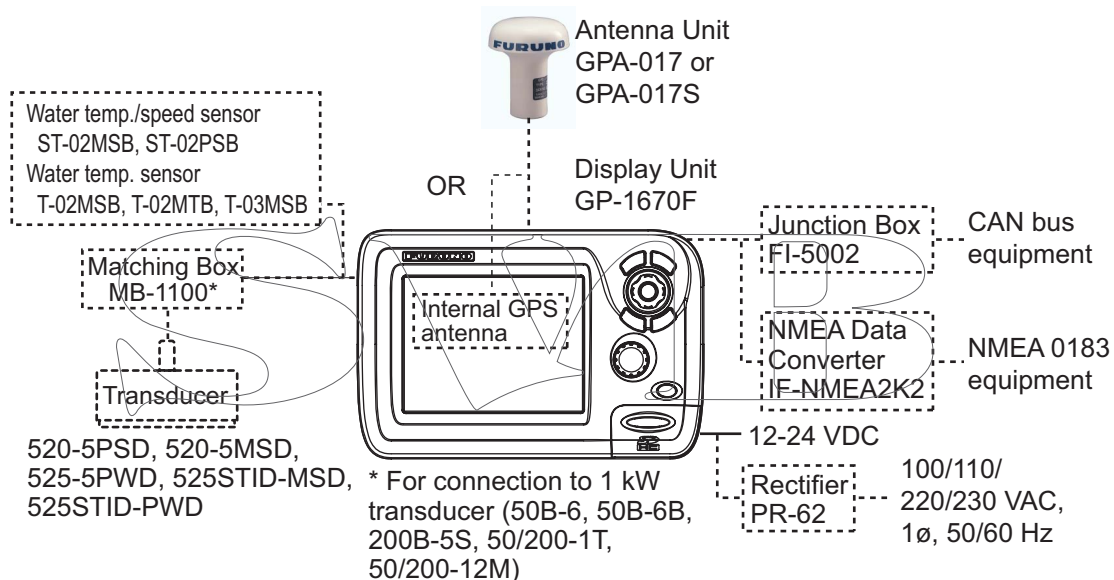

GP-1870F

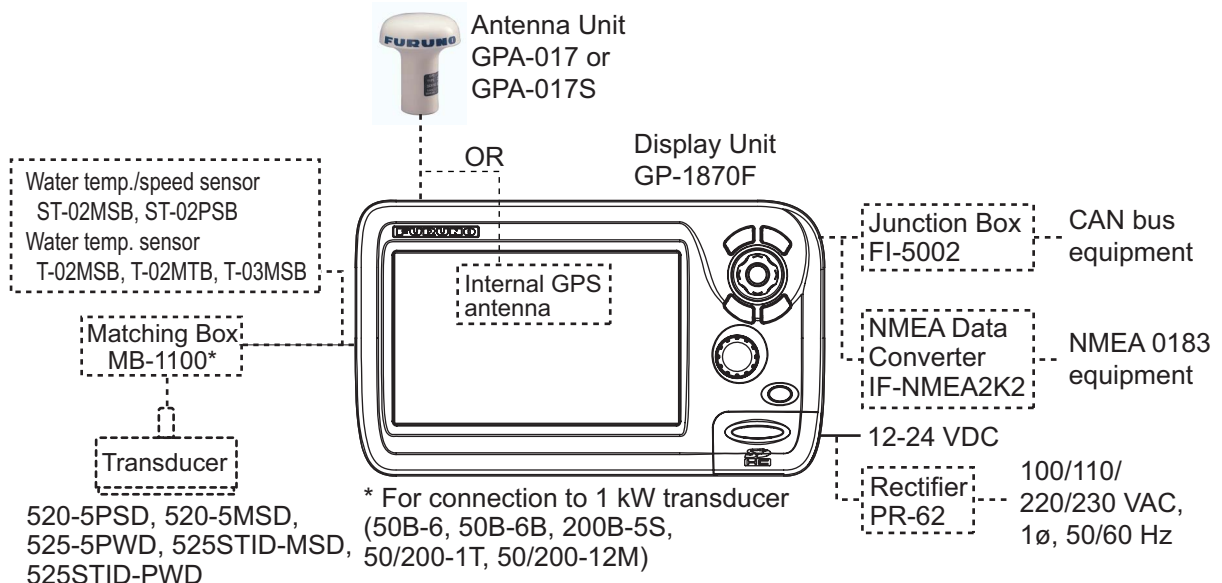

EQUIPMENT LISTS

Standard supply

Name	Type	Code no.	Qty	Remarks
Display Unit	GP-1670F	-	Select one	
Display Unit	GP-1870F	-		
Installation Materials	CP14-07100	000-021-070	1 set	w/CP14-07101, MJ-A3SPF0013A-035C (power cable)
Spare Parts	SP14-03501	001-184-710	1 set	
Accessories	FP14-03001	001-184-730	1 set	For GP-1670F
	FP14-03201	001-183-120	1 set	For GP-1870F

Optional equipment

Name	Type	Code no.	Remarks
Replacement Kit	OP14-72	001-184-750	
Waterproofing Cap	LTWCAP-WBDMMSA1	000-167-169-11	
Antenna Unit	GPA-017		
Antenna Unit	GPA-017S		
Mast Mtg. Kit	CP20-01111	004-365-780	
Antenna Cable Set	CP20-01700 *30M*	004-372-110	
Antenna Cable Set	CP20-01710 *50M*	004-372-120	
Transducer	520-5PSD	000-015-204	Thru-hull mount, plastic
	520-5MSD	000-015-212	Thru-hull mount, metal
	525-5PWD	000-146-966-01	Transom mount, plastic
Triducer (transducer with speed/ temperature sensor)	525STID-MSD	000-011-783	Thru-hull mount, metal
	525STID-PWD	000-011-784	Transom mount, plastic
Transducer (1 Kw)	50B-6	000-015-042	10 m, 1 kW
	50B-6B	000-015-043	15 m, 1 kW
	200B-5S	000-015-029	10 m, 1 kW
	50/200-1T	000-015-170	10 m, 1 kW
	50/200-12M	000-015-171	10 m, 1 kW
Speed/ Temperature Sensor	ST-02MSB	000-137-986-01	Thru-hull type, metal
	ST-02PSB	000-137-987-01	Thru-hull type, plastic

Name	Type	Code no.	Remarks
Temperature Sensor	T-02MTB	000-040-026	Transom mount, 8 m cable
	T-02MSB	000-040-040	Thru-hull type
	T-03MSB	000-040-027	Thru-hull type, 8 m cable
Matching Box	MB-1100	000-041-353	For connection to 1 kW transducer
Rectifier	PR-62	000-013-484	100 VAC
Rectifier	PR-62	000-013-485	110 VAC
Rectifier	PR-62	000-013-486	220 VAC
Rectifier	PR-62	000-013-487	230 VAC
Junction Box	FI-5002		
Right Angle Mounting Base	No.13QA330	001-111-910-10	
L-angle Mounting Base	No.13-QA310	001-111-900-10	
Handrail Mounting Base	No.13-RC5160	001-111-920-10	
Cable Assy.	TNC-PS-/PS-3D-L15M-R	001-173-110-10	
Cable Assy.	M12-05BM+05BF-010	001-105-750-10	w/connectors (light), 1 m
Cable Assy.	M12-05BM+05BF-020	001-105-760-10	w/connectors (light), 2 m
Cable Assy.	M12-05BM+05BF-060	001-105-770-10	w/connectors (light), 6 m
Cable Assy.	M12-05BFFM-010	001-105-780-10	w/connectors (light), 1 m
Cable Assy.	M12-05BFFM-020	001-105-790-10	w/connectors (light), 2 m
Cable Assy.	M12-05BFFM-060	001-105-800-10	w/connectors (light), 6 m
Cable Assy.	CB-05PM+05BF-010	000-167-968-10	w/connectors (heavy), 1 m
Cable Assy.	CB-05PM+05BF-020	000-167-969-10	w/connectors (heavy), 2 m
Cable Assy.	CB-05PM+05BF-060	000-167-970-10	w/connectors (heavy), 6 m
Cable Assy.	CB-05BFFM-010	000-167-971-10	w/connectors (heavy), 1 m
Cable Assy.	CB-05BFFM-020	000-167-972-10	w/connectors (heavy), 2 m
Cable Assy.	CB-05BFFM-060	000-167-973-10	w/connectors (heavy), 6 m
Micro T-connector	SS-050505-FMF-TS001	000-168-603-10	Micro style: 3
Mini/Micro T-connector	NC-050505-FMF-TS001	000-160-507-10	Mini style: 2, micro style: 1
Termination Resistor (Mini)	LTWMN-05AMMT-SL8001	000-160-508-10	Mini style, male, termination resistor
Termination Resistor (Micro)	LTWMC-05BMMT-SL8001	000-168-604-10	Micro style, male, termination resistor

EQUIPMENT LISTS

Name	Type	Code no.	Remarks
Termination Resistor (Mini)	LTWMN-05AFFT-SL8001	000-160-509-10	Mini style, female, termination resistor
Termination Resistor (Micro)	LTWMC-05BFFT-SL8001	000-168-605-10	Micro style, female, termination resistor
Inline Terminator	FRU-0505-FF-IS	001-077-830-10	
Cable Assy.	02S4147-1	000-141-082	For speed/temp. sensor
Inner Hull Kit	22S0191	000-082-598	w/installation instructions, not usable with the bottom discrimination display
NMEA Data Converter	IF-NMEA2K2		

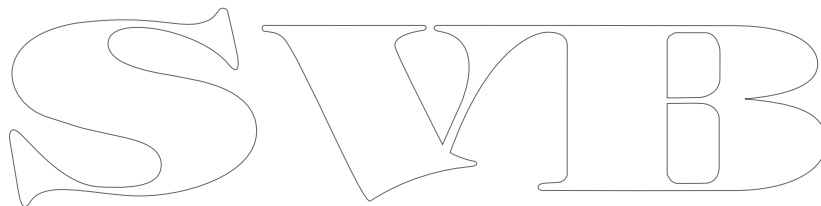
The image shows a large, stylized outline logo for 'SVIB'. The letters are bold and have a decorative, slightly irregular font style. The 'S' is on the left, followed by 'V', 'I', and 'B' on the right. The entire logo is rendered in a simple black outline.

1. OPERATIONAL OVERVIEW

1.1 Controls

1.1.1 Control description

The controller for this system is either the GP-1670F or the GP-1870F. A key that has two text labels has two functions. The top label is the main function and the bottom label is the secondary function. Short-push to access the main function and long-push (approximately three seconds) to access the secondary function.

You operate the chart plotter with

- Keys
- CursorPad
- RotoKey™
- Menus, where you select options
- Context-sensitive menus, where you select options
- Lists, where you can edit items

When you operate a key, a single beep sounds to tell you correct operation. If you do not need the key beep, you can deactivate it from the menu.

How to remove the hard cover

Put fingers under notch at bottom of cover and pull toward you.

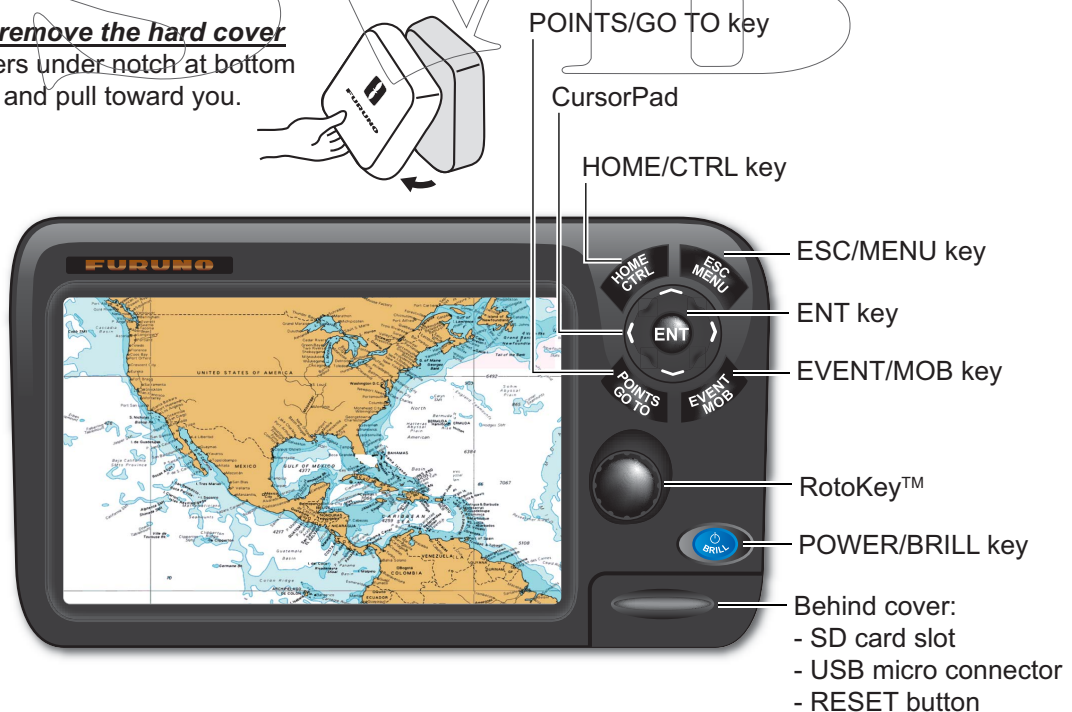

Pictured: GP-1870F

Control	Description
POWER/BRILL key	Short press: Adjust LCD brilliance. Long press: Turn the power on or off.

1. OPERATIONAL OVERVIEW

Control	Description
RotoKey™	<p>Short push: Display the base RotoKey soft controls for the current mode.</p> <p>Long push: Display the full RotoKey soft controls for the current mode.</p> <p>Rotate: Zoom in or out the display range for the chart. Select a menu item. Select the display range for the fish finder.</p>
POINTS/GO TO key	<p>Short press: Put a point at the cursor position.</p> <p>Long press: Set cursor position as destination.</p>
EVENT/MOB key	<p>Short press: Put a point at the current position.</p> <p>Long press: Put an MOB (ManOverBoard) mark at current position.</p>
ENT key	Confirm current operation.
ESC/MENU key	<p>Short press: Escape from current operation. Silence an audio alarm.</p> <p>Long press: Open the menu.</p>
HOME/CTRL key	<p>Short press: Display the home screen, to select a display.</p> <p>Long press: Switch the active display in combination modes.</p>
CursorPad	Moves the cursor and scrolls the screen, in the direction of the arrow pressed.
<p>SD card slot: Card drive for SD card (chart card and memory card).</p> <p>Micro USB connector: Connects to a PC for maintenance. (Mouse or USB flash memory cannot be connected.)</p> <p>RESET button: Resets the program. Should the screen freeze press this button to re-start.</p>	

SD cards

The SD cards store ship's tracks, routes, points, settings, etc. The unit accepts SD and SDHC (Secure Digital High Capacity) type cards and the maximum capacity is 32 GB.



To set a card in the slot, insert the card label side up. If the card does not go in easily, do not use force. Push the card until the card is in position.

To remove a card, Select [Eject SD card] from the full RotoKey menu. Remove the card (with your fingers) after the message "You can eject SD card safely." appears.

Care and handling of SD cards

- Handle the cards carefully; rough handling can damage the card and destroy its contents.
- **Make sure the cover is closed at all times.** Insert the card fully or remove the card; the cover cannot be closed if the card is inserted partially.
- Remove a card with only your fingers. Do not use metal instruments (like tweezers) to remove the card.
- Do not remove a card during the reading of the card or writing to the card, to prevent damage to the card and loss of the data stored on the card.
- If water is at the bottom of the cover, DO NOT open the cover. Remove the water with a dry cloth completely and then open the cover.

Tested SD cards

The SD cards tested for use in this equipment are listed in the table below.

Maker, Type	Size				
	2 GB	4 GB	8 GB	16 GB	32 GB
ADTEC					
AD-SDH (SD) [AD-SDH2G]	Y				
BUFFALO					
RSDC-S (SD) [RSDC-S2G]	Y				
RSDC-G Hi-Performance (SD) [RSDC-G2G]	Y				
Hagiwara System					
T series (SD) [PSDB0487A]	Y				
M series Super High Speed (SD) [PSDB0486A]	Y				
I-O DATA					
I-O DATA (SD) [SD-2G]	Y				
I-O DATA Super High Speed (SD) [SDP-2G]	Y				
Kingston					
Kingston (SD) [SD/2GBFE]	Y				
Kingston (SDHC) CLASS 4 [SD4/16GB]				Y	
Kingston (SDHC) CLASS 4 [SD4/32GB]					Y
Panasonic					
Panasonic PRO HIGH SPEED (SD) [RP-SDK02GJ1A]	Y				
Panasonic HIGH SPEED (SD) CLASS 2 [[RP-SDR02GJ1A]	Y				
Panasonic HIGH SPEED (SDHC) CLASS 4 [RP-SDM04GK1K]		Y			
Panasonic HIGH SPEED (SDHC) CLASS 4 [RP-SDM08GK1K]			Y		
Panasonic HIGH SPEED (SDHC) CLASS 4 [RP-SDM16GK1K]				Y	
Panasonic (SDHC) CLASS 4 [RP-SDP16GJ1K]				Y	
Panasonic (SDHC) CLASS 10 [RP-SDW16GJ1K]				Y	
Panasonic PRO HIGH SPEED (SDHC) CLASS 6 [RP-SDV04GK1K]		Y			
Panasonic PRO HIGH SPEED (SDHC) CLASS 6 [RP-SDV08GK1K]			Y		
pqi					
pqi (SD) [QSDS-2G]	Y				

1. OPERATIONAL OVERVIEW

Maker, Type	Size				
	2 GB	4 GB	8GB	16 GB	32GB
San Disk					
SanDisk (SD) [SDSDB-2048-J60]	Y				
SanDisk (SDHC) [SDSDBR-4096-J85]		Y			
SanDisk Ultra II (SDHC) CLASS 4 [SDSDRH-8192-903]			Y		
SanDisk Ultra II (SD) [SDSDH-2048-903]	Y				
SanDisk Ultra II (SDHC) [SDSDRH-4096-903]		Y			
SanDisk Extreme III (SDHC) [SDSDRX3-4096-903]		Y			
SanDisk Extreme (SDHC) [SDSDX3-016G-J31A]				Y	
SanDisk Extreme (SDHC) [SDSDX3-032G-J31A]					Y
SILICON POWER					
(SDHC) [SP016GBSDH006V10]				Y	
(SDHC) [SP032GBSDH006V10]					Y
TOSHIBA					
(SD) CLASS 4 [SD-B002GT4]	Y				

SVIB

1.2 RotoKey™ and Soft Controls

The main function of the **RotoKey™** is to display the RotoKey menu, a set of revolving soft controls that change with the operating mode. There are two sets of RotoKey menus: base and full. A short push of the key shows the base set for the current mode, and a long push displays the full compliment of soft controls for the current mode. When the full set is active, a scroll bar appears to show your location in the menu.

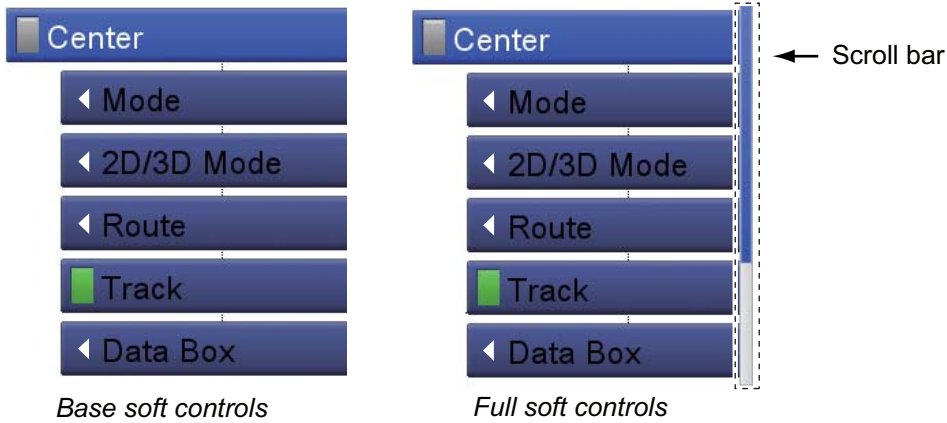

There are two categories of soft controls, toggle and drop-down list. Category is distinguished by an icon at the left edge of the soft controls.

Soft control category	Example	Description
Toggle		A soft control with a lamp is a toggle control . The lamp is green when the function is ON; gray when OFF.
Drop-down list		A soft control with a left arrow has a drop-down list that has a set of functions to choose from.

To operate the soft controls, push the **RotoKey™** to show the RotoKey menu. Rotate the key to select a soft control then push the key to do the function labeled on the soft control. When you search through the RotoKey menu, the selected soft control is longer than other soft controls, its color is light blue and the soft control name is in white characters. The soft controls automatically disappear from the screen if not operated within approx. six seconds. To erase the soft controls manually, press the **ESC/MENU** key.

Note 1: Hereafter, this manual only implies the use of the **RotoKey™** in soft control operations. We write “Open the RotoKey menu then select [soft control name]” where you would rotate and push the key to select and do a function.

Note 2: Where “key” is not preceded by a key name, this means the **RotoKey™**.

1.3 How to Turn the Power On or Off

To turn the power ON, press  approx two seconds. Release when the FURUNO logo appears. It takes approx. 25-30 seconds to start the system, in the sequence shown below.

- 1) If some data is missing or is out of date, a message states the missing component. Contact your dealer for details.
- 2) If a C-MAP chart card is inserted, chart information is checked to see if it is up to date. If the chart is not up to date, the message "The chart data is out of data, and may be unsafe for navigation, which could place you and others at risk..." If this message appears contact your dealer to get up-to-date charts.
- 3) The unit beeps and shows the "Warnings - Limitations on Use" screen. Read the information then push the **RotoKey™** to start operation.

To turn the power OFF, press  until the message "Shutting down, please wait..." appears.

1.4 How to Adjust the Display Brilliance

You can adjust the display brilliance as follows:

1. Press the  key to show the [Backlight Brill] adjustment window.
2. Press the same key again to adjust the brilliance cyclically. The window shows the current level with analog and digital displays. The brilliance can also be adjusted with the **RotoKey™**. Rotate the key clockwise to increase the brilliance, or counterclockwise to decrease the brilliance.
3. Press the **ESC/MENU** key to close the window.

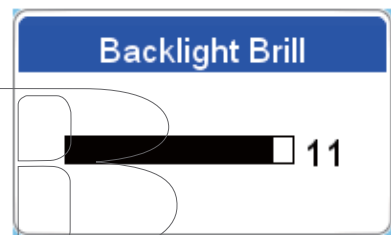

1.5 2D Plotter Displays

The plotter provides a small world map. More detailed charts for your area are optionally available. The plotter section has functions to enter waypoints, and create and plan routes.

The plotter receives position information from the internal GPS receiver. Your position is marked on the screen with the own ship icon. You can change the shape of the icon from the menu. Waypoints and routes you have entered are shown on the display. You can move, delete and edit the waypoints and routes from a context-sensitive menu or through the menu.

The plotter display also

- Plots the track of your boat.
- Measures distances and bearings.
- Marks man overboard (MOB) position.
- Controls alarm functions.
- Follows routes.

2D plotter display, vector chart

A vector chart is a series of points and lines that make up the features on a chart. Vector charts look computer generated. Details on the chart can be turned on and off. Objects on the chart can be clicked on to learn more details. Depths can be monitored to warn before grounding. When zooming in and out of a vector chart only the geographical features grow larger or smaller where text keeps it's same size and orientation. Vector charts lack most topographical features.

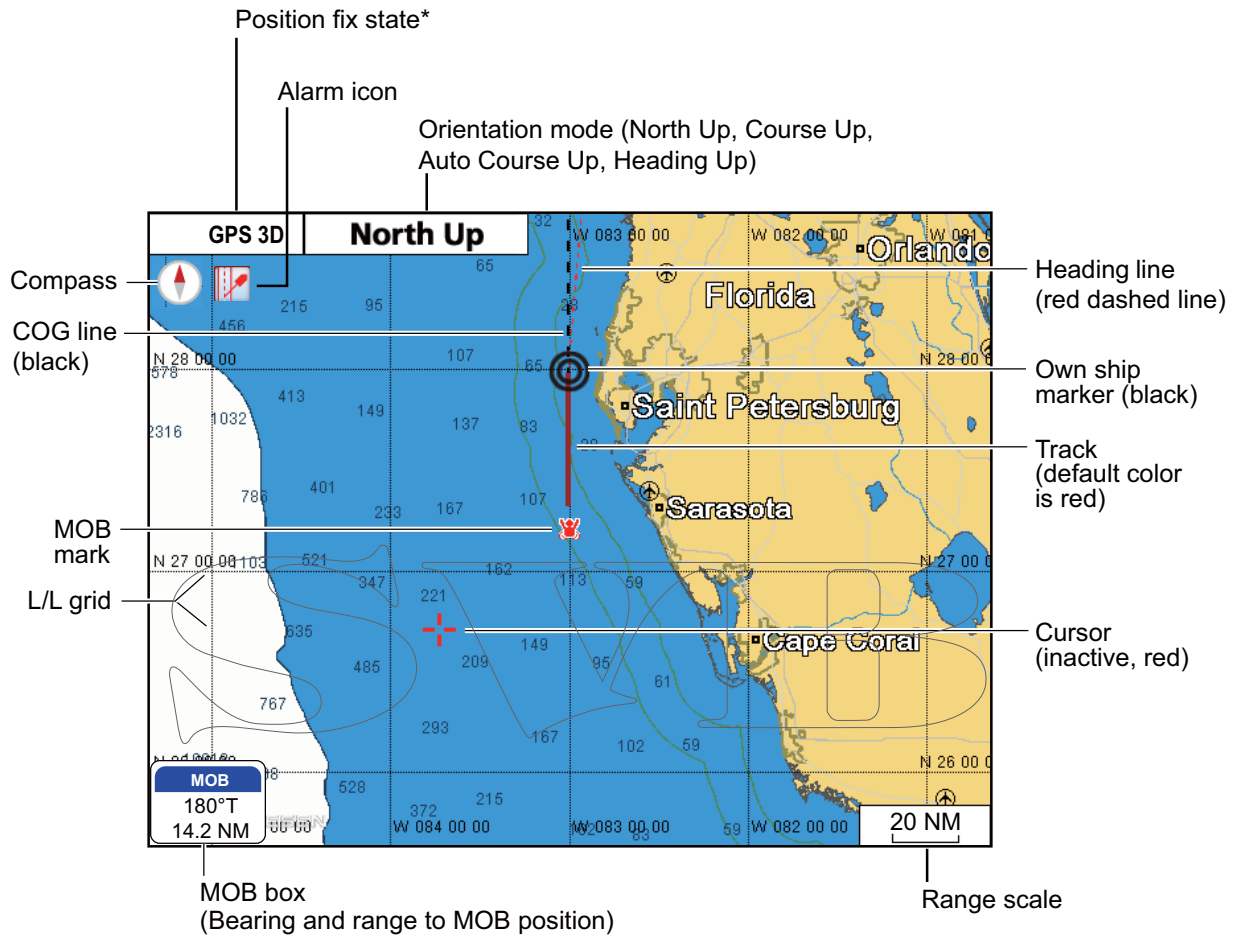

*Position fix state indications

- GPS 2D: 2D position fix
- GPS 3D: 3D position fix
- GPSW2D: WAAS 2D position fix
- GPSW3D: WAAS 3D position fix
- NO FIX: No position data
- SIM: Simulator mode

1. OPERATIONAL OVERVIEW

2D plotter display, vector/satellite

The vector chart plus a satellite photo. See chapter 6 for how to adjust the satellite display.



2D plotter display, raster

A raster chart is a direct copy or scan of an existing paper chart. Raster charts look identical to paper charts. All information contained within the chart is printed directly on it. What you see is what you get. When zooming in and out of a raster chart everything on the chart grows larger or smaller. When rotating a raster chart everything on the chart rotates.

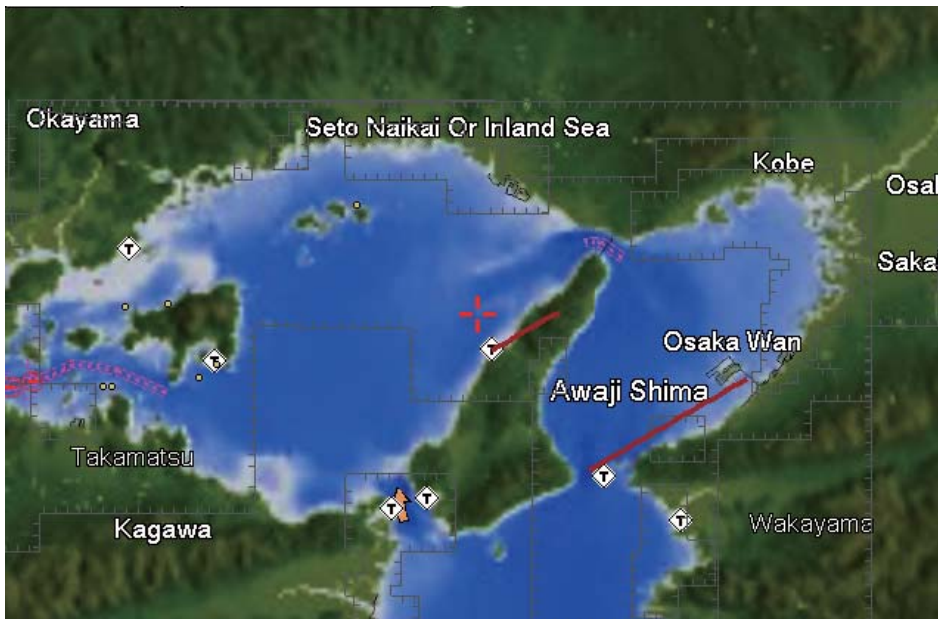

1.6 The Cursor

The cursor has the functions shown below.

- Find, when put on respective item:
 - Position, range and bearing to cursor location
 - Point information
 - Route information
 - Track information
 - AIS target information
 - DSC information
 - Tide information
 - Object information
- Select a position for a waypoint on the plotter display.
- Select an item. For example, a waypoint on the plotter display.

The appearance of the cursor depends on its state - active or inactive.

To move the cursor, press any of the four arrows on the **CursorPad**. The cursor moves in the direction indicated on the pressed arrow.

 : Active  : Inactive (red)

How to find cursor position, range and bearing to cursor position

Press any of the four arrows on the **CursorPad** to move the cursor in the direction indicated on the pressed arrow. The cursor position and the distance and bearing from your boat to the cursor position are displayed.

Position	
43°59.2157'N	
135°16.6498'E	
DST NM	BRG T
10.5	185°

Cursor position in latitude and longitude

Distance to cursor position

Bearing to cursor position

How to find current position, SOG and COG

Put the cursor on the own ship icon to find current position, SOG and COG.

Position	
43°22.1834'N	
134°26.3465'E	
SOG kn	COG T
12.2	155°

Cursor position in latitude and longitude

Speed over the ground

Course over the ground

1.7 Navigation Data Boxes

The navigation data boxes, displayed at the bottom of the screen, show various navigation data fed from the sensors connected to the display unit. Two or four boxes can be displayed and you can freely change the data shown in each box. The data that you can show depends on your system configuration. The boxes can be shown or hidden with the [Nav Data] soft control.

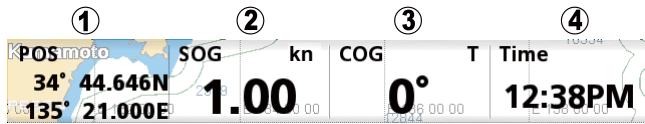

Note: Waypoint name, distance to WPT, bearing to WPT, XTE, TTG and ETA are not available unless you are navigating to a point or route. Bars (--) are shown in the respective box when the data is not available.

1.7.1 How to select the data to display in a box

1. Open the full RotoKey menu then choose [Select Data]. The background color of all but one of the boxes is grey.

Box not greyed out is currently selected box.

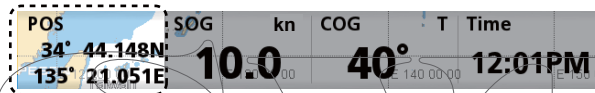

2. Rotate the **RotoKey™** to select the data box to change then push the key to show the [Select Data] (data category) window.

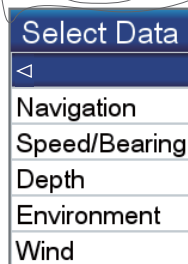

3. Select a data box category, and a window with choices relevant to your selection appears.

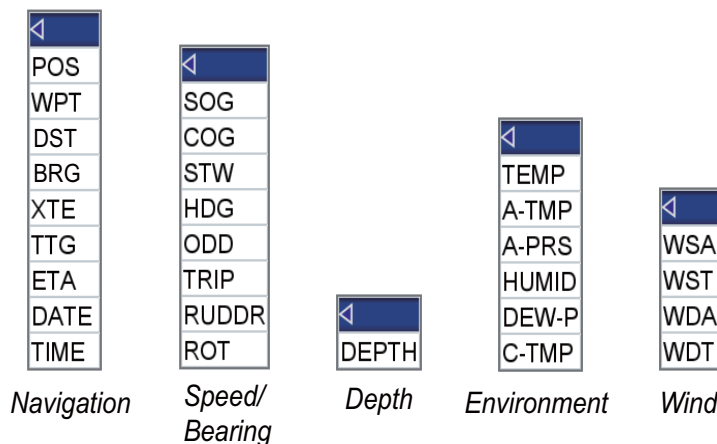

4. Select the data desired.

1.8 Home Screen (Display Selection)

1.8.1 How to select a display

The home screen has eight displays from which to choose. Press the **HOME/CTRL** key to show the home screen. Operate the **CursorPad** or rotate the **RotoKey™** to select a display. The current selection is circumscribed with a red rectangle. Press the **RotoKey™** or **ENT** key to confirm your selection.

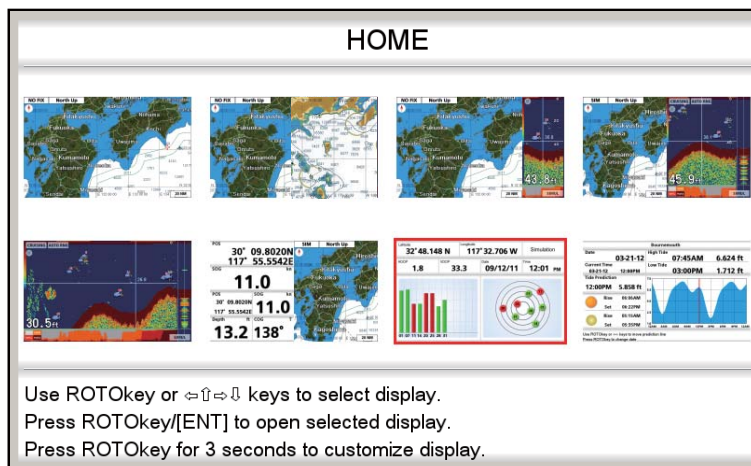

1.8.2 How to switch the active screen

In multi-split screens, you can switch the active screen with the **HOME/CTRL** key. Long-press the key to select the screen to make active. The active screen is circumscribed with a red rectangle.

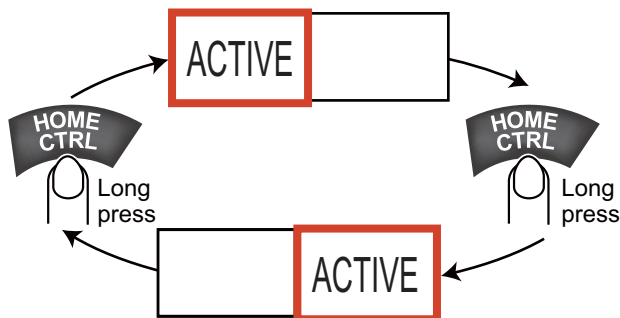

1.8.3 How to customize the home screen

The home screen has seven screens that you can customize. (The full-screen plotter display cannot be customized. If you try to customize this display, the message “Can’t customize this display.” appears.) You can split the screen in up to four separate segments. In each segment you can select the following displays:

Screen	Displays available
Single screen	Plotter, fish finder, tide and celestial, GPS status
Half screen	Plotter, fish finder, highway, wind angle meter, meter (speed, water temperature/temperature, engine), graph, tank
Quarter screen	Navigation data, steering, wind angle meter, meter (same choices as for half screen), graph, tank

Follow the procedure below to customize a home screen. As an example, the procedure shows how to put the plotter display and fish finder display on the halves screen.

1. Press the **HOME/CTRL** key to show the home screen.
2. Use the **RotoKey™** to select the screen to customize.
3. Long-push the **RotoKey™** to show the [PAGE CUSTOMIZATION] screen.

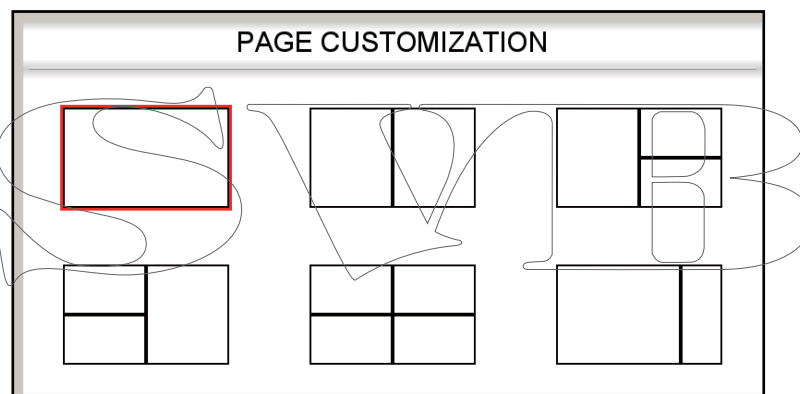

4. Select the division desired then push the **RotoKey™**. For example, select the halves screen. The [DISPLAY CUSTOMIZATION] screen appears.

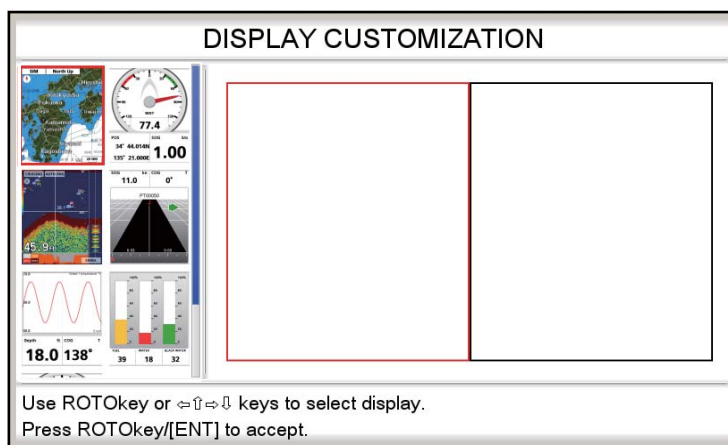

The rectangle cursor (red) in the screen selection area circumscribes the screen division currently selected. If necessary, use the **RotoKey™** to select a screen division.

5. Select a display then push the **RotoKey™**. For example, select the plotter display. The chosen display appears at the location selected and the rectangle cursor moves to the adjacent screen.

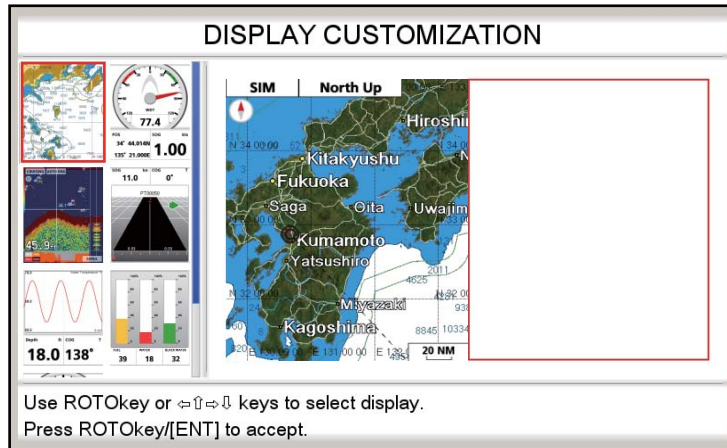

6. Select a display for the right half then push the **RotoKey™**. For example, select the fish finder display. Control is returned to the home screen, where you can see the result of your selection.

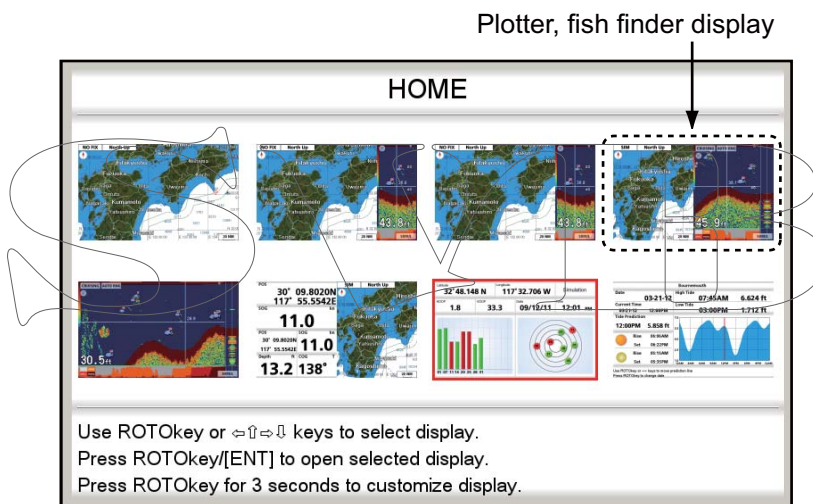

1.8.4 Description of home screen displays

Full screen displays

Plotter: See page 1-7.

Fish finder: See chapter 7.

Tide & Celestial: Your plotter provides for calculation of the tide heights for any date. Additionally this display shows the time of sunrise, sunset, moonrise and moonset. See section 1.17.

GPS status display: The GPS status display shows the location and RX signal strength of each satellite being received. See section 12.4.

Half screen displays

The half screen displays provide the plotter display, highway display, navigation data, and navigation data plus a graphic display (graph or meter). In most displays the data can be changed. See the end of this section for how to change data.

Plotter: See page 1-7.

Highway: The highway display provides a graphic presentation of your boat's track along intended course, and is useful for monitoring ship's progress toward a waypoint. You can zoom in and zoom out the display by rotating the **RotoKey™**. The vertical line at the center of the screen is your intended course and the name of the waypoint you are steering to is at top of the line. Steer your boat so that the own ship marker in the XTE scale stays near zero. If you go off course, the direction to steer to return to your course is indicated with the color-coded steer direction arrow. The arrow is red when you should steer to port; green when you should steer to starboard. The width of the navigation lane (black area in the figure below) and the XTE (cross-track error) range scale are equal to the XTE alarm setting. In the example illustration, the boat is off course to the starboard side by approx 0.3 nm. Rotate the **RotoKey™** to change the display range.

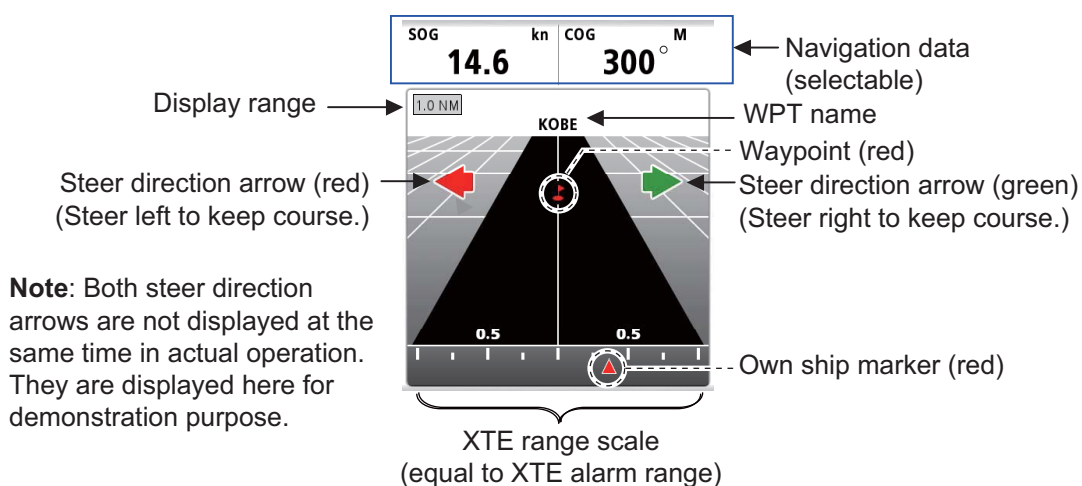

Wind meter+navigation data x2: The wind meter provides analog and digital indications of wind angle. The wind meter is fixed; however, the two boxes of navigation data can be changed.

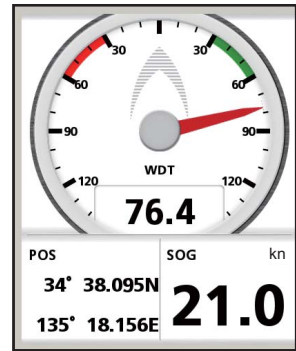

Meter+navigation data x2: This display provides a meter plus two navigation data boxes. The meter and boxes can be changed. The example at right shows the appearance of the SOG meter.

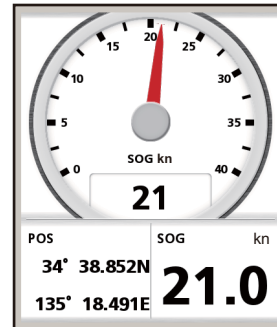

Graph+navigation data x2: The graph (depth, water temperature, air temperature, atmospheric pressure, SOG, wind speed) plots selected data in a five-minute period. The navigation data indications can be changed freely.

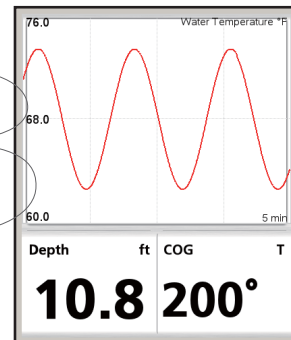
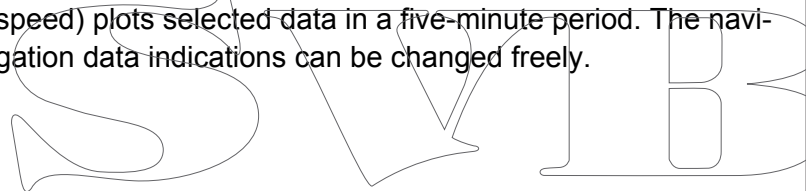

Tank level: The tank level of fuel, water and black water are shown in both analog and digital formats. The analog indication is colored according to tank level as follows:

Color	Tank level	
	Fuel, water	Black water
Green	Equal to or greater than 40%	Equal to or less than 60%
Yellow	Between 20% and 39%	Between 61% and 80%
Red	Less than 20%	Greater than 80%

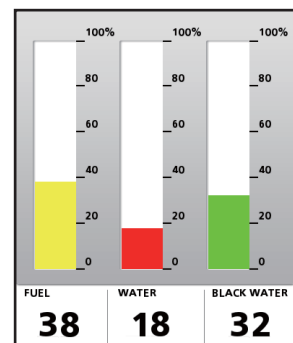

1. OPERATIONAL OVERVIEW

Quarter screens

The figure below shows the available quarter screens. Like with the half screens you can select the navigation data to display in a quarter screen.



Navigation data x1

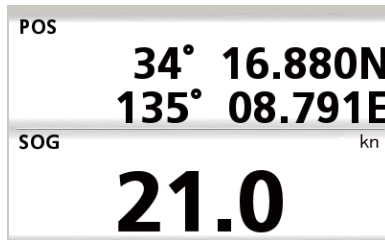

Navigation data x2

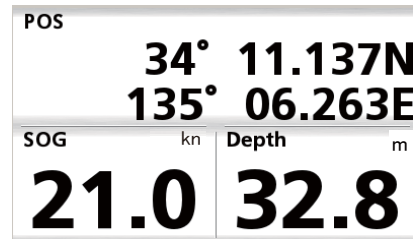

Navigation data x3



Navigation data x4

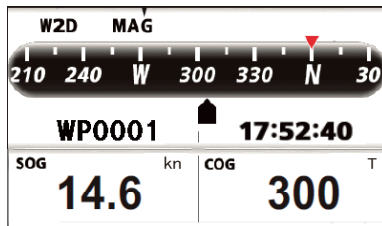

Steering



Wind angle



Meter x1 (ex. SOG)

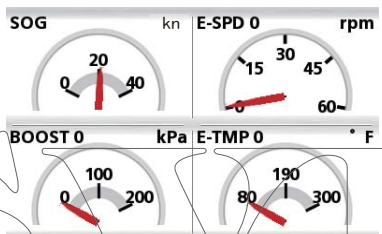

Meter x4

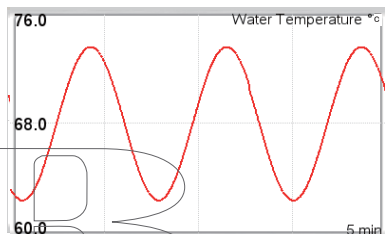

Graph

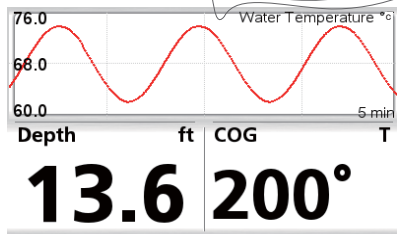

Graph, navigation data x2

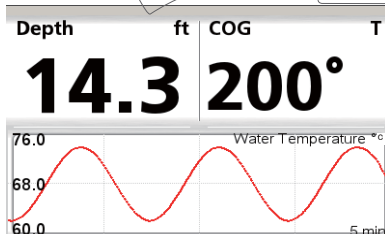

Navigation data x2, graph

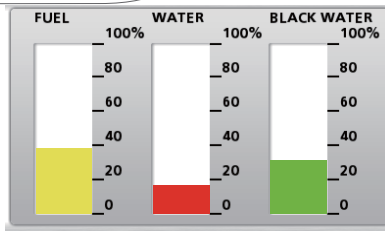

Tank

How to select the data to display in a quarter screen, half screen navigation data

1. Display a home screen that has a quarter screen or a half screen with navigation data.
2. Long press the **HOME/CTRL** key to select the data display to change. The selected indication is circumscribed with a red rectangle.
3. Choose [Select Data] from the RotoKey menu.
4. Rotate the **RotoKey™** to select the indication to change then push the **RotoKey™**. The [Select Data] window shows the data categories available.
5. Rotate the **RotoKey™** to select a category then push the key. The right figure shows the choices available with [Navigation].
6. Select desired data.

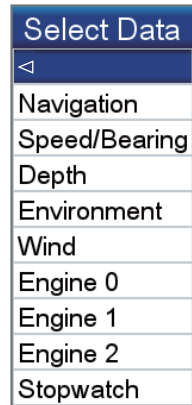

Engine indications

The following engine indications are available, in the quarter screen.

- Engine boost pressure
- Engine coolant pressure
- Engine load
- Engine oil pressure
- Engine oil temperature
- Engine speed
- Engine temperature
- Engine trim
- Fuel pressure
- Fuel rate
- Total engine hours
- Transmission oil pressure
- Transmission temperature

Engine instance number

The engine instance number appears on all engine-related indications.

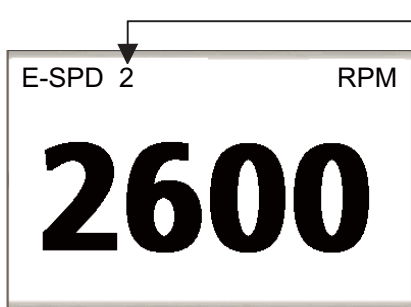

Engine Instance No.
 0: Single engine, or PORT engine with 2 or 3 engines
 1: STARBOARD engine with 2 engines, or CENTER engine with 3 engines
 2: STARBOARD engine with 3 engines

Note: This is the standard numbering method, Different methods can be applied.

1.9 Display Range

You can change the chart scale to change the amount of information shown, or zoom in or out at the location you select, in the plotter and steering displays. The selected chart scale appears at the bottom right-hand position on the screen. The available ranges depends on latitude and chart area.

To select a display range, rotate the **RotoKey™**. Clockwise to increase the range; counterclockwise to decrease the range.

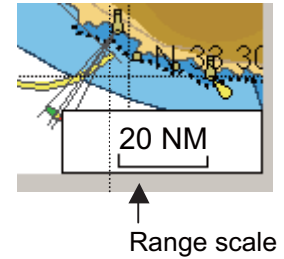

1.10 Orientation Mode

The chart can be shown in head-up, north-up, course-up and auto course-up. Select an orientation mode from the RotoKey menu: Select [Mode] followed by [Head Up], [North Up], [Course Up] or [Auto Course Up]. The selected mode appears at the top right-hand position.

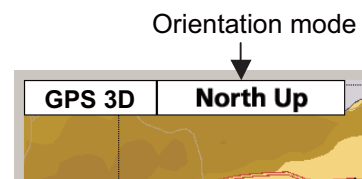

Description of orientation modes

Head-up: Displays the chart with the current compass heading of your boat at the top of the screen. The heading data from a compass is required. When the heading changes, the ship icon remains fixed, and the chart picture rotates according to heading.

North-up: North is at the top of the screen. When your heading changes, the ship icon moves according to heading. This mode is for long-range navigation.

Course-up: The chart picture is stabilized, and shown with your current course (over ground) at the top of the screen. The ship icon moves with the heading. If you select a new course, the picture resets to display the new course at the top of the screen. If no destination is set, the course is upward on the screen at the moment course-up is selected.

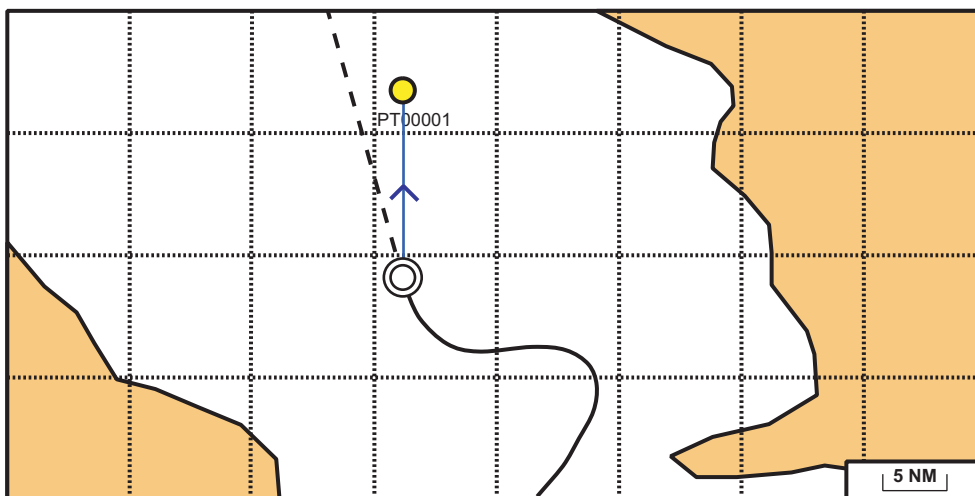

Auto course-up: The course or heading is at the top of screen at the moment the auto course-up mode is selected.

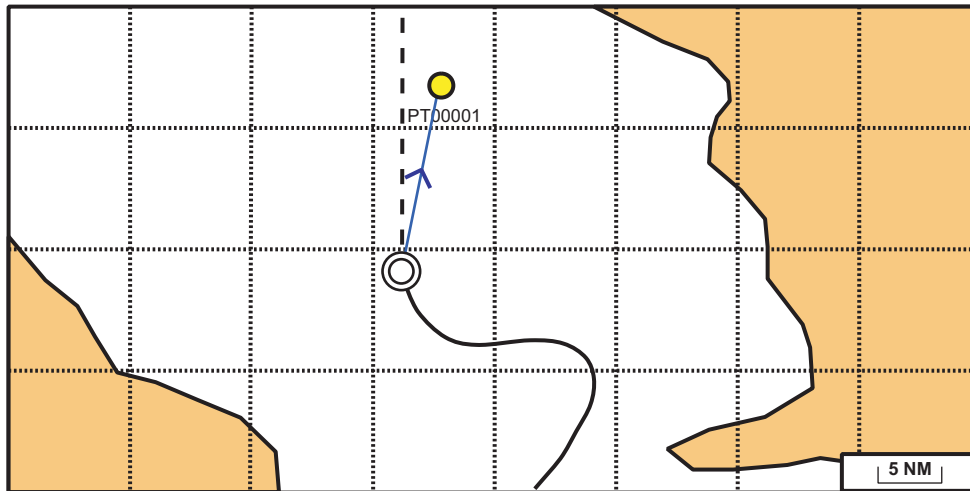

1.11 How to Move the Chart

Move the chart in the following conditions.

- Your boat is not in the current area.
- Take a look at another area.
- Enter a point at another location.

To move the chart, press and hold down the **CursorPad** to move it to an edge of the display. The chart shifts in the direction opposite to the arrow pressed.

To return your boat to the screen center, select [Center] from the RotoKey menu.

1.12 Menu Operation

This section shows you how to operate the menu. There are eight menus, [General], [Map], [Plotter], [Alarms], [System], [Fish Finder], [Instruments] and [Interface].

1. Long-push the **ESC/MENU** key to show the main menu.

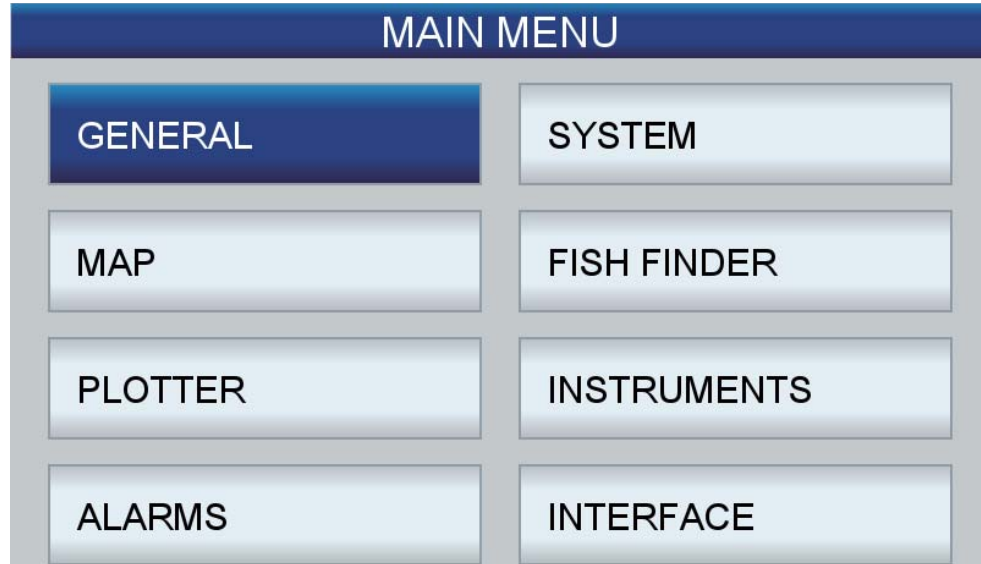

2. Rotate the **RotoKey™** to select a menu then push the key or the **ENT** key to display that menu. (A menu can also be selected with the **CursorPad**.) For example, select the [General] menu.

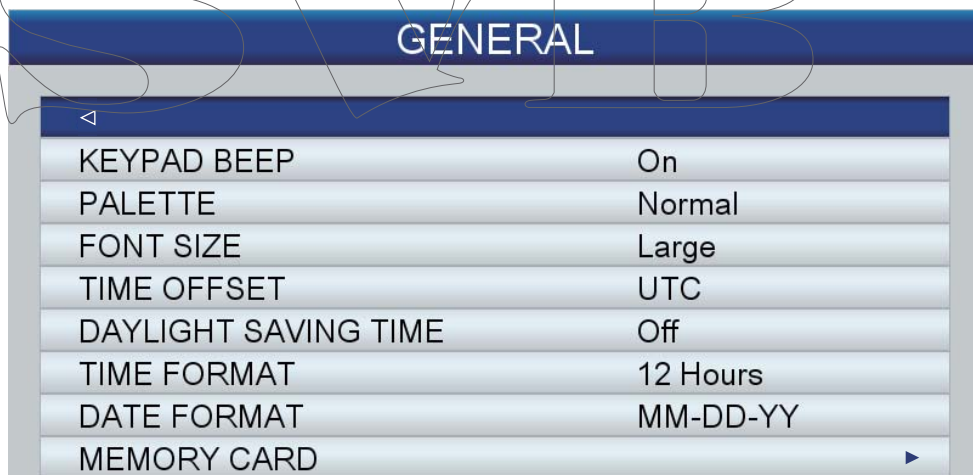

3. Rotate the **RotoKey™** to select a menu item then push the key to show the corresponding options window. For example, select [Font Size] and the options window shown right appears.

Large
Small
4. Rotate the **RotoKey™** to select an option then push the key to confirm setting. Some menu items require entry of alphanumeric data. See the procedure below.

How to enter alphanumeric data

- 1) Use the right and left arrows on the **CursorPad** to select the digit or character to change.
- 2) Use the up and down arrows on the **CursorPad** to select a numeric value.
- 3) Repeat steps 1) and 2) to enter remaining numeric data.

- 4) Press the **ENT** key to save the data.
5. Press the **ESC/MENU** key to close the menu. (Several presses may be required depending on your location in the menu.)

Note: Hereafter, this manual only implies the use of the **RotoKey™** in menu operations. We write “Select [menu name, menu item or menu option]” where you would rotate and push the key to select and set a menu item.

1.13 Object Information

1.13.1 Simple information

Simple information is available for points, track, routes, objects, AIS targets, DSC marker and tide. Simply put the cursor on the item for which you want to find information. The figure below shows simple information for a point, track, route and chart object.

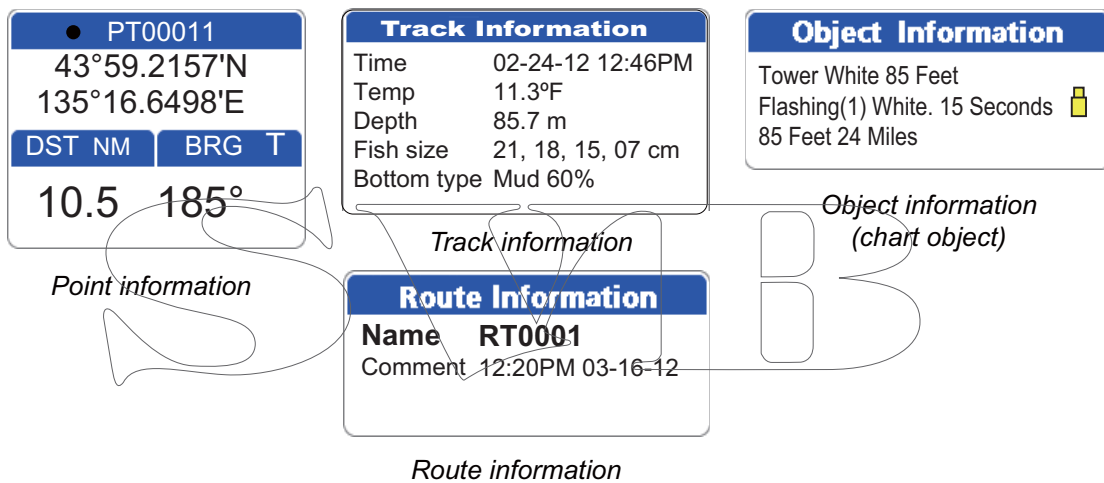

1.13.2 Detailed information

Detailed information is available for points, routes and chart objects. Put the cursor on the item for which you want to find detailed information then press the **ENT** key to show the context-sensitive menu. Select one of the following depending on your selection:

- Point: [DETAILED]
- Route: [INFO]
- Chart object: [FULL INFO]





The right figure shows detailed information for a point.





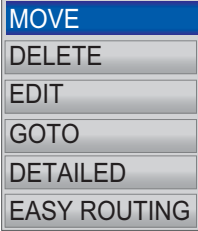

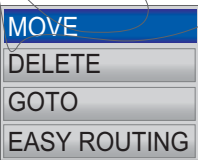
Point Information	
Name	PT0001
Position	34°41.006N 135°41.629E
Time	02-24-12 12:46PM
Temp	11.3°
Depth	85.7 m
Fish size	21, 18, 15, 07 cm
Bottom type	Mud 60%
Comment	FURUNO

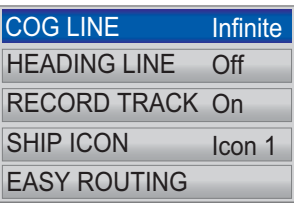
Detailed point information

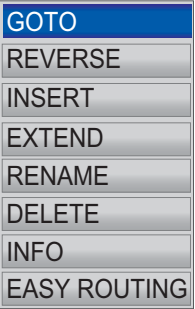
1.14 Context-Sensitive Menus

The context-sensitive menus let you quickly access the functions related to the cursor-selected item. Select an applicable item then press the **ENT** key to show the related context-sensitive menu. Use the **RotoKey™** to select a function. The table below shows the context-sensitive menus available in each category.

Item	Context-sensitive menu	Description
Point		<p>[MOVE]: Move the point selected.</p> <p>[DELETE]: Delete the point selected.</p> <p>[EDIT]: Edit the point selected.</p> <p>[GOTO]: Go to the point selected.</p> <p>[DETAILED]: Find detailed information about the point selected.</p> <p>[EASY ROUTING]: Get easy routing calculations to the point selected.</p>
Point (set as destination)		<p>[STOP]: Stop navigating to the point selected.</p> <p>[RESTART]: Restart navigation to the point selected.</p> <p>[DETAILED]: Get detailed information about the point selected.</p>
Point in Route (active route)		<p>[MOVE]: Move the point selected.</p> <p>[SKIP]: Skip the point selected.</p> <p>[ACTIVATE FROM]: Start navigating from the point selected.</p>
Point in Route (inactive route)		<p>[MOVE]: Move the point selected.</p> <p>[DELETE]: Delete the point selected.</p> <p>[GOTO]: Start navigating from the point selected.</p> <p>[EASY ROUTING]: Get easy routing calculations for the route selected.</p>
Chart Object		<p>[FULL INFO]: Get full information about the chart object selected.</p> <p>[LAT/LON]: Save the position selected as a point.</p> <p>[EASY ROUTING]: Get easy routing calculations to the chart object selected.</p>
Own Boat		<p>[COG LINE]: Show or hide the COG vector.</p> <p>[HEADING LINE]: Show or hide the heading line.</p> <p>[RECORD TRACK]: Stop or start recording your boat's track.</p> <p>[SHIP ICON]: Change the ship icon.</p> <p>[EASY ROUTING]: Get easy routing calculations.</p>

Item	Context-sensitive menu	Description
Route (active)		<p>[STOP]: Stop navigating the active route.</p> <p>[RESTART]: Restart navigating the active route.</p> <p>[REVERSE]: Follow the points in the active route in reverse order.</p> <p>[INSERT]: Add a new point to the cursor position of the active route.</p> <p>[EXTEND]: Add a new point to the end of the active route.</p> <p>[INFO]: Get information about the active route.</p>
Route (inactive)		<p>[GOTO]: Activate the route selected.</p> <p>[REVERSE]: Follow the points in the route in reverse order.</p> <p>[INSERT]: Add a new point to the cursor position of the route selected.</p> <p>[EXTEND]: Add a new point to the end of the route selected.</p> <p>[RENAME]: Rename the route selected.</p> <p>[DELETE]: Delete the route selected.</p> <p>[INFO]: Get information about the route selected.</p> <p>[EASY ROUTING]: Get easy routing calculations for the route selected.</p>
Track		<p>[HIDE]: Hide the track in the selected color.</p> <p>[DELETE]: Delete the track in the selected color.</p> <p>[EASY ROUTING]: Get easy routing calculations for the track.</p>
Points List		<p>[EDIT]: Edit the point selected.</p> <p>[DELETE]: Delete the point selected.</p> <p>[PLOT]: Show the point selected on the plotter display.</p> <p>[MODE]: Select the visibility for the point selected.</p> <p>[GOTO]: Go to the point selected.</p>
Routes List		<p>[EDIT]: Edit the route selected.</p> <p>[DELETE]: Delete the route selected.</p> <p>[PLOT]: Show the route selected on the plotter display.</p> <p>[REVERSE]: Follow the points of the route selected in reverse order.</p> <p>[REPORT]: Display the route report for the route selected.</p> <p>[GOTO]: Go to the route selected.</p>
MOB mark (on screen)		<p>[START]: Go to the MOB mark selected.</p> <p>[DELETE]: Delete the MOB mark selected.</p>
MOB mark (on Points List)		<p>[PLOT]: Show the MOB mark selected on the plotter display.</p> <p>[DELETE]: Delete the MOB mark selected.</p> <p>[GOTO]: Go to the MOB mark selected.</p>

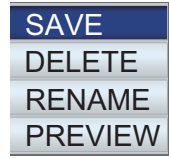
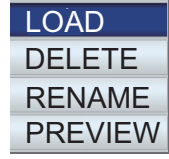
Item	Context-sensitive menu	Description
Screen-shots (INTERNAL)		<p>[SAVE]: Copy the screenshots in the internal memory to the SD card.</p> <p>[DELETE]: Delete the screenshots.</p> <p>[RENAME]: Give the file a new name.</p> <p>[PREVIEW]: Show the screenshots selected on the screen.</p>
Screen-shots (SD CARD)		<p>[LOAD]: Copy the screenshots in the SD card to the internal memory.</p> <p>[DELETE]: Delete the screenshots.</p> <p>[RENAME]: Give the file a new name.</p> <p>[PREVIEW]: Show the screenshots selected on the screen.</p>

1.15 Man Overboard (MOB)

The MOB mark denotes man overboard position. Enter the mark when someone falls overboard, to automatically create a route to the man overboard position. Only one mark can be displayed.

1.15.1 How to mark MOB position

Long-push the **EVENT/MOB** key on any screen. The plotter display appears if you are using a different screen. The MOB mark is put at the latitude and longitude position of your boat at the moment the key is pressed. The [MOB] box at the bottom left of the screen shows the bearing and range to the MOB mark.

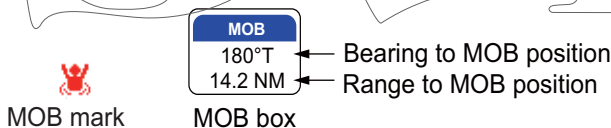

1.15.2 How to stop navigating to a MOB mark

Put the cursor on the MOB mark then press the **ENT** key. "STOP" appears at the bottom left corner. Press the **ENT** key to stop navigation. The message "Stop navigating to MOB. Are you sure?" appears. [YES] is selected; press the **ENT** key.

1.15.3 How to erase an MOB mark

Put the cursor on the mark then press the **ENT** key to show the context-sensitive menu. Select [DELETE] then press the **ENT** key. The message "Delete MOB. Are you sure?" appears. [YES] is selected; press the **ENT** key. (The MOB mark set as destination cannot be erased. You must cancel navigation to the mark before you can erase it.)

1.16 How to Take a Screenshot

You can take a screenshot at any time and save it to the internal memory, in PNG format. Open the full RotoKey menu then select [Screenshot]. For how to process screenshots, see section 9.8.

1.17 Tide Information

Your chart contains worldwide tide height and tidal current information.

1.17.1 Tide height information

The tide station symbol appears at the locations of tide height recording stations.

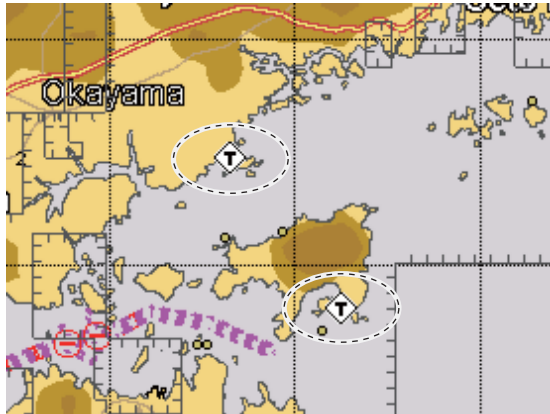

To get tide information from a tide station, put the cursor on the tide station symbol, press the **ENT** key then select [FULL INFO] from the context-sensitive menu to show the [OBJECTS] menu. The cursor is selecting [Tide height station]; push the **ENT** key to get tide height information.

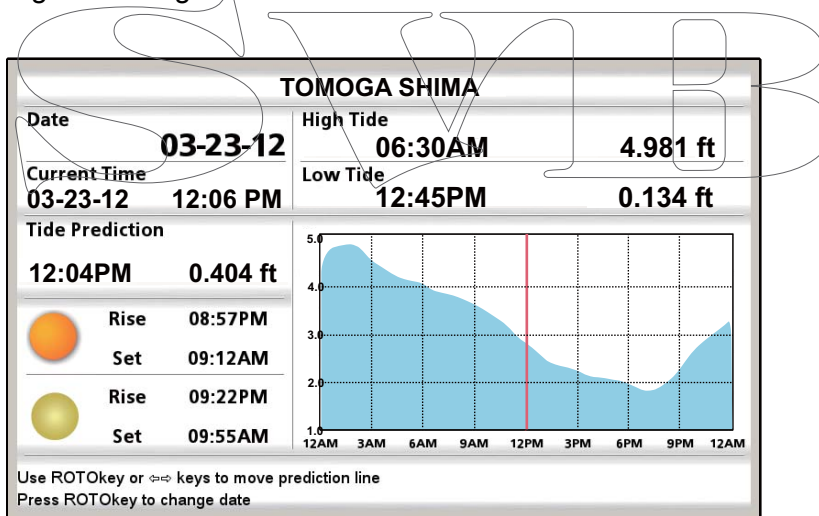

If several tide stations overlap one another on the screen, information for each station is presented when [FULL INFO] is selected from the context-sensitive menu. Select desired station to find tide information.

- The information is mostly accurate under moderate weather conditions. However, storms and weather fronts can influence forecasted tide times and heights.
- To change the [Date], push the **RotoKey™** then use the **CursorPad** to set.
- To change the [Tide Prediction] time, rotate the **RotoKey™** or operate the right and left arrows on the **CursorPad**. The vertical red line moves with knob rotation/arrow operation.
- To quit the display and return to the plotter display, press the **ESC/MENU** key.

1. OPERATIONAL OVERVIEW

1.17.2 Tide stream information Information intentionally left blank.

The tidal stream information is made from the tide stream data received from tide stream station.

Tidal streams are marked with arrows. The size and color of the arrow indicate tide stream speed, Yellow, slow; orange, medium, and red, fast.

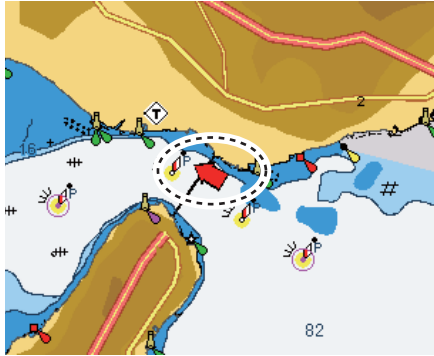

Simple and detailed tide stream information are available. For simple information, put the cursor on a tide stream marker. The [Object Information] box shows the date, time and direction and speed of the tide stream.

Object Information
23-03-12 12:03:50 PM
DIR=302°T SPD=3.7 kn

Simple tide stream information

For detailed information, press the **ENT** key then select [FULL INFO] from the context sensitive menu. [Tide stream station] is selected; see the information at the bottom of the screen.

Tide stream station
3d Height meters: 0
Name: 34°37.40'N, 135°01.73' E
Time zone: 9

2. TRACK

Your boat's track is plotted on the display with position information fed from the internal GPS navigator. This section shows you how to process track, from how to show or hide the track to how to change its color.

2.1 How to Show, Hide all Track

By soft control: Open the RotoKey menu then select [Track] to toggle the track display ON and OFF.

By context-sensitive menu: Put the cursor on any part of the track then press the **ENT** key to show the context-sensitive menu. Select [HIDE] to hide the track.

2.2 How to Stop Recording Track

1. Open the [PLOTTER] menu then select [TRACK] and [RECORD TRACK].
2. Select [Off] then press the **ENT** key.
3. Press the **ESC/MENU** key to close the menu.

To resume recording, select [On] at step 2.

2.3 How to Select Recording Method, Recording Interval

To trace your boat's track, your boat's position is stored into the memory at an interval of time or distance. For distance, a shorter interval provides better reconstruction of the track, but the storage time of the track is shorten. When the track memory becomes full, the oldest track is erased to make room for the latest.

1. Open the [PLOTTER] menu then select [TRACK] and [TRACK RECORDING METHOD].
2. Select [Time] or [Distance] as appropriate.
3. Select the menu item [Time] or [Distance] according to the item selected at step 2. The options for those menu items are shown in the right figure.
4. Select desired recording interval then press the **ESC/MENU** key to close the menu.

0.01 NM
0.05 NM
0.1 NM
0.5 NM
1.0 NM
2.0 NM
5.0 NM
10.0 NM

Distance

1 sec
5 sec
10 sec
30 sec
1 min
5 min
10 min
30 min
1h

Time

2.4 How to Change the Color of Your Boat's Track

You can select the color for your boat's track among red, green, light green, yellow, purple, orange, brown, and black. It is useful to change the color at regular intervals to distinguish tracks at different times of a day, for example.

1. Open the [PLOTTER] menu then select [TRACK] and [ACTIVE TRACK] to show the track color options.
2. Select a color then press the **ESC/MENU** key to close the menu.

2.5 How to Change the Color of Your Boat's Track with Sea Surface Temperature

You can have the track painted in a different color when the sea surface temperature changes by the amount set.

1. Open the [PLOTTER] menu then select [TRACK] and [TRACK COLOR BY TEMPERATURE].
2. Select [0.2] or [2.0] as appropriate.

0.2	2.0
Red: -1.0°F to 0.8°F, 0 to 0.2°F, 1.0°F to 1.2°F	Red: -10°F to -8.0°F, 0°C to 2.0°F, 10°F to 12°F
Orange: -0.8°F to -0.6°F, 0.2°F to 0.4°F, 1.2°F to 1.4°F	Orange: -8.0°F to -6.0°F, 2.0°F to 4.0°F, 12°F to 14°F
Yellow: -0.6°F to -0.4°F, 0.4°F to 0.6°F, 1.4°C to 1.6°F	Yellow: -6.0°F to -4.0°F, 4.0°F to 6.0°F, 14°F to 16°F
Green: -0.4°F to -0.2°F, 0.6°F to 0.8°F, 1.6°F to 1.8°F	Green: -4.0°F to -2.0°F, 6.0°F to 8.0°F, 16°F to 18°F
Blue: -0.2°F to 0°F, 0.8°F to 1.0°F, 1.8°F to 2.0°F	Blue: -2.0°F to 0°F, 8.0°F to 10°F, 18°F to 20°F

3. Press the **ESC/MENU** key to close the menu.

2.6 How to Hide, Show Track by Color

When the screen becomes cluttered with many different colors of track you may want to show only a certain color to clear up the screen.

How to show, hide track from the menu

1. Open the [PLOTTER] menu then select [TRACK] and [SHOW TRACK BY COLOR].
2. Select the color to display then press the **ENT** key.
3. Select [On]. Select [On] in [All] to display all colors.
4. Press the **ESC/MENU** key to close the menu.

How to hide track with the context-sensitive menu

Put the cursor on the track color to hide then press the **ENT** key to show the context-sensitive menu. Select [HIDE] to hide the track color selected.

2.7 How to Delete Track by Color

When the screen becomes cluttered with track, you may want to delete some track to clear up the display. You can delete track from the context-sensitive menu or the menu.

How to delete track color from the menu

1. Open the [PLOTTER] menu then select [TRACK] and [DELETE TRACK BY COLOR].
2. Select the color to delete then press the **ENT** key. The message "Delete track. Are you sure?" appears.
3. Select [YES] then press the **ENT** key.
4. Press the **ESC/MENU** key to close the menu.

How to delete track color with the context-sensitive menu

Put the cursor on the track color that you want to delete then press the **ENT** key to show the context-sensitive menu. Select [DELETE] then press the **ENT** key. The message "Delete track. Are you sure?" appears. Select [YES] then press the **ENT** key.

2.8 How to Find Track Information

Put the cursor on the track to find track information.

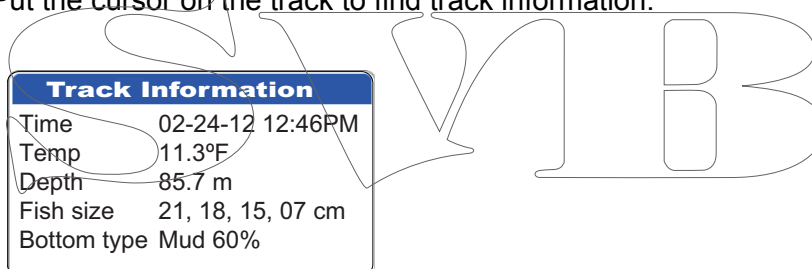

This page is intentionally left blank.

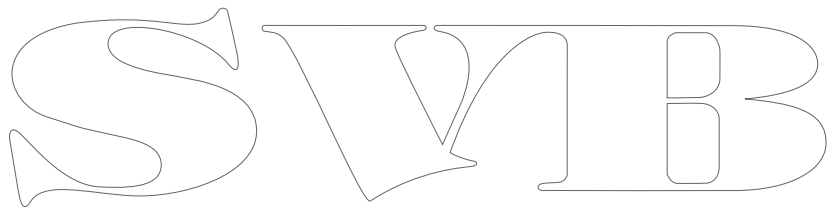
The image shows the letters 'S', 'W', 'I', and 'B' in a large, stylized, outlined font. The letters are arranged horizontally and are designed to be filled in or used as a template for coloring. The 'S' is a simple outline, while the 'W', 'I', and 'B' have more complex, decorative shapes with internal lines and curves.

3. POINTS

3.1 What is a Point?

In navigation terminology, a point is any location you mark on the plotter display. A point can be a fishing spot, reference point and other important locations. You can use a point you have entered to set a destination and create a route.

This unit has 30,000 points into which you can enter position information. There are four methods that you can use to mark a point:

- At your current position
- At cursor position
- Enter position from the [Points List]
- Enter position manually on the screen

When you enter a point, the point is put on the screen with the point symbol selected as the default point symbol, with the youngest empty point number. The position of the point, symbol and navigation information (range, bearing, etc.) are saved to the [Points List]. You can show or hide the points, and the default setting shows all points.

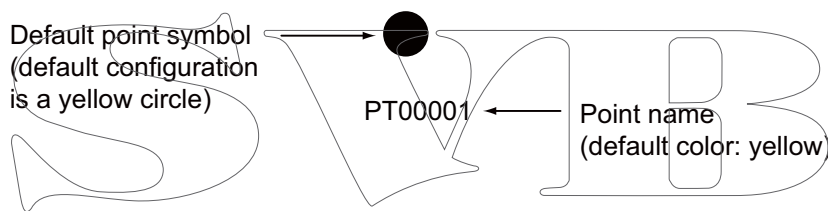

You can edit a point on the screen or on the [Points List].

3.2 How to Enter a Point

3.2.1 How to enter a point at the current position

A point may be entered at current position even when the menu is open. Press the **EVENT/MOB** key. The symbol of the point is marked at the position at the time the **EVENT/MOB** key was pressed. The point is automatically named.

3.2.2 How to enter a point at the cursor position

1. Operate the **CursorPad** to put the cursor where desired then press the **POINTS/GOTO** key.

The “point” pop-up appears and shows point name, latitude and longitude position of the point, and distance and bearing to the point. No further operation is necessary to save the point under the assigned point name and the default symbol and color. To save the point under different conditions, go to step 2.

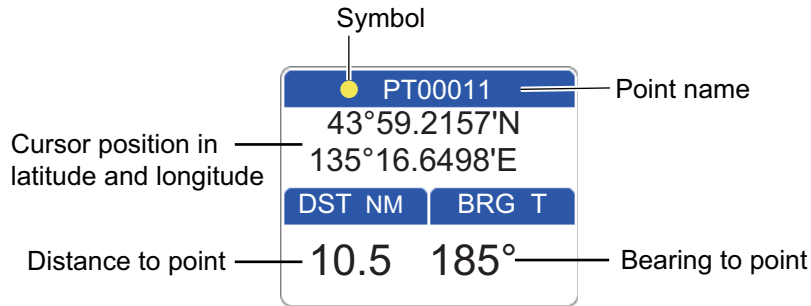

2. Press the **POINTS/GOTO** key again, and a window that looks something like the one shown below appears.

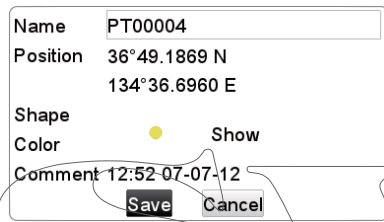

3. By default, the [Name] field shows the youngest empty point number. You can change the name, using the **CursorPad**.
4. The [Position] field shows the position at the time the point was entered. If necessary, you can change the position, using the **CursorPad**.
5. Select [Shape] to change the icon, from among the choices shown below.

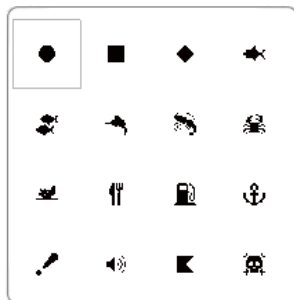

6. Select [Color] to change the color of the icon, from among the choices shown below.



7. [Show] selects the visibility level for the point (icon).
[Show]: Show the icon and the point name.

[Hide]: Hide the icon and its name.

[Icon]: Show only the icon.

8. Use [Comment] to enter a comment about the point, with the **CursorPad**. The default comment is the time and date of entry of the point. A comment may have a maximum of 64 alphanumeric characters.
9. To save the point, select the [Save] button then push the **RotoKey™** key.

3.2.3 How to enter a position manually on the plotter screen

Press the **ENT** key to show the context-sensitive menu. Select [LAT/LON] then press the **ENT** key to show the position input box. The position shown in the box is the cursor position. Enter position using the **CursorPad**. After you have entered the position, the [Save] button is automatically selected. Press the **ENT** key to save the point, under the youngest empty point number.

3.2.4 How to enter a point from the Points List

Do the following to enter a point on the [Points List].

1. Open the [PLOTTER] menu and select [POINTS] to show the [Points List].

Points List						
Name	Type	Latitude	DST NM	Mode	Comment	
		Longitude	BRG °			
PT00001	PNT	34°35.231N	15.33	Shown	12:28PM 03-16	
		135°13.592E	216			
PT00002	PNT	34°35.231N	34.68	Shown	12:28PM 03-16	
		134°45.197E	249			
PT00003	PNT	34°12.562N	41.18	Shown	12:29PM 03-16	
		134°58.365E	212			

↑ Up, ↓ Down, ⇨ Forward, ⇩ Backward

New Delete all Search Sort Icon

Rotate ROTOkey to select function, press ROTOkey to execute

2. The [New] button (at the bottom of the screen) is selected; push the **RotoKey™** to show the point entry window.

Name	PT00004
Position	36°49.1869 N 134°36.6960 E
Shape	<input type="radio"/> Show
Color	<input type="radio"/>
Comment	12:52 07-07-12
	Save Cancel

3. Follow steps 3 to 8 in section 3.2.2.
4. To save the point, select the [Save] button then push the **RotoKey™** key.

3.3 How to Find Detailed Point Information

You can find detailed point information with the point information pop-up. Put the cursor on the point then press the **ENT** key. (A point is correctly selected if the "point" box appears. See the figure in section 3.2.1.) Select [DETAILED] then press the **ENT** key.

Point Information	
Name	PT0001
Position	34°41.006N 135°41.629E
Time	02-24-12 12:46PM
Temp	11.3°
Depth	85.7 m
Fish size	21, 18, 15, 07 cm
Bottom type	Mud 60%
Comment	FURUNO

3.4 How to Move a Point

You can move a point two ways: on the screen and from the [Points List].

3.4.1 How to move a point on the screen

Method 1: Drag the point to a new location

1. Select the point with the cursor then push the **ENT** key to show the context-sensitive menu. (The point is correctly selected if the "point" box appears.)
2. Select [MOVE] from the context-sensitive menu then press the **ENT** key.
3. Drag the cursor to the new location then press the **ENT** key. The icon moves to the selected position.

Method 2: Manual input of latitude and longitude from the Points List

1. Select the point with the cursor then push the **ENT** key to show the context-sensitive menu. (The point is correctly selected if the "point" box appears.)
2. Select [EDIT] from the context-sensitive menu then press the **ENT** key to show the point edit screen.
3. Edit the position.
4. Select the [Save] button to finish.

3.4.2 How to move a point from the Points List

1. Open the [PLOTTER] menu and select [POINTS] to show the [Points List].
2. Select the point to edit.
3. Select [EDIT] from the context-sensitive menu.
4. Select the [Position] field to edit the position.
5. Select the [Save] button then press the **ENT** key.

3.5 How to Select Visibility for Points

Points can be shown or hidden individually or collectively.

1. Open the [PLOTTER] menu and select [POINTS] to show the [Points List].
2. Select the point to edit then press the **ENT** key.
Note: If you want to assign visibility globally, select any point.
3. Select [MODE] from the context-sensitive menu.

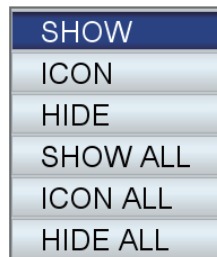

4. Select the visibility desired.
[SHOW]: Show the selected point's icon and point name.
[ICON]: Show the icon of the selected point.
[HIDE]: Hide the selected point.
[SHOW ALL]: Show all points' icon and point names.
[ICON ALL]: Show the icon of all points.
[HIDE ALL]: Hide all points.

The entry(ies) in the [Mode] column change according to your selection.

3.6 How to Search, Sort Points on the Points List

3.6.1 How to search points

1. Open the [PLOTTER] menu and select [POINTS] to show the [Points List].
2. Select [Search] (at the bottom of the screen).
3. Enter the point name in the text box. The cursor jumps to the applicable position in the [Points List].

3.6.2 How to sort points

1. Open the [PLOTTER] menu and select [POINTS] to show the [Points List].
2. Select [Sort] (at the bottom of the screen).
3. Select the sort method.
[A-Z ASCENDING]: A-to-Z order
[Z-A DESCENDING]: Z-to-A order
[DISTANCE ASCENDING]: Distance in ascending order
[DISTANCE DESCENDING]: Distance in descending order

3.7 How to Filter Points by Shape on the Points List

You may filter points on the [Points List] by icon shape. This is useful when you are looking for points of a specific shape.

1. Open the [PLOTTER] menu and select [POINTS] to show the [Points List].
2. Select [Icon] (at the bottom of the screen).
3. Select [ICON] to show the icon selection window.
4. Select the icon desired.

3.8 How to Delete Points

You can delete individual points directly on the screen and on the [Points List]. All points can be deleted from the [Points List].

3.8.1 How to delete a point from the screen

1. Select the point with the cursor then push the **ENT** key to show the context-sensitive menu. (The point is correctly selected if the "point" box appears.)
2. Select [DELETE] then press the **ENT** key. The message "Delete this point. Are you sure?" appears.
3. [YES] is selected; push the **RotoKey**TM to delete the point.

3.8.2 How to delete points from the Points List

How to delete a point

1. Open the [PLOTTER] menu and select [POINTS] to show the [Points List].
2. Select the point to delete then press the **ENT** key to show the context-sensitive menu.
3. Select [DELETE] then press the **ENT** key. The message "Delete this point. Are you sure?" appears.
4. [YES] is selected; push the **RotoKey**TM to delete the point.

How to delete all points

1. Open the [PLOTTER] menu and select [POINTS] to show the [Points List].
2. Rotate the **RotoKey**TM to select the [Delete all] button (at the bottom of the screen) then push the key. The message "Delete all points. Are you sure?" appears.
3. [YES] is selected; push the **RotoKey**TM to delete all points.

4. ROUTES

4.1 What is a Route?

Often a trip from one place to another involves several course changes, requiring a series of route points (waypoints) which you navigate to, one after another. The sequence of waypoints leading to the ultimate destination is called a route. The equipment can store 1,000 routes, with a maximum of 50 points per route.

You create a route by pointing and clicking geographical positions on the screen. These positions are marked with yellow circles.

You can follow a route that you have created, with the GOTO feature. When you follow a route, the points on the route are yellow circles and a red line with arrows connects between the points. The arrows show the direction in which to follow the route.

Routes can be edited directly on the screen or through the menu and the editing feature available depends on route status (active or inactive) and method.

- Select a route to follow.
- Select a route to follow and follow it in reverse order.
- Insert a point(s) in a route.
- Add point(s) to the end of a route.
- Rename a route.
- Delete a route.
- Find information about a route.
- Connect two routes.

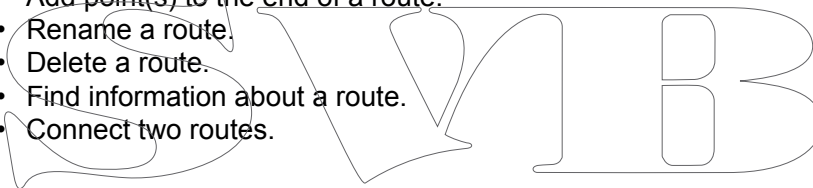

4.2 How to Create a Route

There are two ways to create a route: soft control ([Routes]→[New]) and menu ([Routes List]).

4.2.1 How to create a route from the RotoKey menu

1. Open the RotoKey menu then select [Route] and [New].
2. Put the cursor on the first point for the route then press the **ENT** key.
A yellow circle marks the position selected and the point number (QPxxxxx, xxxx=point number) appears below the point.
3. Put the cursor on the next point then press the **ENT** key.
A yellow circle marks the position and a blue line with arrow runs between the 1st point and this point. The arrow indicates the direction of the route.
Note: You can also add a saved point to the route. Select the point then press the **ENT** key.
4. Repeat step 3 to complete the route.
5. The [Save] soft control is selected; push the **RotoKey**TM to save the route.

The route is saved under the next sequential empty route number. The name for the route is initially assigned as "RTxxxx" (xxxx=route number). The name can be changed as desired.

4.2.2 How to create a route from the Routes List

A route can also be created from the [Routes List], with the points you have entered.

1. Open the [PLOTTER] menu and select [ROUTES] to show the [Routes List].

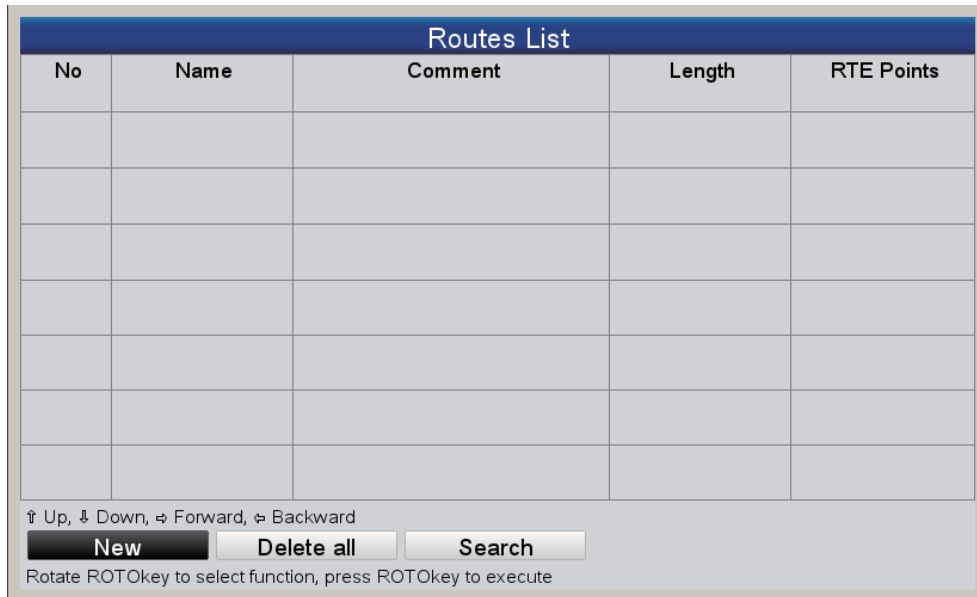

2. The [New] button is selected; push the **RotoKey™**.
3. The input box (at the bottom of the screen) is showing the route name, the youngest empty route number. Change the route name if necessary. Finally, press the **ENT** key. The screen something like the one shown below appears.

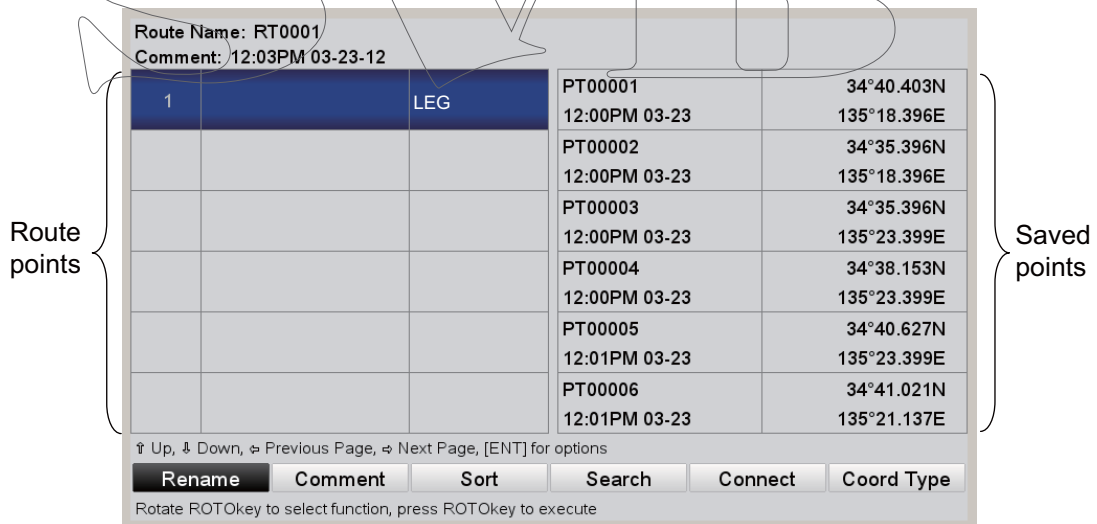

4. Press the **ENT** key to show the context-sensitive menu then do the following to enter a route point.
 - 1) [INSERT] is selected; press the **ENT** key. The cursor moves to the saved points column.
 - 2) Use the **CursorPad** to select a point then press the **ENT** key. The cursor returns to the route points column.
 - 3) Use the **CursorPad** to put the cursor on the next route point number then press the **ENT** key.
 - 4) Repeat 1) - 3) to continue entering points.

- 5) After you have entered all the points you require, press the **ESC/MENU** key. The [Routes List] reappears, showing the newly entered route.

Routes List				
No	Name	Comment	Length	RTE Points
1	RT0001	12:03PM 03-23-12	16.26 NM	6

↑ Up, ↓ Down, ⇨ Forward, ⇩ Backward

New **Delete all** **Search**

Rotate ROTOkey to select function, press ROTOkey to execute

4.2.3 How to create a route with the Easy Routing feature

The Easy Routing feature automatically constructs a route between two points, taking into consideration the preset values for safe depths, safe heights and boat's width, to provide you with an estimate of a safe route to your destination. Easy Routing can be initiated on points, on quick points, on track points, on route legs, on a position fix, on MOB position, on DSC points, on a cartographic object, and chart.

You simply set a start position and a destination. This can be newly entered points or any of the points mentioned above that are currently on the screen. (The total distance can not be longer than 100 NM.) Easy Routing then analyzes the path between the two points and creates a route, inserting legs in the route when necessary to get you away from areas which exceed the safety values set on the menu. Easy Routing analyzes each leg for safety in three levels: safe leg, potentially dangerous leg, and unsafe leg, and color codes them accordingly, green for safe, yellow for potentially dangerous and red for unsafe.

Note: A chart card must be inserted to use Easy Routing. Not all chart cards carry Easy Routing. The message "No charts with Easy Routing data found." appears if a chart card does not have Easy Routing.

EASY ROUTING DISCLAIMER: The accuracy of Easy Routing is limited by the availability of electronic charts loaded on your navigation system and the accuracy of original source material used in producing such charts. Always remember that you should navigate with the most detailed and up-to-date chart available from FURUNO, and new information from National Hydrographic Offices may render your charts obsolete at any time. Easy Routing is only an aid to navigation and must be used in conjunction with conventional navigation practices. As the navigator of your boat, you are responsible for reviewing the suggested route against the official nautical publications and situational awareness. You must edit and/or approve the suggested route before using it for navigation purposes.

How to set the safe values for Easy Routing

Follow the procedure below to set the safe values to use in Easy Routing.

1. Open the [PLOTTER] menu and select [EASY ROUTING].

EASY ROUTING	
<	
START POINT	▶
DESTINATION POINT	▶
START CALCULATIONS	
SAFE DEPTH	6.6 ft
SAFE HEIGHT	39.4 ft
SAFE CORRIDOR	0.0022 NM
TIMEOUT	5.0 min
SAFE MARGIN	On
RESPECT DRAUGHT	Off

2. [SAFE DEPTH] is the minimum safe depth, namely, your boat's draft.
3. [SAFE HEIGHT] is the minimum safe height, namely, the height of your boat.
4. [SAFE CORRIDOR] is the minimum width of the path.
5. [TIMEOUT] is the amount of time to wait before exiting the Easy Routing function, when it cannot create a route.
6. [SAFE MARGIN] is the minimum distance (300 m) between a dangerous/not navigable area and your boat. This area could be land or a body of water. Turn it on to honor this distance.
7. Turn off [RESPECT DRAUGHT] if you want to disregard the depths that are shallower than the [SAFE DEPTH] setting.

How to create a route with Easy Routing

1. Put the cursor on the starting point then press the **ENT** key.
2. Select [EASY ROUTING] followed by [START].

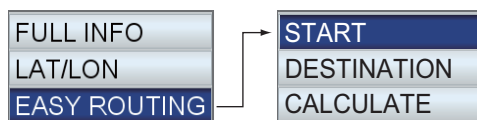

The starting point is marked with a green flag, labeled [ER START].



ER START

3. Put the cursor on the destination then press the **ENT** key.

4. Select [EASY ROUTING] followed by [DESTINATION].
The destination point is marked with a green flag, labeled [ER DEST].
5. Press the **ENT** key then select [EASY ROUTING] followed by [CALCULATE].
A warning about the use of easy routing appears. Read the warning then press the **ENT** key. Calculation begins and the right figure appears. Calculation progress is indicated with the progress bar.

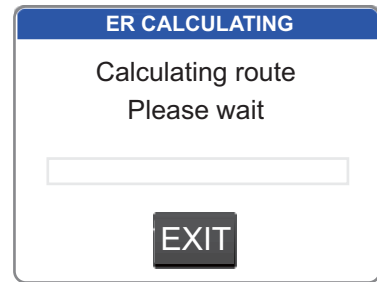

6. When the calculation is completed, the [EASY ROUTING REPORT] appears.

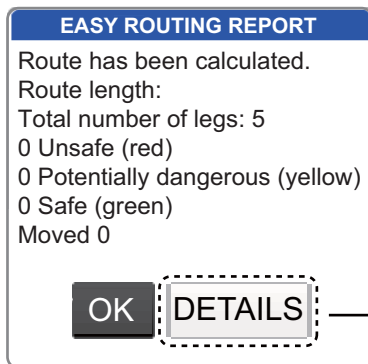

“Click” to show detailed report

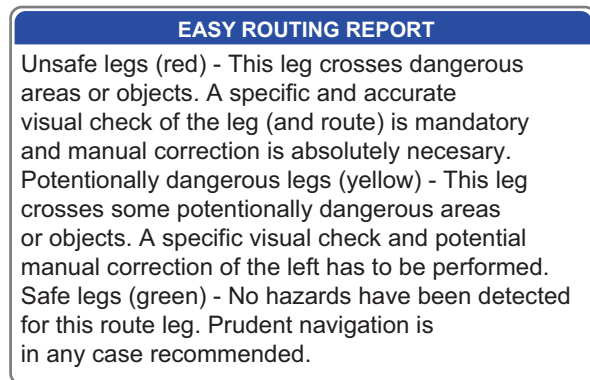

7. Click the [OK] button. (To get detailed information about the route, “click” the [DETAILS] button. Press the **ESC/MENU** key to close the detailed report.)
8. The Easy Routing created route appears.

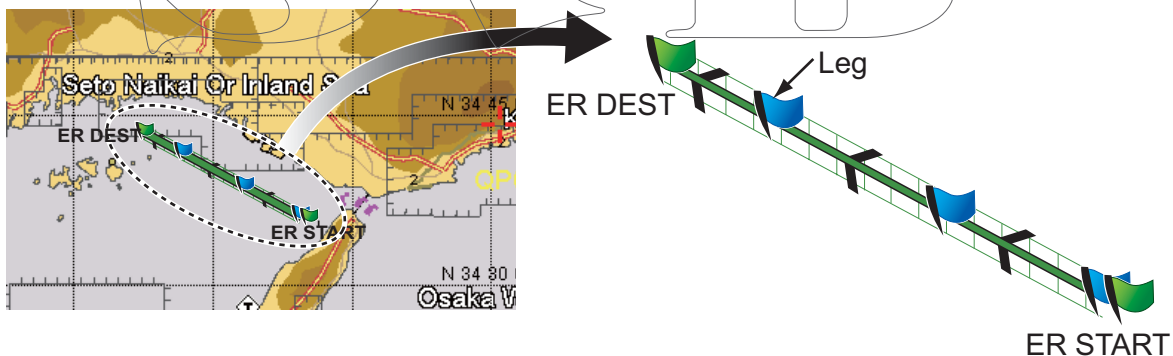

In the above example, five legs were created. Legs are color coded according to safety levels, red for unsafe, yellow for potentially dangerous, and green for safe. In the example, all legs were judged to be safe therefore the line between the start and destination is completely green. If the route has an unsafe or potentially dangerous leg, retry the calculation, with different locations.

9. Press the **ENT** key to save the route, or press the **ESC/MENU** key to escape without saving the route.

The Easy Routing created graphic is removed. If you saved the route, the Start and Destination flags and the route remain on the screen. If you exited without saving the route, only the Start and Destination flags remain on the screen. The flags can be removed by selecting [DELETE] at [START POINT] and [DESTINATION POINT] on the [EASY ROUTING] menu. The flags are also removed when the power is turned off.

Error messages in Easy Routing

Error message	Meaning	Remedy
Latitude of the defined points is greater than 80°. Route has not been calculated.	The latitude of the points is over 80°N/S.	Reselect the points.
No charts with Easy Routing data found. Calculation cannot be started.	You tried to use Easy Routing with no chart data.	Insert appropriate chart card.
Route calculation has been halted.	You canceled route calculation.	–
Route has not been calculated.	Route cannot be calculated in a situation other than those mentioned above.	Reselect points and try the calculation again.
Route is too complex, calculation could not complete.	The route is too complex to calculate.	Try to select a slightly different set of points.
Start and destination points are too far away. Calculation cannot be stored.	The start and destination points are more than 100 NM apart.	Reduce the distance between points to 100 NM or less.
Start and destination points placed in the same position. Route has not been calculated.	Start and destination positions are the same.	Select different positions.
Start or destination point of route cannot be moved to a navigable position on water. Route has not been calculated.	One or both points of the route are on land or on a forbidden area.	Reselect the points.
Timeout has been exceeded. Route has not been calculated.	The route could not be generated within the time specified with [TIMEOUT] in the [EASY ROUTING] menu.	Retry the calculation.

4.3 How to Extend a Route on the Screen

You can extend a route from the last point on the route. This is useful when you want to travel beyond the last point in a route.

1. Put the cursor on any leg of the route then press the **ENT** key.
2. Select [EXTEND] from the context-sensitive menu then press the **ENT** key.
3. Drag the cursor to where you want to extend the route. A dashed line runs between the last point and the cursor.
4. Press the **ENT** key. The dashed line is replaced with a solid line and the point is numbered with the next sequential point number of the route.

4.4 How to Insert a Point on a Route on the Screen

You can put a point between route legs when you need an additional point along a route.

1. Put the cursor on a leg of the route.
2. Press the **ENT** key, select [INSERT] then press the **ENT** key. A dashed line is overlaid on the selected leg.
3. Drag the cursor to the location where to put the point then press the **ENT** key. The dashed line disappears and the leg is redrawn with a solid line.

4.5 How to Move a Point in a Route on the Screen

You can move a point in a route as follows:

1. Put the cursor on the point to move then press the **ENT** key.
2. Select [MOVE] then press the **ENT** key.
3. Drag the cursor to the new location for the point. The color of the point icon and the point name turn gray.
4. Press the **ENT** key to anchor the point. The color of the point and point name returns to yellow.

4.6 How to Delete a Point From a Route on the Screen

Unnecessary points in a route can be deleted as shown below. You can also delete a route point from the [Routes List]. See section 4.7.2.

1. Put the cursor on the point to delete then press the **ENT** key.
2. Select [DELETE] then press the **ENT** key. You are asked if you are sure to delete the point.
3. [YES] is selected; press the **ENT** key to delete the point.

The route is redrawn omitting the deleted point.

4.7 Routes List

4.7.1 How to display the Routes List

The [Routes List] shows all the routes saved to the internal memory. To show the [Routes List], open the [PLOTTER] menu and select [ROUTES].

Use the up and down arrows on the **CursorPad** to scroll the list. For multiple pages, switch between pages with the right and left arrows on the **CursorPad**.

Routes List				
No	Name	Comment	Length	RTE Points
1	RT0001	12:03PM 03-23-12	16.26 NM	6

↑ Up, ↓ Down, ⇨ Forward, ⇩ Backward

New **Delete all** **Search**

Rotate ROTOkey to select function, press ROTOkey to execute

Function buttons

The three function buttons at the bottom of the [Routes List] do the functions shown below. Use the **RotoKey™** to access the buttons.

[New]: Create a route. See section 4.2 for the procedure.

[Delete all]: Delete all routes. See section 4.13.

[Search]: Search your routes. A text input box appears. Enter the search string then press the **ENT** key. The cursor selects the route whose name matches the search string.

4.7.2 Functions available in the Routes List

Context-sensitive menu

Select a route from the list then press the **ENT** key menu to show the context-sensitive menu.

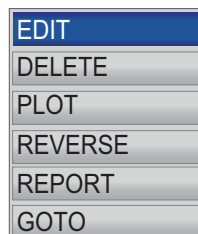

[DELETE]: Delete the selected route.

[PLOT]: Display the selected route on the plotter display.

[REVERSE]: Follow the selected route in reverse order. See the next chapter.

[REPORT]: Show the route report for the selected route.

[GOTO]: Navigate the route selected. See the next chapter.

Route editing function buttons

The route editing function buttons appear at the bottom of the screen when a route is selected for editing. Select the route from the [Routes List] then press the **ENT** key to show the context-sensitive menu. Select [EDIT] from the context-sensitive menu then press the **ENT** key.

Route Name: RT0001					
Comment: 12:03PM 03-23-12					
1	PT00001			PT00001	34°40.403N
	12:00PM 03-23			12:00PM 03-23	135°18.396E
2	PT00002	5.006		PT00002	34°35.396N
	12:00PM 03-23	180		12:00PM 03-23	135°18.396E
3	PT00003	4.119		PT00003	34°35.396N
	12:00PM 03-23	90		12:00PM 03-23	135°23.399E
4	PT00004	2.757		PT00004	34°38.153N
	12:00PM 03-23	0		12:00PM 03-23	135°23.399E
5	PT00005	2.474		PT00005	34°40.627N
	12:01PM 03-23	0		12:01PM 03-23	135°23.399E
6	PT00006	1.901		PT00006	34°41.021N
	12:01PM 03-23	282		12:01PM 03-23	135°21.137E

↑ Up, ↓ Down, ⇐ Previous Page, ⇒ Next Page, [ENT] for options

Rename	Comment	Sort	Search	Connect	Coord Type
--------	---------	------	--------	---------	------------

Rotate ROTOkey to select function, press ROTOkey to execute

[Rename]: Rename the route. A text input box appears with the current route name in the box. Edit the name as appropriate.

[Comment]: Enter a comment for the route, using the **CursorPad**. A maximum of 64 alphanumeric characters may be used. The comment is the time and date the route was created.

[Sort]: Sort the list according to the sort options:

[A-Z ASCENDING]: Alphabetical order

[Z-A DESCENDING]: Reverse alphabetical order

[DISTANCE ASCENDING]: Distance in ascending order

[DISTANCE DESCENDING]: Distance in descending order

[Search]: Enter a search waypoint name then press the **ENT** key. The cursor selects the waypoint that matches the name entered.

[Connect]: Connect the selected route to the last point of the route edited. See section 4.10.

[Coord Type]: Select the position display format for points globally, among ddd°mm'ss, ddd°mm.mmm, ddd°mm.mmmm, ddd.dddddd.

4.8 Route Report, Route Calculator

A route report provides detailed information about a route plus a route navigation calculator. The route navigation calculator lets you see the time necessary to travel to each leg and the amount of fuel required for each leg with various speeds and fuel consumption figures.

Route report

To show the route report, select a route on the [Routes List] then press the **ENT** key. Select [REPORT] from the context-sensitive menu then press the **ENT** key. The report provides the following information:

- The name of each point
- The position of each point
- The bearing to each point
- The distance to each point
- The total distance between points and total distance of the route
- The time required to get to a point using the speed selected
- The amount of fuel required to get to a point and the total amount of fuel required to run the route.

Route Report						
ROUTE:	0	NAME:	RT0001			
SPEED:	10.0 kn	FUEL:	2.64 gal/h			
RTE POINT	LATITUDE LONGITUDE	BRG [T]	DST [NM]	TDST [NM]	TIME	FUEL
PT00001	34°40.403N 135°18.396E					
PT00002	34°35.396N 135°18.396E	180	5.006	5.006	0:30	1.32
PT00003	34°35.396N 135°23.399E	90	4.119	9.125	0:54	2.41
PT00004	34°38.153N 135°23.399E	0	2.757	11.88	1:11	3.14
PT00005	34°40.627N 135°23.399E	0	2.474	14.36	1:26	3.79
PT00006	34°41.021N 135°21.137E	282	1.901	16.26	1:37	4.30

Speed Fuel

Note: A route report can also be shown by selecting the route on the screen. Select the route then press the **ENT** key. Select [INFO] from the context-sensitive menu.

Route calculator

Use the [Speed] and [Fuel] buttons at the bottom of the [Route Report] to enter speed and fuel consumption/hour. See how those values affect the [Time] and [Fuel] indications.

4.9 How to Display a Route on the Screen

Open the [PLOTTER] menu and select [ROUTES] to show the [Routes List]. Select a route then press the **ENT** key. Select [PLOT] from the context-sensitive menu then press the **ENT** key.

4.10 How to Connect Two Routes

You can connect two routes from the [Routes List]. In the example below route 1 is connected to route 2.

1. Open the [PLOTTER] menu and select [ROUTES] to show the [Routes List].
2. Select the starting route then press the **ENT** key.
3. Select [EDIT] from the context-sensitive menu then press the **ENT** key.
4. Use the **RotoKey**TM to select the [Connect] button (at the bottom of the screen) then press the **RotoKey**TM to display the routes list (at right half of the screen).

Route Name: RT0001 Comment: 12:03PM 03-23-12					
1	PT00001 12:00PM 03-23		RT0001	6	
2	PT00002 12:00PM 03-23	5.006 180	RT0002	7	
3	PT00003 12:00PM 03-23	4.119 90			
4	PT00004 12:00PM 03-23	2.757 0			
5	PT00005 12:01PM 03-23	2.474 0			
6	PT00006 12:01PM 03-23	1.901 282			

↑ Up, ↓ Down, ⇐ Previous Page, ⇒ Next Page, [ENT] for options

Rename	Comment	Sort	Search	Connect	Coord Type
--------	---------	------	--------	----------------	------------

Rotate ROTOkey to select function, press ROTOkey to execute

5. Select route 2 then press the **ENT** key.

The joined route is saved under the name of route 1. If the total number of points exceeds 50, the excess is removed from the end of the route.

4.11 Simple Route Information

You can find simple route information for a route by putting the cursor on a leg of the route. The name of the route and the date of its creation are shown.

Route Information	
Name	RT0001
Comment	12:20PM 03-16-12

4.12 How to Rename a Route on the Screen

The default name for a route is RTXXXX (XXXX=route number). If desired, you can rename the route with one more descriptive.

1. Put the cursor on the route to rename then press the **ENT** key.
2. Select [Rename] then press the **ENT** key. An input box showing current route name appears.
3. Edit the name as appropriate then press the **ENT** key.

4.13 How to Delete Routes

Routes can be deleted individually or collectively. A route currently used for navigation cannot be deleted.

4.13.1 How to delete a route on the screen

1. Put the cursor on a leg of the route to delete then press the **ENT** key.
2. Select [DELETE] then press the **ENT** key. You are asked if you are sure to delete the route.
3. [YES] is selected; press the **ENT** key to delete the route.

The route is deleted from the screen and the [Routes List].

4.13.2 How to delete routes from the Routes List

Individual route

1. Open the [PLOTTER] menu and select [ROUTES].
2. Select a route then press the **ENT** key.
3. Select [DELETE] from the menu then press the **ENT** key.

All routes

You can delete all routes from the list as follows:

1. Open the [PLOTTER] menu and select [ROUTES].
2. Use the **RotoKey**TM to select [Delete all] (at the bottom of the screen) then push the key. You are asked if you are sure to delete all routes.
3. [YES] is selected; press the **ENT** key to delete all routes.

5. NAVIGATION

This chapter shows you how to get to a desired destination by using “quick points,” saved points, and routes.

Before you go to a point or follow a route, make sure the path to the points is clear. Zoom your chart to check for hazards which appear on a smaller scale.

5.1 How to Navigate to a Quick Point

The advantage of navigating to a quick point, the cursor position, is that you do not need to save the point to the memory. However, the point is erased when a new quick point is entered.

Put the cursor on the position to mark as a quick point then long-push the **POINTS/GO TO** key. Then,

- A yellow circle appears at the location, with the youngest empty quick point number below it. The navigation line (red) connects between own ship and the quick point, your destination. The line shows the shortest path to the destination and the direction to go.

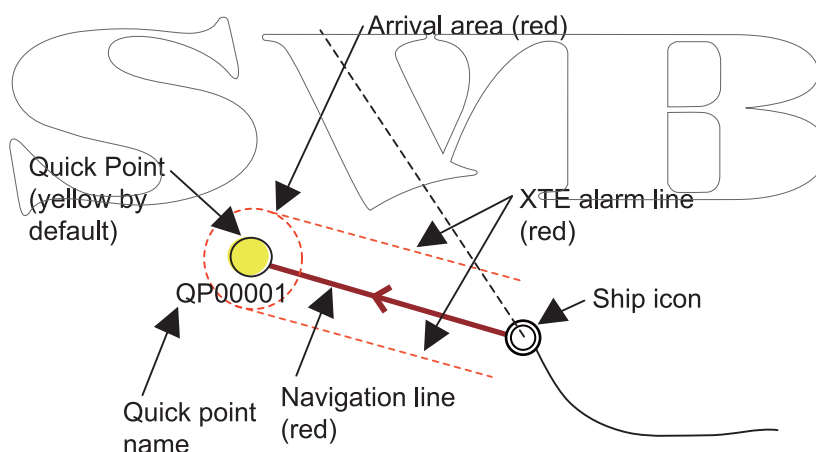

- The arrival area, the radius of which is set with the arrival alarm, is shown with a red dashed circle. When your boat comes within the circle or your boat moves through an imaginary perpendicular line that crosses through the center of the destination point, the audio alarm sounds and the arrival alarm icon appears at the top of the screen to alert you. The arrival area and XTE alarm lines are shown when the related alarms are active.
- The XTE alarm lines (red dashed lines), show the XTE alarm range, set with the XTE alarm. When your boat crosses an XTE line, audible and visual alarms are re-leased to alert you.

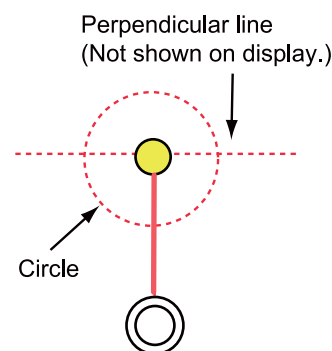

5.2 How to Navigate to a Saved Point

There are two methods by which to navigate to a saved point: select the point on the screen and select the point from the [Points List].

5.2.1 How to navigate to a saved point selected on the screen

Put the cursor on the saved point then press the **ENT** key. Select [GOTO] then press the **ENT** key. See the description on page 5-1 for the meaning of the symbols and lines and the sequence of events in navigation to a point.

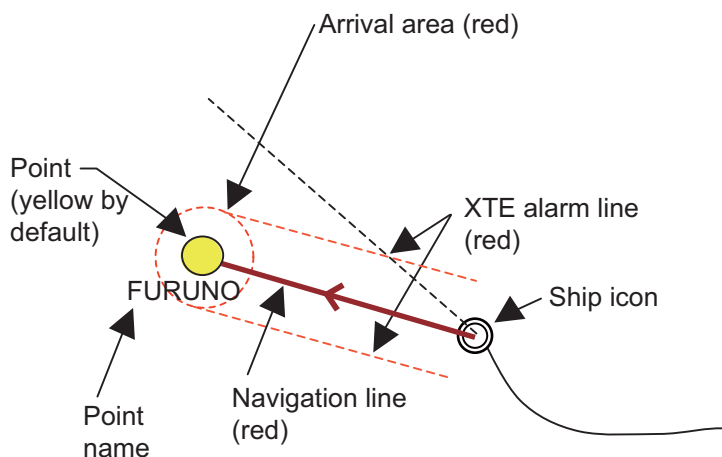

5.2.2 How to navigate to a point selected from the Points List

1. Open the [PLOTTER] menu and select [POINTS] to show the [Points List].
2. Select a point then press the **ENT** key to show the context-sensitive menu.
3. Select [GOTO] then press the **ENT** key.

5.3 How to Select a Route for Navigation

There are two methods to select a route for navigation: select the route on the screen and select the route from the [Routes List].

5.3.1 On-screen route

Put the cursor on any route leg of the route then press the **ENT** key to show the context-sensitive menu. Select [GOTO] then press the **ENT** key.

Note: If you are currently navigating a route, the message "Destination is already present. Stop the navigation." appears. Select [YES] to stop navigation on the current route and switch to the newly selected route, or select [NO] to continue navigation with the current route.

After you select a route the following occurs:

- A red line runs between the points on the route. The line shows the shortest path to the destination and the direction to go.

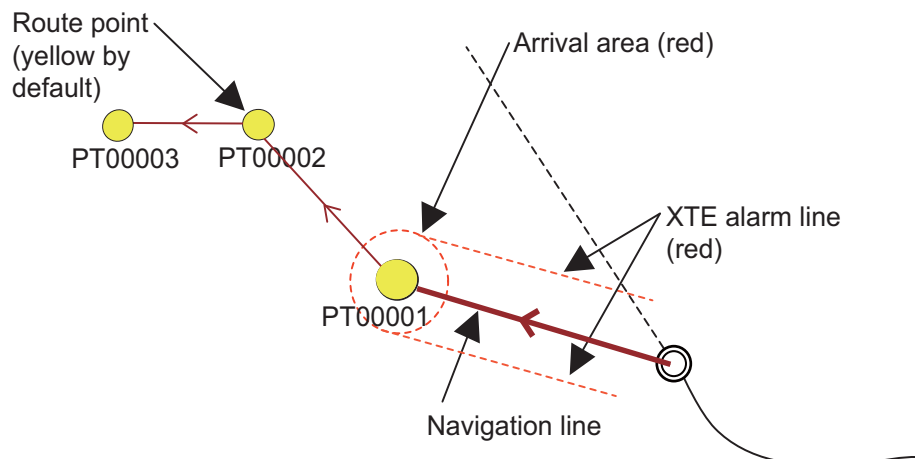

- The arrival area, the radius of which is set with the arrival alarm, is shown with a red dashed circle. When your boat comes within the circle or your boat moves through an imaginary perpendicular line that crosses through the center of the destination point, the audio alarm sounds and the arrival alarm icon appears at the top of the screen to alert you. See the description on page 5-1.
- After you arrive to a point, the arrival area marker and the dashed line are switched to the next waypoint.

5.3.2 Route selected from the Routes List

Open the [PLOTTER] menu and select [ROUTES] to show the [Routes List]. Select a route and then press the **ENT** key to show the context-sensitive menu. Select [NAVIGATE] from the menu. See the description and figure in section 5.3.1 for the sequence of events in route navigation. Note that the route points of a route created from the [Routes List] are marked as "PTxxxxx".

5.3.3 How to start navigation from a point on a route

Depending on your position, objective, etc., you may want to skip some route points on a route and start navigating directly to a specific point. Put the cursor on a route point then press the **ENT** key to show the context-sensitive menu. Select [ACTIVATE FROM] then press the **ENT** key.

5.4 Functions Available When You Follow a Route

5.4.1 Restart navigation

When you follow a route, you can restart the navigation to the next point on the route from current location.

When you steer to keep away from an obstruction or your boat drifts, you go off course, like shown with Line 1 in the figure. If you do not need to return to the original course, you can go to the desired point from the current position as shown in Line 2 in the figure.

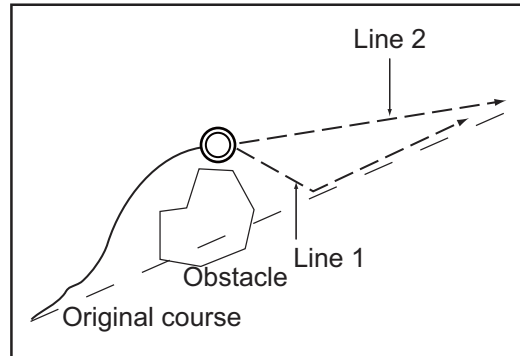

Put the cursor on a leg in the route then press the **ENT** key to show the context-sensitive menu. Select [RESTART] then press the **ENT** key. The route start position moves to the current position and the XTE is reset to zero.

5.4.2 Follow a route in reverse order

You can follow the route points of a route in reverse order. This feature is useful when you want to retrace a route from the end to the beginning.

Put the cursor on a leg in the route then press the **ENT** key to show the context-sensitive menu. Select [REVERSE] then press the **ENT** key. The arrows on the route now point in the opposite direction.

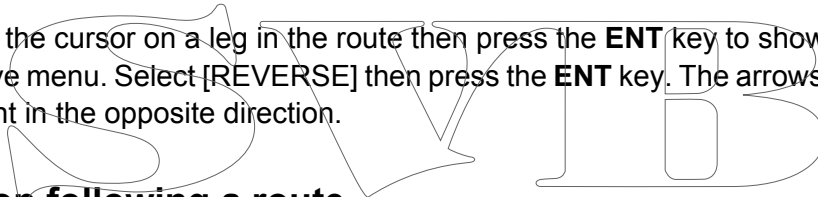

5.4.3 Stop following a route

Put the cursor on a leg in a route then press the **ENT** key to show the context-sensitive menu. Select [STOP] then press the **ENT** key. The arrival area, XTE alarm lines are erased and the color of the legs connecting the route points of the route changes to blue.

5.4.4 Skip a leg in a route

When you don't need to follow all route legs in a route you can skip an unnecessary leg. (Multiple legs can be skipped) After you select the leg to skip, the route is re-drawn, with the skipped leg removed. Put the cursor on the route point to skip then press the **ENT** key to show the context-sensitive menu. Select [SKIP] then press the **ENT** key.

6. MAP SETTINGS, 2D PERSPECTIVE/3D DISPLAYS AND SATELLITE OVERLAY

This chapter shows you how to set up the map display and how to select the 2D perspective and 3D displays.

6.1 Map Setup

All map settings are in the [MAP] menu. On this menu you can

- Change icon size
- Change the size of the place names
- Select nav aids presentation format
- Select chart language
- Predict tide movement
- Configure the information to show

Open the [MAP] menu and set items according to your operating needs.

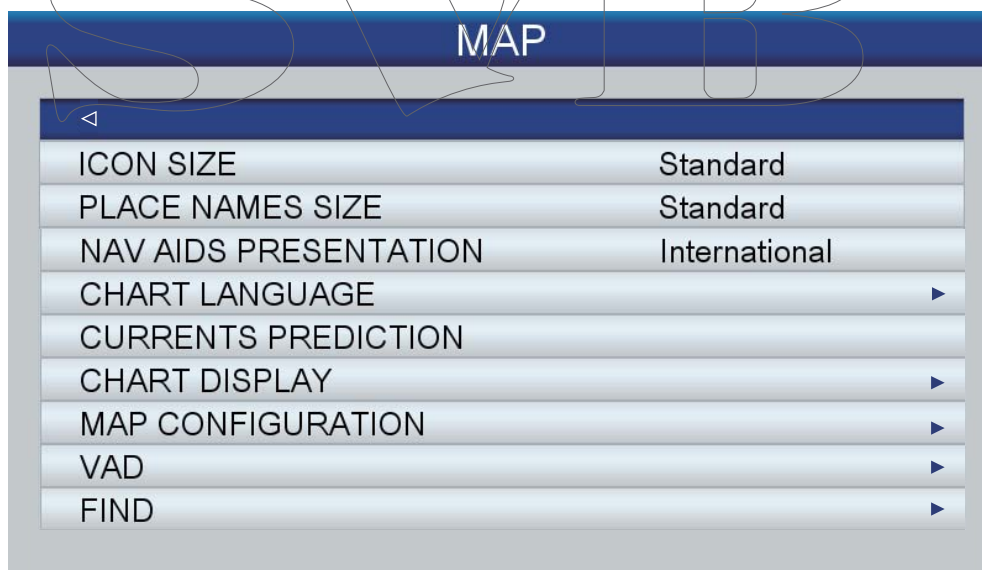

[ICON SIZE]: Select the size for the icons (buoy, lighthouse, etc.). The choices are [Standard] or [Large].

[PLACE NAMES SIZE]: Select the size for the place name indications, among [Standard], [Medium] or [Large].

[NAV AIDS PRESENTATION]: Select nav aids presentation format, [US] or [International].

[CHART LANGUAGE]: Use **[Language]** to select the chart language to use to show chart information (place names, etc.), among English and major European and Asian languages. Use **[Mode]** to select what language to display chart information in.

[Off]: Chart information is shown in English when it is not available in the chart language selected.

[English]: Chart information is shown in the chart language selected when English is not available.

[Local]: Chart information is shown in the local language when it is not available in the chart language selected.

[CURRENTS PREDICTION]: Predict current (tide) movement in the specified time interval.

Currents Prediction	
03-16-12	01:25:32:PM
SPD 1.9 kn	DIR 302° T

Rotate the **RotoKey™** to set the time for which to show predicted current movement. Push the **RotoKey™** for three seconds to enable entry of date. Use the **CursorPad** to enter the date for which to show predicted current movement.

[CHART DISPLAY]: Setup the overlay displays.

[PLOTTER WINDOW]: Select which display to apply the settings of **[CHART DISPLAY]** in the 2-way split screen for the plotter display. The default setting puts the display on the left half.

[DISPLAY MODE]: Select the chart display mode, among **[2D]**, **[2D Perspective]** and **[3D]**.

[OVERLAY]: Select the type of overlay to use, among **[Vector]**, **[Satellite]**, **[Raster]** and **[Chart Shading]** (not available in the 3D display).

[OVERLAY MODE]: Select where to display the overlay, **[On Land]**, **[On Sea]** or **[On All]**. (Available in 2D and 2D perspective modes when **[Satellite]** or **[Chart Shading]** is selected at **[Overlay]**.)

[TRANSPARENCY]: You can set the level of transparency for the satellite photo on the water. The higher the figure the greater the level of transparency.

[3D EXAGGERATION FACTOR]: Set the level of the 3D exaggeration factor, Level 1 to Level 5, to view topographical features more easily. The higher the number the greater the exaggeration.

[MAP CONFIGURATION]: Show or hide various objects to set the level of detail for your maps. **[Display Mode]** offers four preset levels (full, medium, low and tides) plus a custom level which you can set according to your needs. The table on the next page shows the settings for each of the four preset levels. You can zoom in the chart range over the range which is limited by the chart when setting **[Off]** in **[CHART LOCK]**. However, if done the chart can not be displayed correctly.

6. MAP SETTINGS, 2D PERSPECTIVE/3D DISPLAYS AND SATELLITE OVERLAY

Item	Display Level				Available Settings
	Full	Medium	Low	Tides	
MARINE SETTINGS					
NAMES	On	On	Off	On	On, Off
HAZARD AREAS LABELS	On	Off	Off	Off	On, Off
NAV-AID NAMES	On	Off	Off	Off	On, Off
PORT NAMES	On	Off	Off	Off	On, Off
NAV AIDS & LIGHT SECTORS	On	No sector	No sector	Off	On, Off, No sector
ATTENTION AREAS	On	On	Off	Off	On, Off
TIDES & CURRENTS	On	Off	Off	On	On, Off
SEABED TYPE	On	Off	Off	Off	On, Off
PORTS & SERVICES	On	On	Off	Off	On, Off
TRACKS & ROUTES	On	Off	Off	Off	On, Off
UNDERWATER OBJECTS SETTINGS					
UNDERWATER OBJECTS LIMIT	32.8	32.8	32.8	32.8	0.0 to 1000.0 ft
ROCKS	Icon+Depth	Icon	Icon	Icon	Icon, Icon+Depth
OBSTRUCTIONS	Icon+Depth	Icon	Icon	Icon	Icon, Icon+Depth
DIFFUSERS	Icon+Depth	Icon	Icon	Icon	Icon, Icon+Depth
WRECKS	Icon+Depth	Icon	Icon	Icon	Icon, Icon+Depth
DEPTH SETTINGS					
DEPTH SHADING MODE	Dynamic	Dynamic	Dynamic	Dynamic	Safe, Dynamic, Dynamic Inverted
SAFE DEPTH	15.0	15.0	15.0	15.0	0.0 to 1000.0 ft
DEPTH RANGE MIN	0.0	0.0	0.0	0.0	0.0 to 32804.0 ft
DEPTH RANGE MAX	32804.0	32804.0	32804.0	32804.0	0.0 to 32804.0 ft
CHART SETTINGS					
LAT/LON GRID	On	Off	Off	Off	On, Off
BOUNDARIES MODE	AUTO	AUTO	AUTO	AUTO	AUTO, Manual
CHART BOUNDARIES	On	Off	Off	Off	On, Off
VAD BOUNDARIES	On	Off	Off	Off	On, Off
CHART LOCK	On	On	On	On	On, Off

[VAD]: Value Added Data. Show or hide land VAD.

[Standard land VAD]: Select [On], [Off] or [Custom] at [DISPLAY] to show or hide standard land VAD. For [Custom], select which items to show or hide at [CUSTOMIZE].

The choices are [Road] and [Land Elevation].

[Standard marine VAD]: Select [On], [Off] or [Custom] at [DISPLAY] to show or hide standard marine VAD. For [Custom], select which items to show or hide at [CUSTOMIZE]. The choices are [Tide height station], [Port/Marina] and [Tide stream station].

Note: You can display [VAD] with the **RotoKey™**. Long-press the **RotoKey™** to open the full RotoKey menu then select [VAD].

6. MAP SETTINGS, 2D PERSPECTIVE/3D DISPLAYS AND SATELLITE OVERLAY

[FIND]: The find feature helps you locate ports, tide stations, wrecks, obstructions, and points of interests (attractions, medical service, entertainment, shopping, etc.). **[COORDINATES]** puts the cursor on the position you enter.



For example, select **[PORT BY DISTANCE]** to find the ports closest to your current position.

PORT BY DISTANCE		
Name	BRG [T]	DST [NM]
TADOTSU - TADOTSU	242	0.096
MARUGAME - MARUGAME	47	2.075
SAKAIDO KO - SAKAIDE	58	6.275
MIZUSHIMA - MIZUSHIMA	1	12.19
HIBI - HIBI	41	14.00
UNO KO - UNO KO	39	16.46
TAKAMATSU - TAKAMATSU	72	16.48
OKAYAMA - OKAYAMA	31	22.71
KOMATSUSHIMA - KOMATSUSHIMA	110	45.25
AIOI - AIOI	50	46.59

The list shows the name, bearing and distance to each port, in ascending distance. To find the location of a port on the chart, select the port then press the **ENT** key. The screen closes and the chart appears, with the port put at the center of the screen.

How to hide the place names

Do the following to hide the place names on the chart.

1. Select **[MAP CONFIGURATION]** from the **[MAP]** menu.
2. Open **[DISPLAY MODE]** then select **[Custom]**.
3. Open **[NAMES]** then select **[Off]**.
4. Press the **ESC/MENU** key to close the menu. To display the place names, select **[On]**.

6.2 2D Perspective Display

The 2D perspective display provides an aerial perspective display. Select [2D/3D] Mode and [2D Perspective] from the RotoKey menu to show this display.

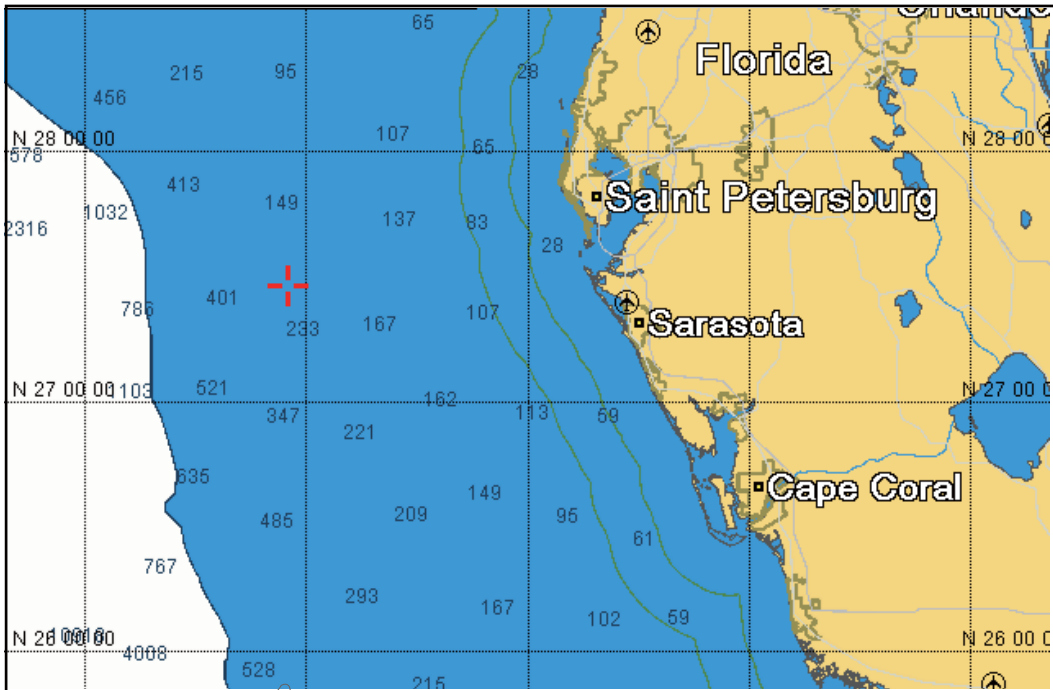

2D display

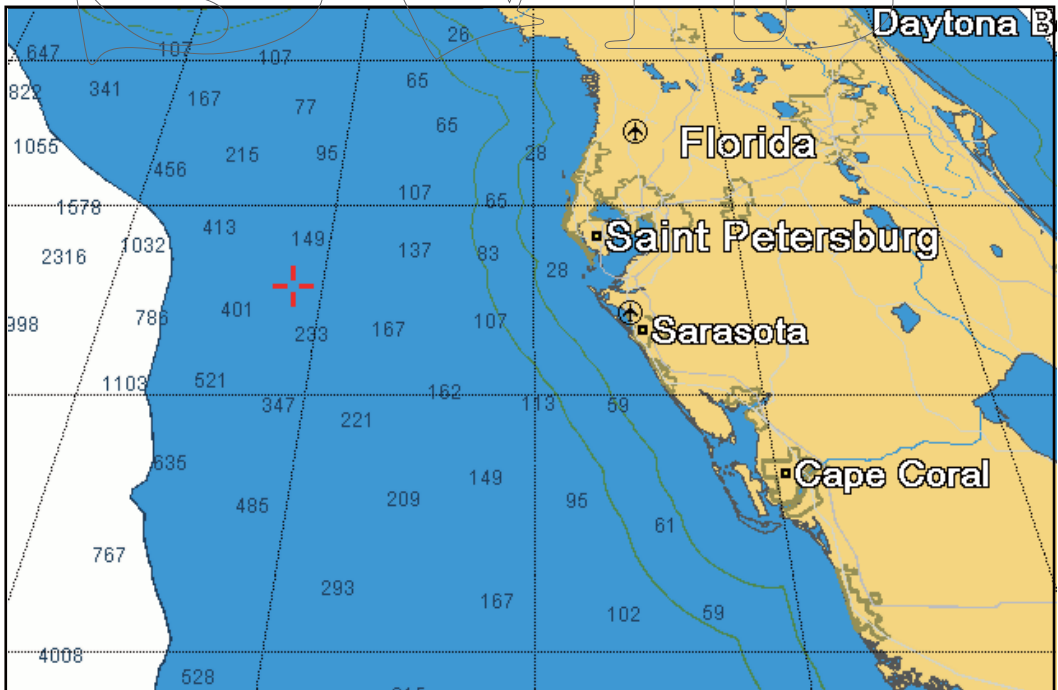

2D perspective display

6.3 3D Display

6.3.1 3D display description

The 3D display has native 3D chart design that allows full time 3D presentation. This true 3D environment gives you all of the information you require with no restrictions on the information you can see. You can plan your routes, enter points, etc. like on the 2D chart. To show the 3D display, select [2D/3D Mode] and [3D] from the RotoKey menu. The 3D icon, whose appearance changes according to display adjustment state, appears to the right of the orientation mode box.

The 3D display provides a 3D view of land and sea around your boat. Land is shown in different shades of green according to height above the sea level. Water is shown in different shades of blue according to depth. The 3D display has most of the same information as the 2D display. With both presentations available you can see the conditions around your boat from different angles. The 3D display helps you navigate when you are in waters that you do not know. Also, most functions of the 2D display, for example, destination setting, are available in the 3D display.

For best results make sure you have accurate position and heading data.

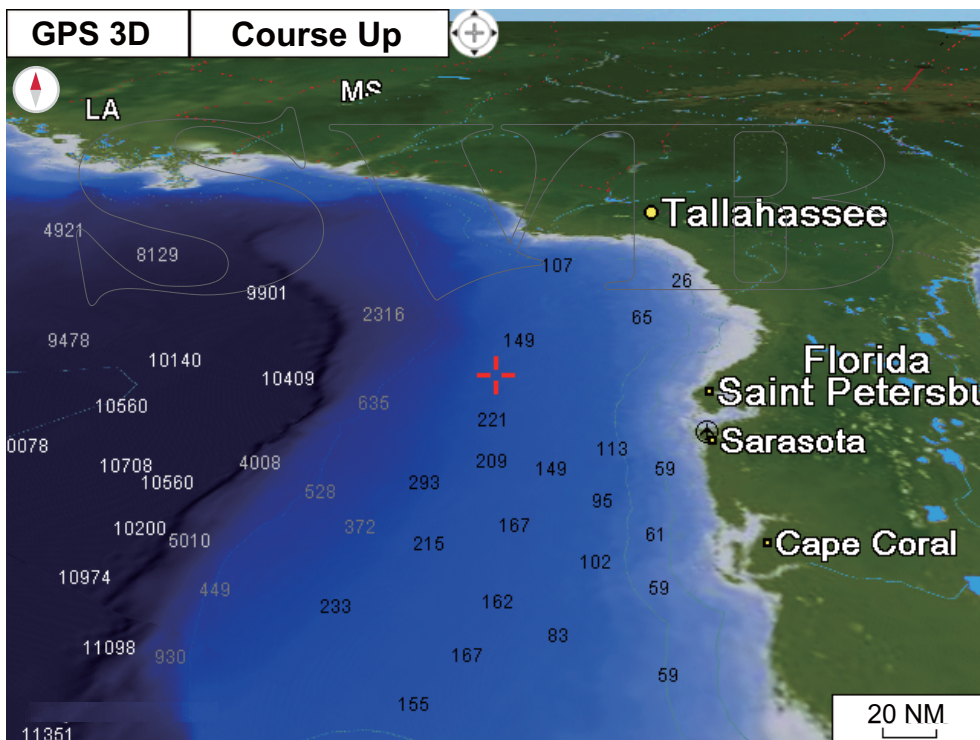

6.3.2 How to tilt and rotate the 3D display

To tilt and rotate the 3D display, first select [Mode] and [Manual] from the RotoKey menu. [Manual] appears in the orientation mode box. Long-push the **ENT** key to enable adjustment. The appearance of the 3D icon changes as shown in the illustration below.

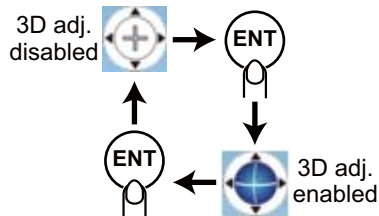

Tilt the chart: Operate the up and down arrow pads on the **CursorPad**.

Rotate the chart: Operate the right and left arrow pads on the **CursorPad**.

After you complete the adjustment, long-push the **ENT** key to confirm settings. To escape from the manual adjustment mode, select an orientation mode from the RotoKey menu.

6.3.3 How to make the 3D view clearer

In the 3D display, some topographical features are easier to see if you use the [3D Exaggeration Factor]. This feature expands both objects on the chart and the underwater vertically so that you can easily see the shape of the objects and position. To adjust the exaggeration feature, open the [MAP] menu, select the [CHART DISPLAY] menu and set the level with [3D EXAGGERATION FACTOR]. Five levels are available. The higher the level the greater the degree of exaggeration. The example below compares the same picture in Level 1 and Level 5 exaggerations.

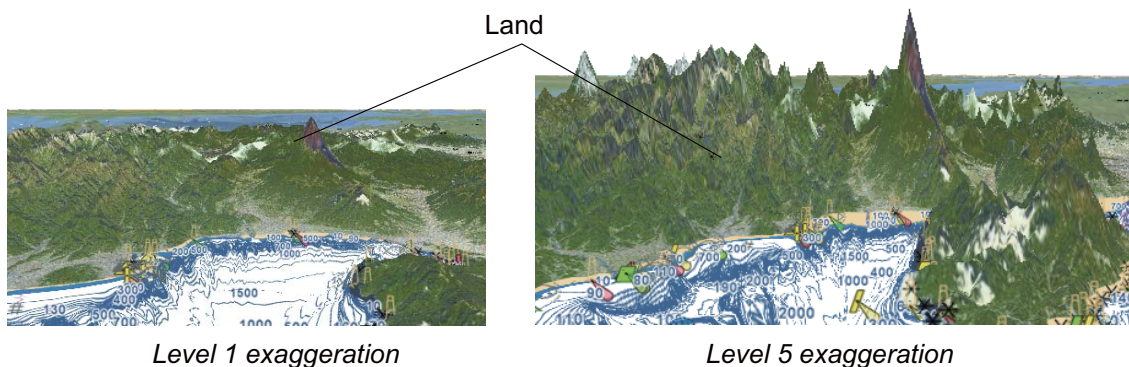

6.4 Satellite Photo Overlay

You can overlay the satellite photo for your area on the 2D and 3D displays. Open the RotoKey menu then select [2D/3D Mode], [2D] or [3D] and [Vector/Satellite] to show the satellite photo.

The illustration below shows the vector chart with the satellite photo overlay.



How to set the level of transparency

You can select the level of transparency for the parts of the satellite photo that are on water. Open the [MAP] menu and select [CHART DISPLAY] and [TRANSPARENCY]. Set the level in three digits, from 0 to 100. The higher the number the greater the degree of transparency.

7. FISH FINDER OPERATIONS

7.1 How the Fish Finder Works

The fish finder calculates the distance between its transducer and underwater objects like fish, lake bottom or seabed. The results are shown in different colors or shades of gray according to echo strength.

The ultrasonic waves transmitted through water move at a constant speed of approximately 4800 feet (1500 meters) per second. When a sound wave "hits" an underwater object like fish or sea bottom, part of the sound wave is reflected toward the source. To find the depth to an object, the fish finder calculates the time difference between the transmission of a sound wave and the time the reflected sound wave is received.

The picture displayed by the fish finder contains a series of vertical scan lines. Each line is a "picture" of the objects under your boat. The series of pictures are put side-by-side across the screen to show the contours of the bottom and echoes from fish. The amount of history of objects that have moved under your boat can be less than a minute to more than one minute depending on the picture advance speed.

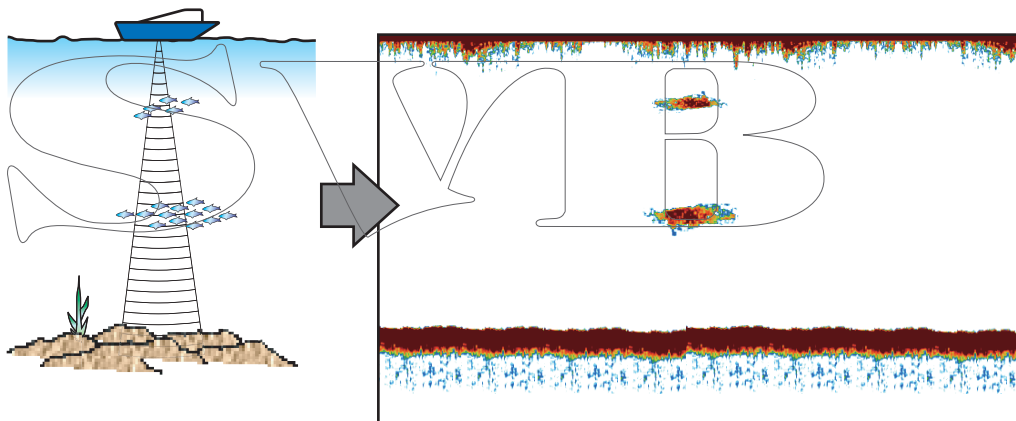

7.2 Fish Finder Display

The fish finder screen provides a “picture” of the echoes found by the fish finder. Echoes are scrolled across the screen from the right position to the left position. The number of minutes an echo is displayed on the screen is controlled by the picture advance speed.

The echoes at the right position are the current echoes. These echoes can be from individual fish, a school of fish, or the bottom. Depth to the bottom is indicated always, provided the gain is set correctly.

Both low and high TX frequencies are provided. (Frequencies depend on the transducer connected.) The low frequency has a wide detection area, which is useful for general detection and understanding bottom conditions. The high frequency has a narrow beam width that helps you inspect fish.

The range, gain, clutter and TVG can be adjusted automatically according to your purpose (cruising or fishing) to let you do other tasks.

The color bar at the left edge of the display shows the range of colors used to display different echo strengths. Weaker echoes appear in colors near the bottom of the bar, and stronger echoes appear in colors near the top of the bar.

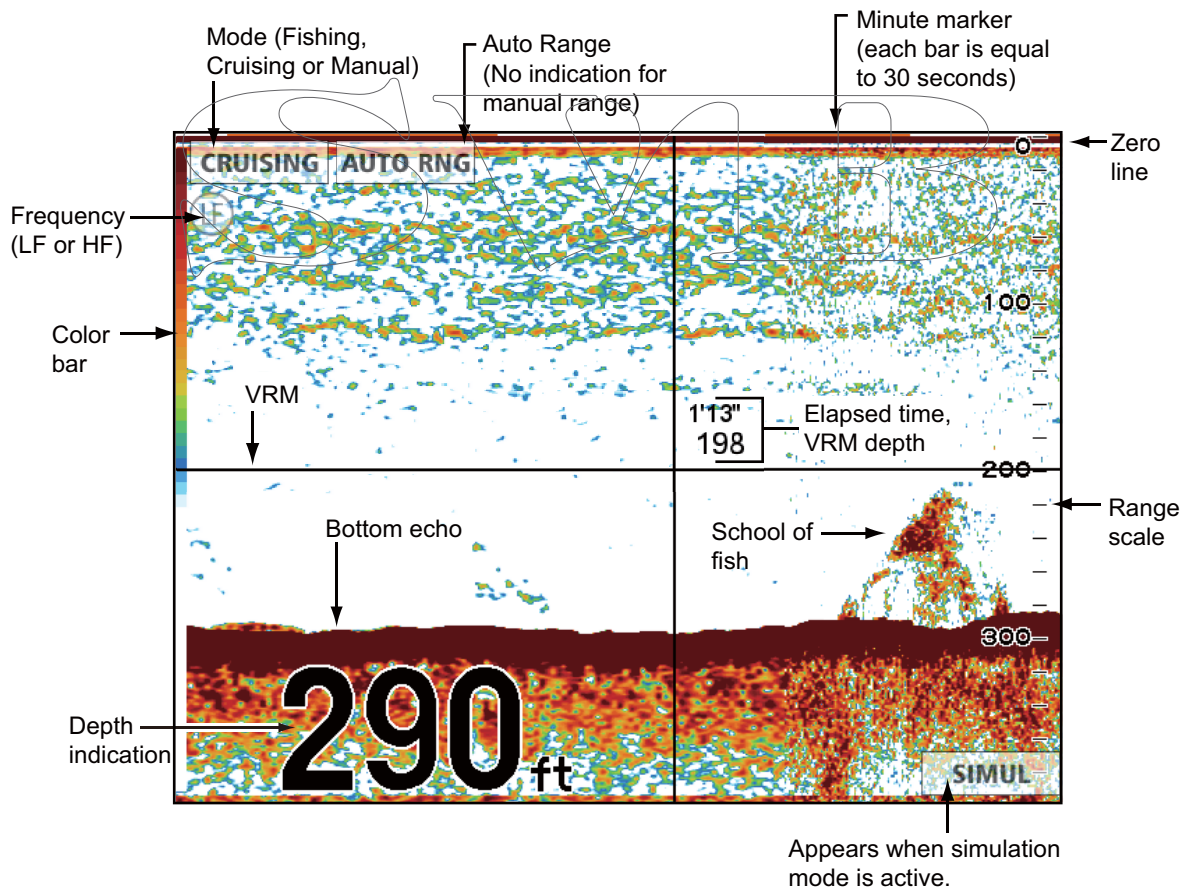

Note: The depth indication on the fish finder display is the sounding value from the internal fish finder. The DEPTH indication in the data box is the sounding value from the equipment selected in the [INTERFACE] - [SELECT INPUT DEVICE] menu. Then, the depth value in the data box can be different if the data is fed from an external device.

7.3 How to Activate the Fish Finder

Select a fish finder display at the home screen. See section 1.8.

7.4 How to Select a Display

Your fish finder has these display modes: single frequency (50 kHz or 200 kHz), dual frequency (50 kHz + 200 kHz), bottom lock, bottom zoom, marker zoom, A-scope, and bottom discrimination.

7.4.1 How to select a single frequency or dual frequency

Single frequency

The single frequency display shows either the low-frequency or high-frequency picture on the full screen. Select a frequency according to your purpose.

- A low frequency gives a wide detection area. Use the low frequency for general search and to find bottom conditions.
- A high frequency gives better resolution. Use the high frequency to inspect a school of fish.

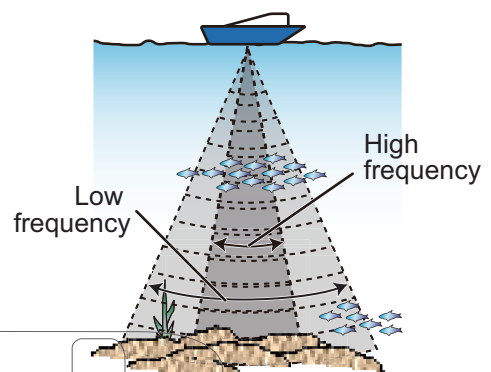

To select a single frequency display, open the RotoKey menu, select [Frequency] then [200 kHz] or [50 kHz].

Dual frequency

The dual frequency display provides both low- and high-frequency pictures. Use the dual frequency display to compare the same picture with two different sounding frequencies. The low-frequency picture is on the left, and the high-frequency is on the right.

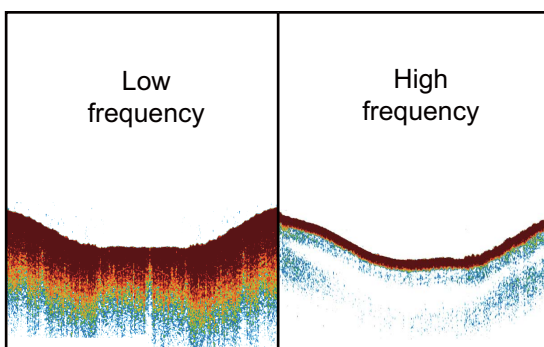

Freq. (kHz)	Beamwidth	Resolution	Detection range	Bottom tail
Low	Wide	Low	Deep	Long
High	Narrow	High	Shallow	Short

To select a dual frequency display, open the RotoKey menu then select [Frequency] and [Dual].

7.4.2 How to select a zoom display

The zoom displays appear on the left-half of the screen and the high or low frequency display on the right half. Three zoom displays are available: bottom lock, bottom zoom and marker zoom.

How to activate a zoom display

Open the full RotoKey menu, select [Zoom] then [Btm Lock], [Btm Zoom] or [Mkr Zoom]. To deactivate the zoom display, select [Off] after selecting [Zoom].

Bottom lock display

The bottom lock display provides a compressed normal picture on the right half and a 7 to 400 feet (3 to 120 meter) wide layer in contact with the bottom is expanded on the left half. This display helps you distinguish the fish near the bottom from the bottom echo. You can select the bottom lock range with [BOTTOM LOCK RANGE] in the [RANGES] menu in the [FISH FINDER] menu.

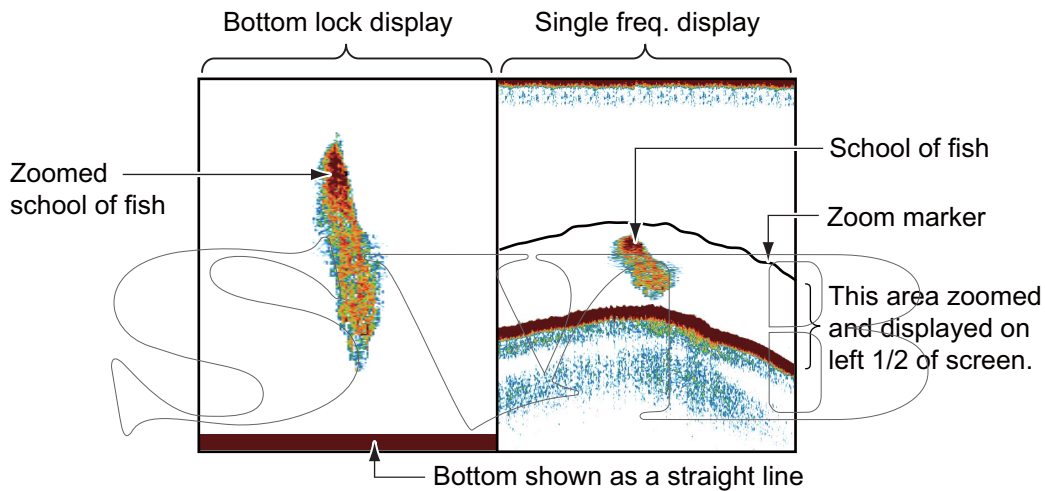

Bottom zoom display

The bottom zoom display expands the bottom and the fish near the bottom according to the zoom range selected with [ZOOM RANGE] in the [RANGES] menu in the [FISH FINDER] menu. This display helps you find the density of the bottom. A bottom displayed with a short echo tail normally indicates a soft bottom (sand bottom, etc.). A long echo tail indicates a hard bottom.

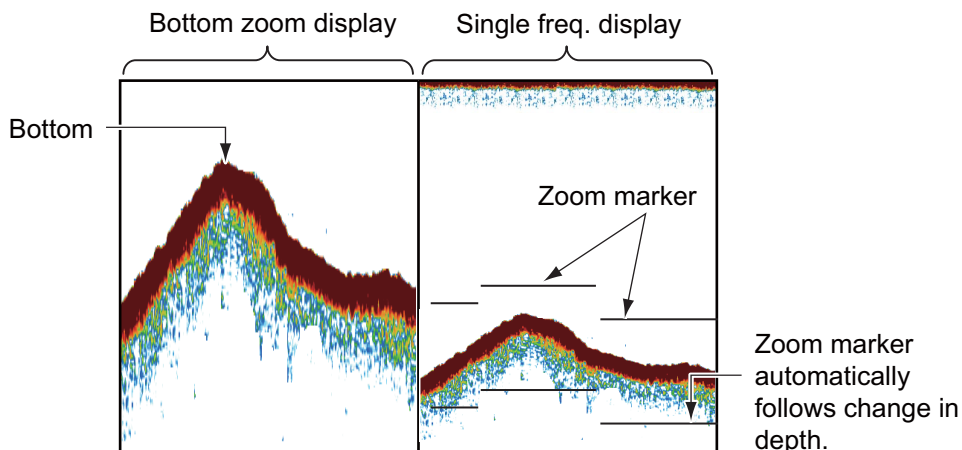

Marker zoom display

The marker zoom display expands a selected area of the normal fish finder picture to full vertical size of the screen on the left-half window. You can select the part to expand with the VRM (Variable Range Marker). Move the zoom marker with the **Cursor-Pad**. The area between the VRM and zoom marker is expanded. The marker can be shown or hidden with [ZOOM MARKER] in the [FISH FINDER] menu.

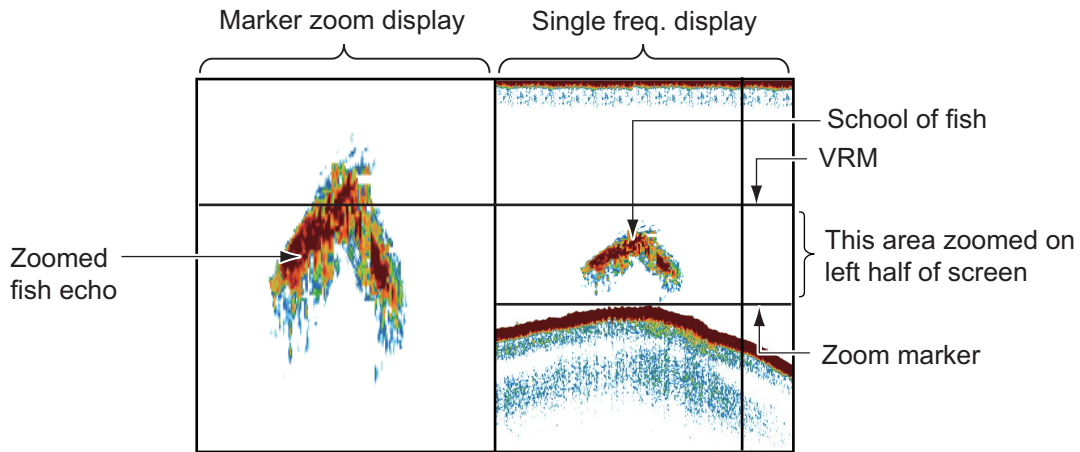

7.4.3 A-scope display

The A-scope display appears at the right 1/16 of the screen and is available in any fish finder mode. This display shows the echoes at each transmission with the amplitudes and tone in balance with their intensities. This display helps you identify possible fish species and bottom structure. To show or hide the A-scope display, open the full Ro-toKey menu then select [A-scope] to activate or deactivate the display.

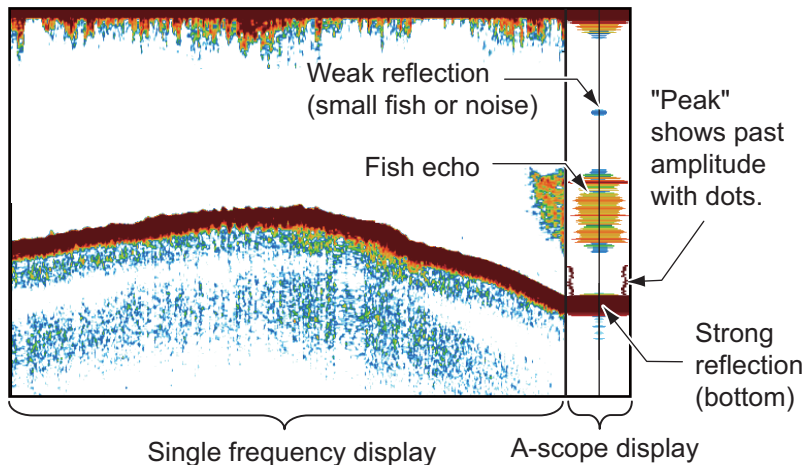

A-scope peak hold

You can show the "normal" A-scope display plus the peak-hold amplitude picture for the last five seconds in dots. To show the peak hold display, turn on [A-SCOPE PEAK HOLD] in the [FISH FINDER] menu.

7.4.4 Bottom discrimination display

The bottom discrimination display analyzes the bottom echo to categorize bottom hardness in one of four types (rocks, gravel, sand, mud) and shows the results in a colorful graphic display. A transducer or triducer that supports the bottom discrimination display is required.

There are two bottom discrimination displays: graphic and probability.

Graphic display: The most probable material on the bottom (mud, sand, gravel, rock) is indicated graphically.

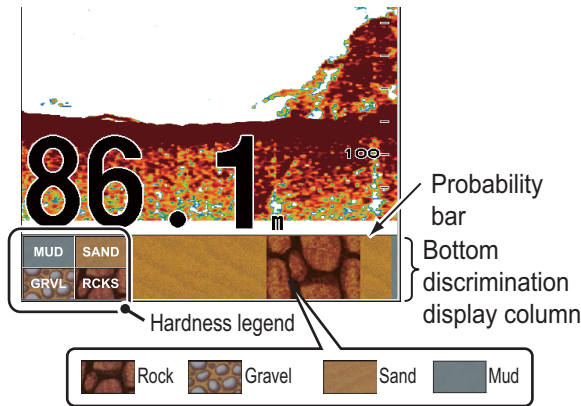

Probability bar:
Degree of trust for bottom discrimination display
(Green, Normal; Yellow, Caution;
Background color, Abnormal)

Probability display: The most probable bottom material is indicated in proportion.

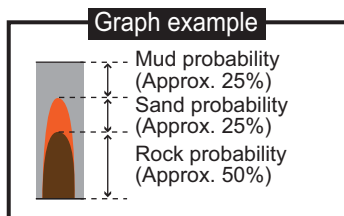
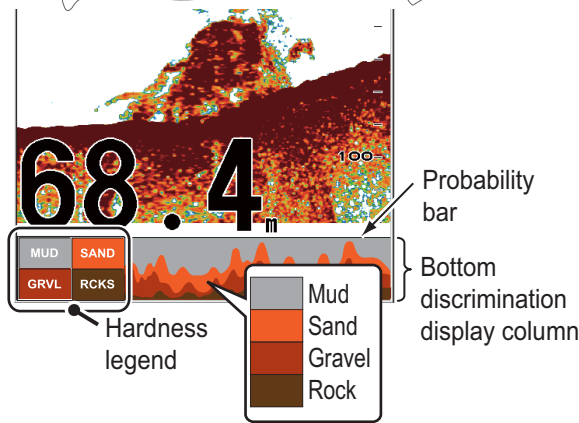

Characteristics of the bottom discrimination display

- The bottom discrimination display provides an estimate of bottom composition. Actual composition may be different.

- The 600 W transducers and triducers that support the bottom discrimination feature are 520-5PSD, 520-5MSD, 525-5PWD, 525STID-MSD, 525STID-PWD.
- The 1 kW transducers that support the bottom discrimination feature are 50/200-1T and 50/200-12M.
- The high and low frequencies are alternately transmitted, regardless of current display selection. The TX interval is slower when this feature is active.
- Operating environment:
 - Depth: 16 to 328 ft
 - Speed: 10 knots or less
- The bottom discrimination feature uses the distance from your boat's draft. Be sure to enter your boat's draft.

How to set the bottom discrimination display

1. Open the [FISH FINDER] menu and select [BOTTOM].
2. Select [BOTTOM DISCRIMINATION].
3. Select [Graphic], [Probability] or [Off].
 - [Graphic]:** Show the most probable bottom composition in four colors or graph form.
 - [Probability]:** Show the most probable bottom composition in graph form.
 - [Off]:** Turn off the bottom discrimination display.
4. Select [LEGEND].
5. Select [On] or [Off] to show or hide the hardness legend (at the bottom of the bottom discrimination display).

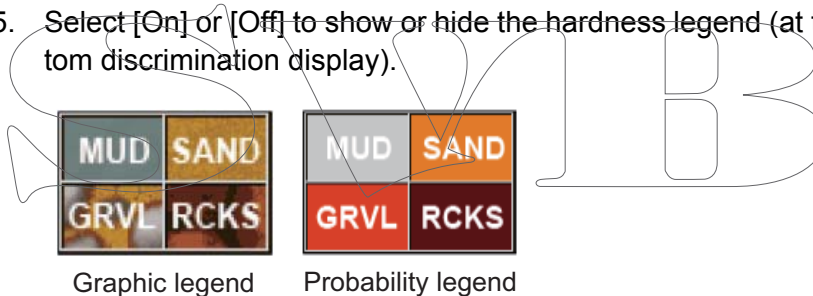

6. Press the **ESC/MENU** key to close the menu.

7.5 Automatic Fish Finder

Your fish finder can be adjusted automatically, allowing you to do other tasks.

7.5.1 How the automatic fish finder works

The automatic fish finder function automatically adjusts the gain, clutter, TVG and echo offset. The main features of the automatic mode are as shown below.

- Gain adjusts the sensitivity of the receiver to show the bottom echo in reddish-brown, the strongest echo (default color arrangement).
- Clutter automatically reduces low-level noise like plankton.
- The TVG function is automatically adjusted.
- The echo offset balances the gain on high and low frequencies.
- Range is adjusted automatically to always show the bottom echo.

7.5.2 How to select an automatic fish finder mode

There are two types of automatic fish finder modes: Cruising and Fishing. Cruising tracks the bottom, and Fishing searches for schools of fish. Cruising uses a higher clutter removal setting than Fishing. Do not use Cruising when your purpose is to find fish, because the clutter removal circuit can erase weak fish echoes.

To select an automatic mode, open the RotoKey menu then select [Auto Mode] followed by [Fishing] or [Cruising].

7.5.3 How to adjust the gain in the auto mode

The gain controls how echoes of different strengths are displayed. Gain is automatically adjusted; however, you can fine tune the gain according to meet local characteristics, etc. Set the gain to show a slight amount of noise on the screen. Increase the gain for greater depths and lower the gain for shallow waters.

To adjust the gain, open the RotoKey menu then select [Gain 50k] or [Gain 200k] followed by the soft control labeled with the frequency you want to adjust. The corresponding adjustment windows appears. Rotate the key clockwise to increase the gain, counterclockwise to decrease it.

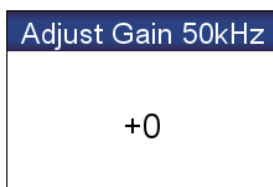

7.6 Manual Fish Finder Operation

Use the manual operation to see schools of fish and the bottom echo with a fixed gain setting.

The gain, range and range shift functions let you select the depth you can see on the screen. The basic range provides a "window" into the water column and range shift moves the "window" to the depth that you select.

To select the manual mode, open the RotoKey menu then select [Auto Mode] and [Manual].

7.6.1 How to select a display range

Range can be selected automatically or manually. Open the RotoKey menu then select [Auto Range] and [Auto] or [Manual].

[Auto]: The range is automatically adjusted to always display the bottom echo at the lower of the screen. When rotate the **RotoKey™** in the auto mode, the message "Auto Range mode. Can't change Range." appears.

[Manual]: Change the range with the **RotoKey™**. Turn the key clockwise to increase the range and counterclockwise to decrease the range.

Unit	Basic Range							
	1	2	3	4	5	6	7	8
m	5	10	20	40	80	150	300	500
ft	15	30	60	120	200	400	1000	1500
fm	3	5	10	20	40	80	150	300
HR	3	8	15	30	50	100	200	300
pb	3	5	10	30	50	100	200	300

HR=Hiro (Japanese unit of depth)
pb=passi/braza

7.6.2 How to shift the range

The basic range and range shift functions let you select the depth you can see on the screen. This function is not available when the auto range mode is on or the bottom discrimination feature is active.

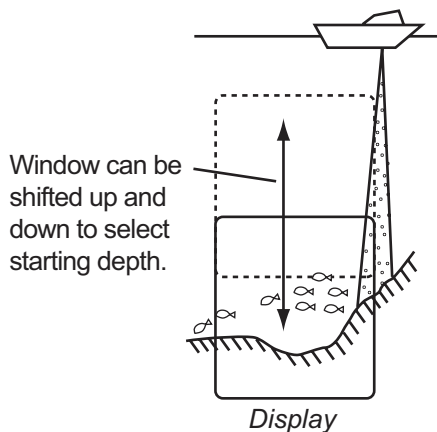

7. FISH FINDER OPERATIONS

To adjust the shift, open the full RotoKey menu then select [Shift] to show the [Shift] window. Turn the key clockwise to increase the shift, counterclockwise to decrease the shift.

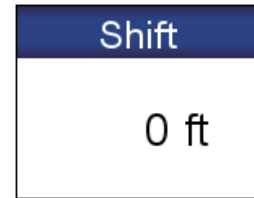

7.6.3 How to adjust the gain

The gain controls how echoes of different strengths are displayed. Set the gain to show a slight amount of noise on the screen. Increase the gain for greater depths and lower the gain for shallow waters.

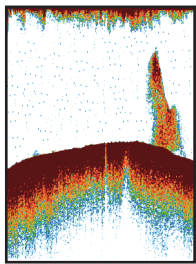

Gain too high

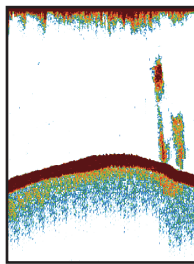

Gain proper

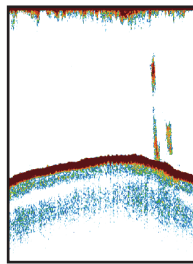

Gain too low

CAUTION



Adjust the gain correctly.

Incorrect adjustment can lead to a dangerous situation if the boat is steered according to the depth indication.

To set the gain, open the RotoKey menu then select [Gain 50 kHz] or [Gain 200 kHz] to show the [Gain] window. Turn the key clockwise to increase the gain, counterclockwise to decrease the gain. 100 is the maximum gain.

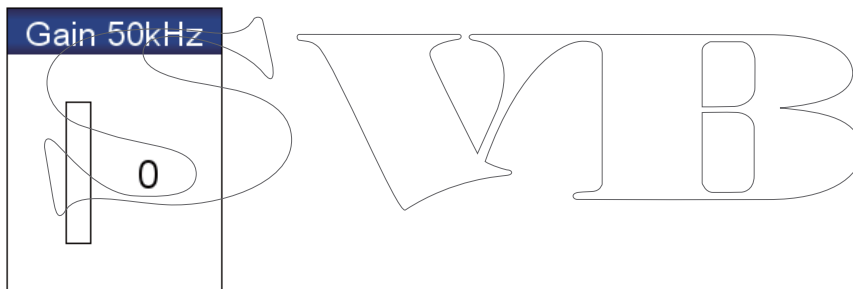

7.6.4 How to reduce clutter

Low intensity "spots" of noise appear over most of screen like in the illustration shown below. These spots of noise are caused by sediment in the water or noise.

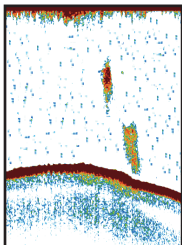

To reduce clutter, open the full RotoKey menu then select [Sensitivity] and [Clutter] to show the [Clutter] window. Turn the key clockwise adjust the clutter. Clockwise rotation increases the clutter reduction.

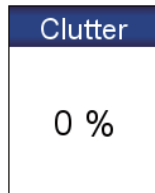

7.7 Picture Advance Speed

The picture advance speed controls how quickly the vertical scan lines move across the screen. A fast advance speed expands the size of a school of fish horizontally on the screen. A slow advance speed shortens the school of fish. Use a fast advance speed to see the hard bottom. Use a slow advance speed to see the smooth bottom.

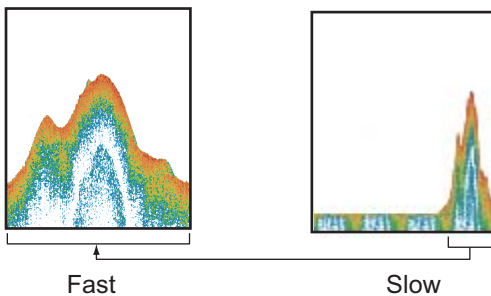

1. Open the [FISH FINDER] menu and select [PICTURE ADVANCE].
2. Select a picture advance speed. The options in the window indicate the number of scan lines made per transmission. For example, [1/2] creates one scan line per two transmissions. [1/16] is the slowest advance speed and [2/1] is the fastest speed. [STOP] stops picture advance, and is useful for taking a screenshot or photo.

STOP
1/16
1/8
1/4
1/2
1/1
2/1

	CAUTION
The picture is not refreshed when the picture advancement is stopped.	
Maneuvering the vessel in this condition can cause grounding.	

7.8 How to Reduce Interference

Interference from other fish finders and electrical equipment appears on the screen as shown in the illustration. When these types of interference appear on the screen, use the interference rejector to reduce the interference. Three levels are available. Turn off the interference rejector when there is no interference, so that you do not erase weak echoes.

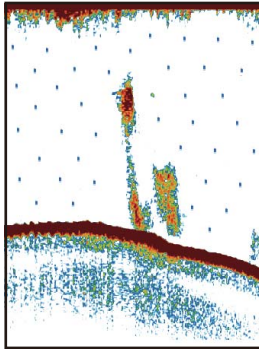

Interference from other fish finder

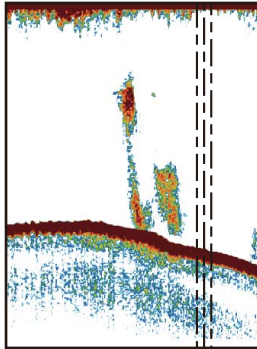

Interference from electrical equipment on your boat

To reduce interference, open the full RotoKey menu then select [Sensitivity] and [Interference] to show the [Interference] window. Select the level of interference reduction to use. [High] provides the greatest degree of interference reduction.

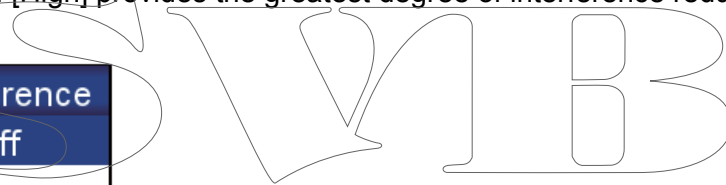
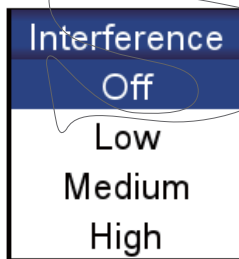

7.9 How to Erase Weak Echoes

Sediment in the water and reflections from plankton appear on the display in low-intensity colors.

To erase weak echoes, open the full RotoKey menu then select [Sensitivity] and [Color Erase] to show the [Color Erase] window. Select a low percentage to erase weak echoes. Increase the percentage to erase strong echoes.

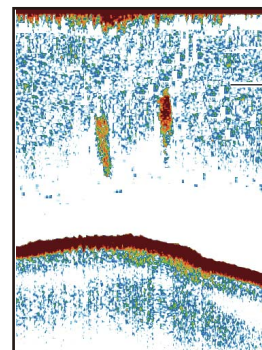

Weak echoes

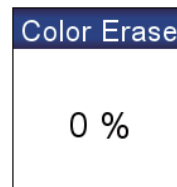

7.10 How to Measure Depth, Time Between Locations

You can measure the depth to an object with the VRM. Also, you can measure the time from the right edge to a location. For example, you can measure how many minutes ago the echo appeared.

To measure the depth, press the up and down arrow pads on the **CursorPad** to put the VRM on the object to measure the depth. To measure time, press the right and left arrow pads on the **CursorPad**.

The VRM cannot be operated when the Gain adjustment window is active.

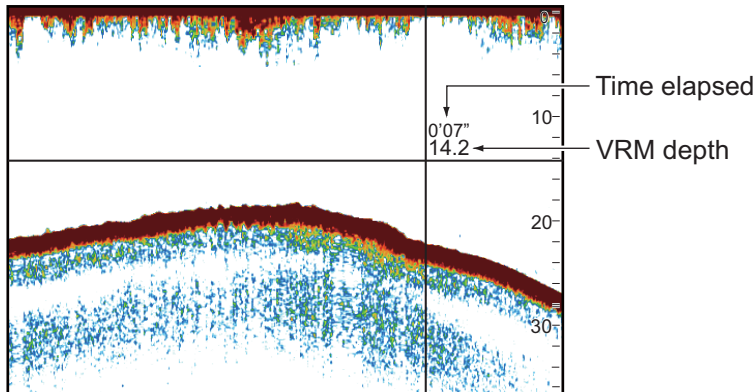

7.11 How to Balance Echo Strength

A school of fish at a depth deeper than a school of equal strength in shallow water appears in weaker colors. This condition is caused by the attenuation of the ultrasonic wave. To display the schools of fish in the same colors, use the TVG. The TVG automatically adjusts the gain with depth so that echoes of the same strength and different depths are shown in the same colors.

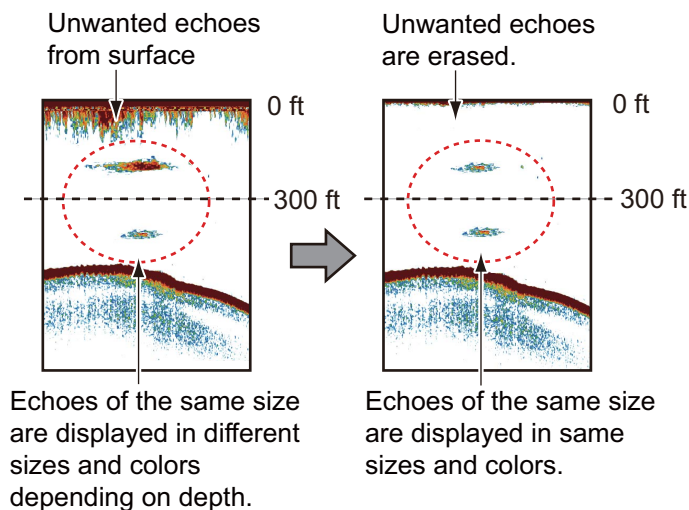

Do the following to balance echo strength:

1. Open the [FISH FINDER] menu then select [FISH FINDER SETUP].
2. Select [50 kHz TVG] or [200 kHz TVG].
3. Enter TVG value. Lower the TVG setting to decrease the gain for near distance.

4. Press the **ESC/MENU** key to close the menu.

7.12 White Marker

The white marker displays the selected echo strength in white. Use this feature to distinguish fish near the bottom from the bottom echo.

Open the full RotoKey menu then select [Sensitivity] and [White Marker] to show the [White Marker] window. Select [On]. Select the current the value, push the **RotoKey™**, rotate the key to set the echo strength number to display in white then push the key. The higher the number, the stronger echo is displayed in white. The selected color is marked in white on the color bar.

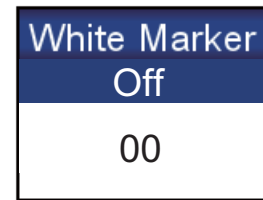

7.13 White Line

The white line feature displays the leading edge of the bottom echo in white to help you distinguish bottom fish from the bottom echo.

Open the full RotoKey menu then select [Sensitivity] and [White Line] to show the [White Line] window. Select the value, push the **RotoKey™**, rotate the key to set the width then push the key. The larger the number the greater the width of the line. Select [White Edge On] to show the contour of the bottom in white.

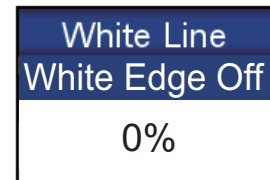

7.14 Alarms

There are four types of alarms that produce audio and visual alerts to alert you fish within an area, fish length, and bottom type.

The **fish alarm** alerts you to a school of fish in the alarm zone.

The **fish alarm (B/L)** alerts you when a fish is within the specified distance from the bottom. Available when the bottom lock display is active.

The **fish size alarm** alerts you when a fish of the specified length is in the alarm zone. Available when the ACCU-FISH™ feature is active.

The **bottom type alarm** alerts you when the bottom type (rock, sand, mud, gravel) matches both the bottom type and probability percentage selected. Available when the bottom discrimination display is active.

When the conditions of an alarm are met, the buzzer sounds and the applicable alarm icon appears at the top of the screen. Silence the buzzer by pressing the **ESC/MENU** key. The icon remains on the screen until the offending alarm is disabled or the condition that caused the alarm has ended.

7.14.1 How to set an alarm

1. Open the [ALARMS] menu and select [FISH ALARM], [FISH ALARM (B/L)], [FISH SIZE ALARM] or [BOTTOM TYPE ALARM]. An alarm setting window appears.

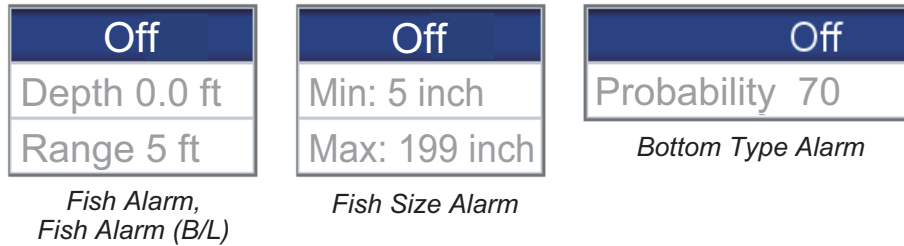

2. For the alarms other than [BOTTOM TYPE ALARM], select [On] on the first line of the alarm setting window.
3. Do one of the following depending on the alarm selected at step 1.
[FISH ALARM], [FISH ALARM (B/L)]: Set the start depth with [Depth]. Set the alarm range with [Range]. See the figure below for details.

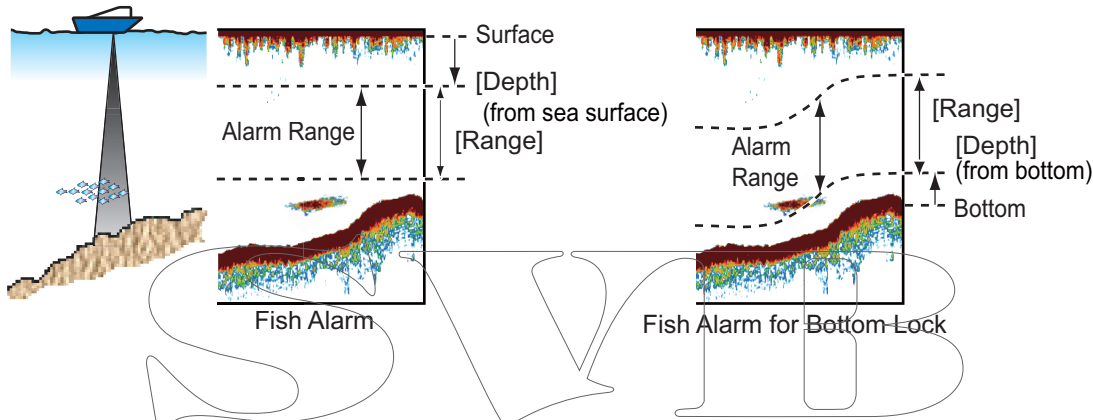

- [FISH SIZE ALARM]:** Set the minimum and maximum lengths at [Min] and [Max].
[BOTTOM TYPE ALARM]: Set the alarm referring to the illustration shown below.

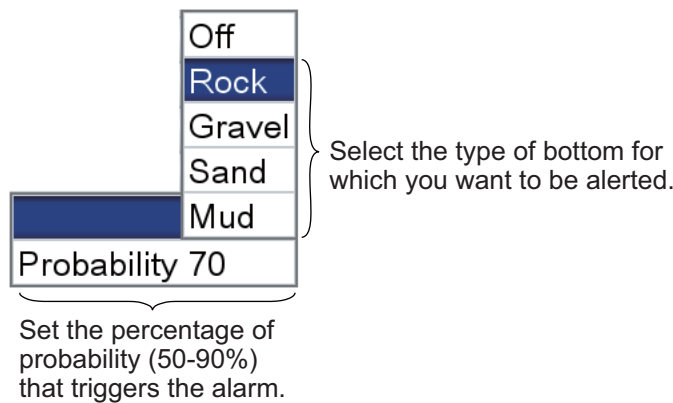

7.14.2 How to select the echo signal level that triggers the fish alarm

You can specify the echo signal level that triggers the fish alarm. Open the [ALARMS] and [FISH ALARM LEVEL] menus. Select [High], [Medium] or [Low] as appropriate.

7.15 ACCU-FISH™

The ACCU-FISH™ feature measures the length of individual fish and tags the fish with a fish symbol whose size is scaled to the length of the fish. The length or depth of the fish can be indicated digitally. Connection to a transducer that supports ACCU-FISH™ is required.

7.15.1 Considerations for ACCU-FISH™

- The fish length calculated by this fish finder is intended for reference purposes; it is not a completely accurate measurement of fish length.
- The 600 W transducers which support ACCU-FISH™ are 520-5PSD, 520-5MSD, 525-5PWD, 525STID-MSD and 525STID-PWD.
- To display fish marks and fish size using a 1 kW transducer, the integrated transducer 50/200-1T or 50/200-12M is recommended.
- Echo intensity depends on fish species. When the fish length differs between the indicated length and the actual length, you can compensate the difference on the [FISH FINDER] menu.
- ACCU-FISH™ is inoperative when the zero line rejector is active.
- High and low frequencies are alternately transmitted when ACCU-FISH™ is active, regardless of mode selection.
- A fish whose depth is shallower than 2 m or greater than 100 m cannot be measured.
- In a school of fish, echoes overlap one another, so the margin of error will be greater.
- The bottom echo must be present to show the fish symbols.
- The TX pulse length changes according to ACCU-FISH™ On/Off state. This causes a difference in both sensitivity and the echoes viewed.

7.15.2 How to activate ACCU-FISH™, select display information

1. Open the [FISH FINDER] and [ACCU-FISH] menus.

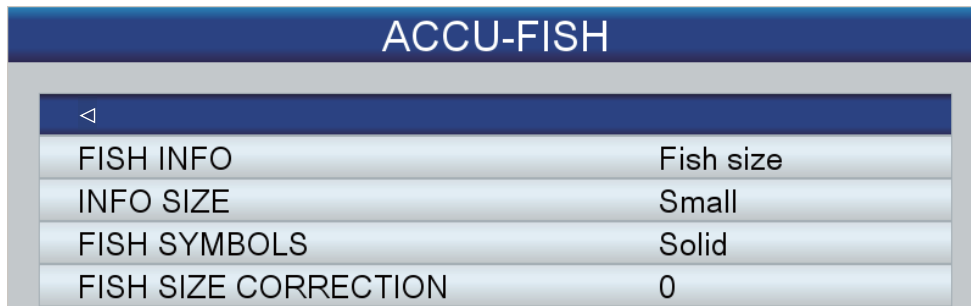

2. Select [FISH INFO] to activate or deactivate ACCU-FISH™ and select the information to display.

[Off]: Deactivate ACCU-FISH™.

[Fish Size]: Show fish size.

[Depth]: Show depth to the fish.

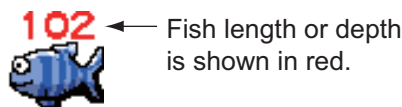

Note: You can show the fish info figure alone (without fish symbol) by turning off [FISH SYMBOLS].

3. Select [INFO SIZE] to choose the size of the fish info indication, [Small] or [Large].
4. Select [FISH SYMBOLS] to choose the style for the fish symbol, [Off], [Solid] or [Striped]. The size of the symbol is scaled according to fish length.

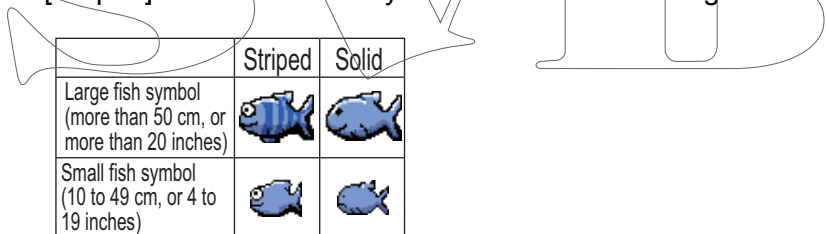

7.15.3 Fish size correction

The fish size shown on the display can be different from the true size. If the size indicated is wrong, add an offset to the measured value to get an accurate indication on the screen. Open the [FISH FINDER] and [ACCU-FISH] menus and select [FISH SIZE CORRECTION]. Use the **RotoKey™** to set a correction percentage. The setting range is -80% to +100%, in intervals of 10%.

Setting	Revised fish length
+100	Two times
+50	1.5 times
-50	1/2
-65	1/3
-75	1/4
-80	1/5

7.16 Water Temperature Graph

The water temperature graph, which requires a temperature sensor, shows the surface water temperature.

The water temperature indication (line) moves across the screen from right to left. The water temperature scale is available in degrees Celsius or Fahrenheit, one of which you can select with [TEMPERATURE] in the [UNITS OF MEASURE] menu in the [SYSTEM] menu.

You can activate or deactivate the graph with [TEMPERATURE GRAPH] in the [FISH FINDER] menu.

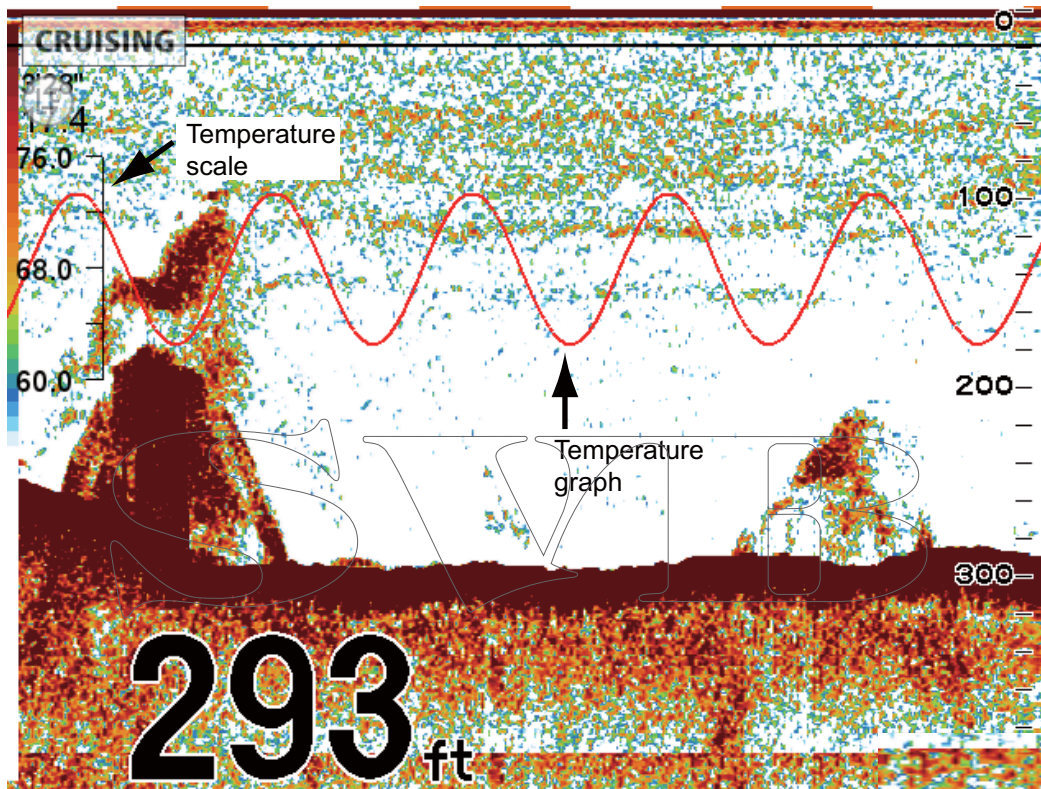

7.17 FISH FINDER Menu

This section provides the descriptions for the items in the [FISH FINDER] menu that have not been mentioned previously.

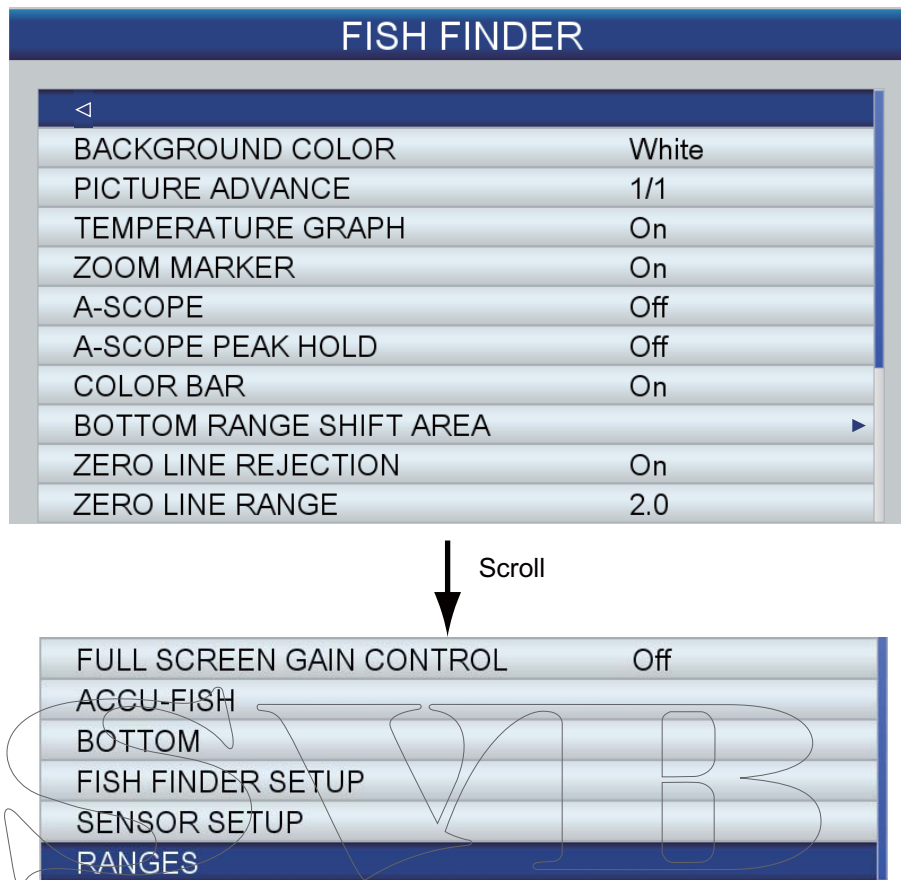

[BACKGROUND COLOR]: Select the background color, among black, dark blue, light blue, white and monochrome (echoes appear in tones of gray.)

[COLOR BAR]: Turn the color bar on or off.

[BOTTOM RANGE SHIFT AREA]: Select the area where to show the bottom echo, when Auto Range is active. For example, setting 75% would place the bottom echo at a position equivalent to 75% from the top of the display.

[ZERO LINE REJECTION]: Turn the zero line (transmission line) on or off. When turned on, the transmission line disappears, which allows you to see fish echoes near the surface clearly. The length of the transmission line changes with transducer used and installation characteristics. If the width of the transmission line is 4.5 ft (default value) or more, set the transmission line width with [ZERO LINE RANGE].

[ZERO LINE RANGE]: This feature adjusts the transmission line so that the line disappears when the menu item [ZERO LINE REJECTION] is turned on. For a long tail, increase the value. If the transmission line does not disappear, lower the TX power.

[FULL SCREEN GAIN CONTROL]: The gain setting can be applied to only new echoes or new and existing echoes. Turn this feature on to get the gain setting applied to both new and existing echoes. The advantage of the full screen gain control is that you can quickly and easily find the right gain setting for your conditions.

7. FISH FINDER OPERATIONS

[FISH FINDER SETUP]: The [FISH FINDER SETUP] sub menu provides the following features.

FISH FINDER SETUP	
TRANSMISSION	On
TRANSMISSION POWER	High
TRANSDUCER	600W
TRANSMIT RATE	
50 kHz TVG	3
200 kHz TVG	3
50 kHz ECHO OFFSET	+0
200 kHz ECHO OFFSET	+0
50 kHz BOTTOM LEVEL	+0
200 kHz BOTTOM LEVEL	+0



SMOOTHING	Off
DEPTH INFORMATION	Large

Item	Function
[TRANSMISSION]	Turn transmission on or off.
[TRANSMISSION POWER]	Set the transmission power, [High] or [Low]. Interference may appear on the screen when an echo sounder having the same frequency as your own is being operated in the vicinity of your boat. In this case, select low power and contact the other vessel to request them to reduce their TX power.
[TRANSDUCER]	Select the transducer used. If you use the optional triducer 525STID-MSD or 525STID-PWD, you do not need to select the transducer.
[TRANSMIT RATE]	Change pulse repetition rate. Normally, the highest rate (20) is used. When in shallow waters second re-reflection echoes may appear between the surface and actual bottom echo. In this case, lower the TX transmit. The [[Auto]] setting automatically adjusts the frequency and pulse length with depth.
[50 kHz ECHO OFFSET], [200 kHz ECHO OFFSET]	The echo offset feature compensates for too weak or too strong echo level. If the on-screen echo level appears to be too weak or too strong and the level cannot be adjusted satisfactorily with the gain controls, apply an offset to correct the level.

Item	Function
[50 kHz BOTTOM LEVEL], [200 kHz BOTTOM LEVEL]	In the default bottom level setting (0), the equipment judges consecutive strong echoes to be bottom echoes. If, in that setting, the depth indication is unstable, adjust the bottom level. If strong vertical lines extend upward from the bottom echo in the bottom lock display, lower the bottom level to weaken the vertical lines. If the level is too low, however, it may be difficult to distinguish bottom fish from the bottom echo.
[SMOOTHING]	If echoes appear “spotty” adjust smoothing to smooth echoes. The higher the setting the greater the smoothing.
[DEPTH INFORMATION]	Hide or show the depth indication and select its size, [Large] or [Small].

[SENSOR SETUP]: The [SENSOR SETUP] sub menu provides the following features.

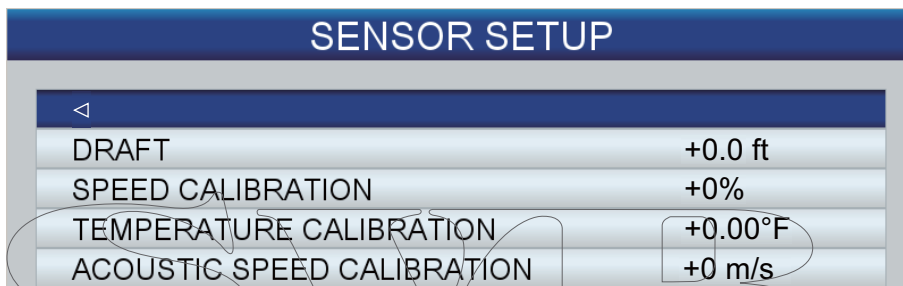

Item	Function
[DRAFT]	The default depth measurement method is the distance between the transducer and the bottom. To get the depth from the sea surface to the bottom, enter the ship’s draft. Entry of the ship’s draft is required if the bottom discrimination display is used.
[SPEED CALIBRATION]	If the speed sensor generated speed is not correct, you can add an offset to correct the on-screen speed indication. (NMEA format speed cannot be corrected.) For example, if the indication is +5% faster than the actual value, enter -5.
[TEMPERATURE CALIBRATION]	If the temperature sensor generated speed is not correct, you can add an offset to correct the on-screen temperature indication. (NMEA format temperature cannot be corrected.) For example, if the temperature indication is 2° lower than the actual value, enter +2.
[ACOUSTIC SPEED CALIBRATION]	The velocity of the acoustical pulse through water can vary depending on water conditions, which can affect the depth indication. Normally, adjustment of this setting is not necessary. If you feel the depth indication is continuously wrong, contact a FURUNO agent or dealer for advice.

7. FISH FINDER OPERATIONS

[RANGES]: The default range settings are suitable for most applications. However, you can customize the ranges to suit your needs, with [RANGE 1] - [RANGE 8]. Set the ranges in descending order. Be sure that each range is higher than its preceding range.

RANGES	
<	
RANGE 1	15 ft
RANGE 2	30 ft
RANGE 3	60 ft
RANGE 4	120 ft
RANGE 5	200 ft
RANGE 6	400 ft
RANGE 7	1000 ft
RANGE 8	1500 ft
ZOOM RANGE	30 ft
BOTTOM LOCK RANGE	30 ft

7.18 Interpreting the Display

Zero line

The zero line (transmission line) shows the position of the transducer. The line disappears from the screen when the range is shifted.

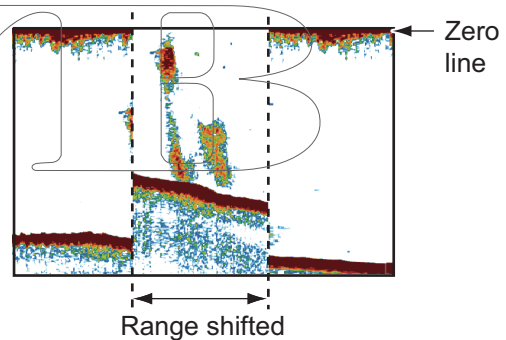

Bottom echoes

The strongest echoes are from the bottom, and are normally shown in reddish-brown or red. The colors and the width change with bottom material, depth, sea condition, installation, frequency, pulse length and sensitivity.

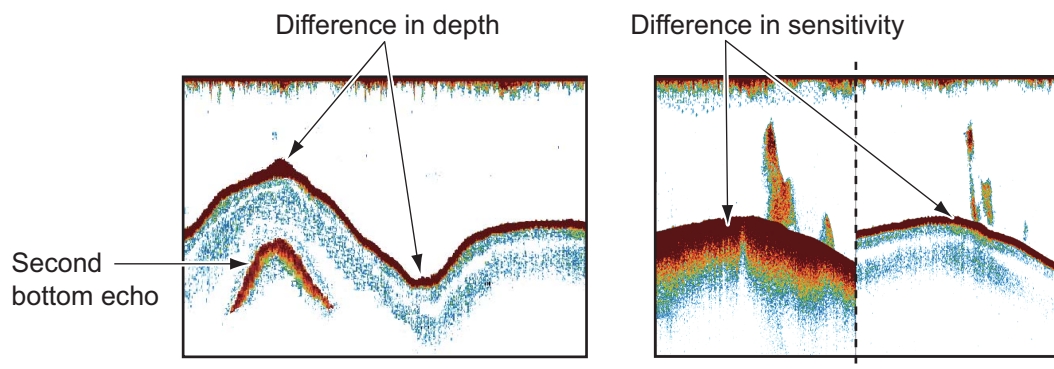

Bottom contour

The tail from a hard bottom is longer than the tail from a soft bottom, because the hard bottom reflects more of the ultrasonic pulse. An echo from shallow water gives a stronger reflection than the echo received from deep water. A longer bottom tail appears on slopes, because of the difference in travel time at both edges of the beam angle. For the rough bottom, echoes are reflected on many different planes, which displays echoes in many layers, giving a 3D effect.

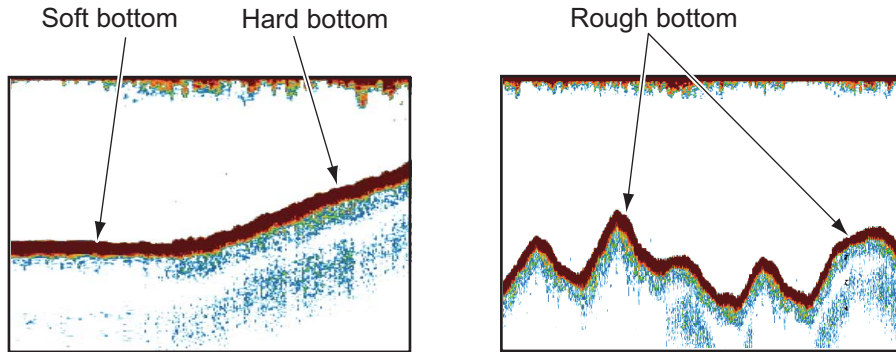

Nature of a bottom

The nature of a bottom is known from the intensity and length of the bottom tail. To find the nature of a bottom, use a long pulse length and normal gain. For the hard and rough bottom, the bottom echo is reddish-brown with a long tail. For the mud or sand bottom, the bottom echo has less red and with a short tail. A bottom with a lot of small particles can give a long tail on the low frequency picture.

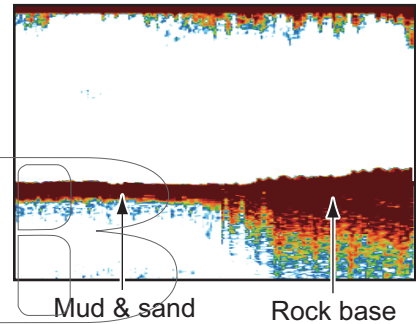

Fish quantity

The size and density of a school of fish are indicators of the quantity of fish.

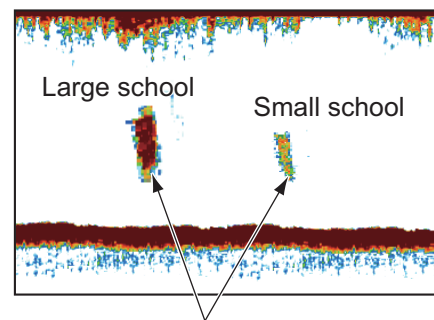

Size and density of school of fish

7. FISH FINDER OPERATIONS

Size of a school of fish

Usually the size of fish echoes on the screen is proportional to the actual size of the school of fish. However, if two fish echoes appear at different depths with the same size, the school of fish at the shallower depth is displayed smaller because the ultrasonic beam widens as it propagates and a school of fish in deep water is displayed larger.

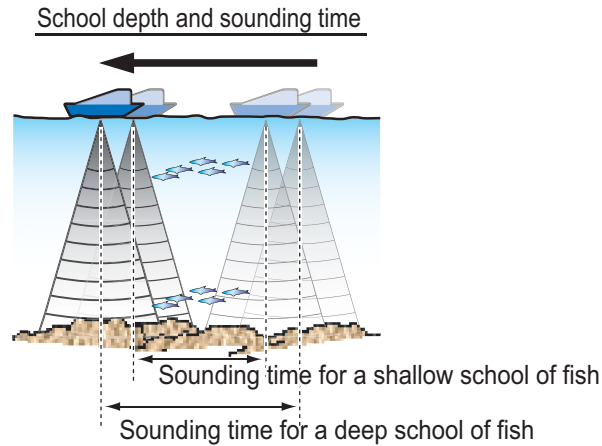

Density of a school of fish

If two schools appear with the same color at different depths, the one in deeper water is denser because the ultrasonic wave attenuates as it propagates and the school of fish in deep water tends to be displayed in a weaker color.

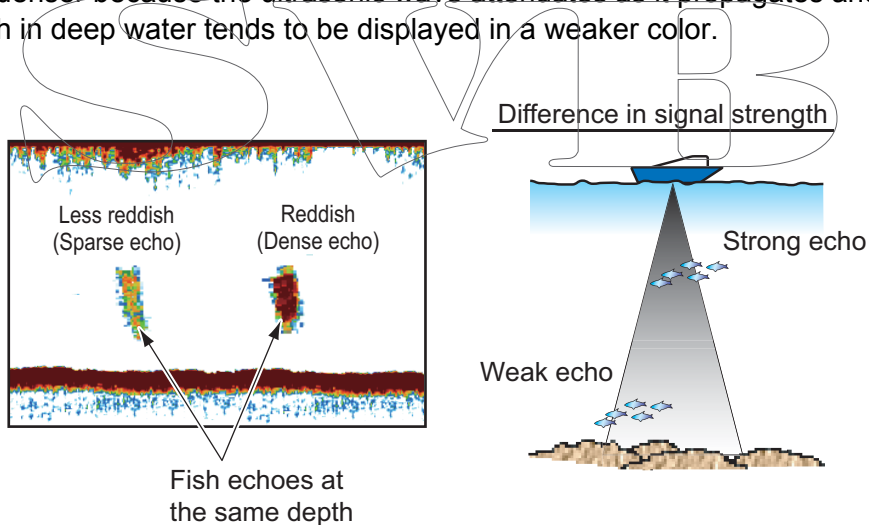

Bottom fish

The echoes from the bottom are stronger than the bottom fish echoes so that you can distinguish between them by colors. The bottom echoes are normally shown in reddish-brown or red, the bottom fish echoes in weaker color.

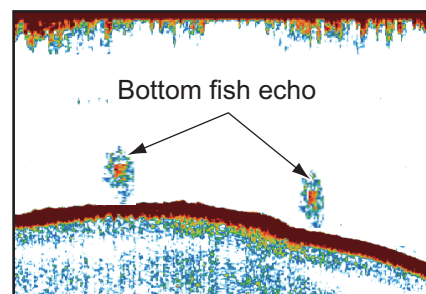

Plankton

A plankton layer appears as a large amount of green or blue dots, and is a possible location for fish. A plankton layer moves down in the day and up at night.

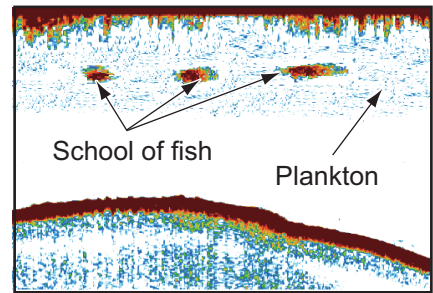

Current rip

When two ocean currents of different speeds directions and water temperatures meet, a current rip occurs. A current rip appears on the screen as shown in the right illustration.

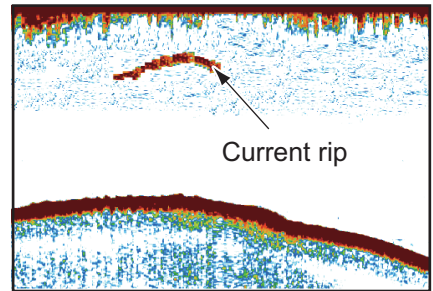

Surface noise

When the sea is rough or the ship moves over a wake, surface noise can appear at the top of the screen.

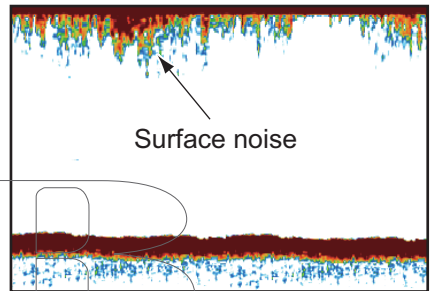

Air bubbles in the water

When the sea is rough or the ship makes a quick turn, there can be blank spots in the bottom echo (see the right illustration). These blank spots are caused by air bubbles which stop the movement of the sound wave. These air bubbles can occur with the low frequency ultrasonic waves.

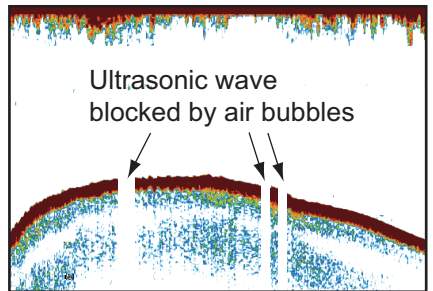

Unstable bottom echo

The bottom echoes can have a saw-tooth appearance. This occurs in heavy weather because pitching and rolling changes the direction of the ultrasonic pulses and the vertical motion of the ship causes the distance to the bottom to change.

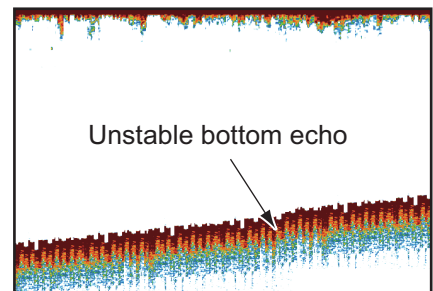

7. FISH FINDER OPERATIONS

False echo

When an ultrasonic pulse is transmitted, some energy leaves from each side of the beam. This energy has the name "sidelobe". Echoes from sidelobes show on the screen as false images like in the illustration shown below.

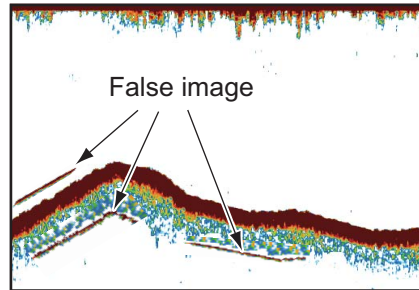
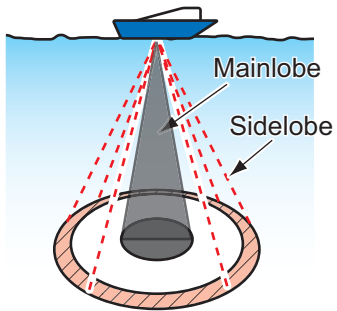

SVIB

8. ALARMS

The plotter section has 11 alarms that release audiovisual alarms when the specified conditions are met. These are

- Anchor alarm
- Arrival alarm
- Black water tank alarm
- Depth alarm
- Fuel tank alarm
- Shear alarm
- Speed alarm
- Temperature alarm
- Trip alarm
- Water tank alarm
- XTE alarm

When an alarm condition is met, the audio alarm sounds, a relevant alarm pop-up appears and the applicable alarm icon appears and flashes at the upper left-hand position. (See the Appendix for a list of the alarm icons.) You may silence the audio alarm by pressing the **ESC/MENU** key. An alarm icon remains on the screen until the corresponding alarm is deactivated or the reason for the alarm is gone.

8.1 ALARMS Menu

The [ALARMS] menu is where you set the conditions for the alarms.

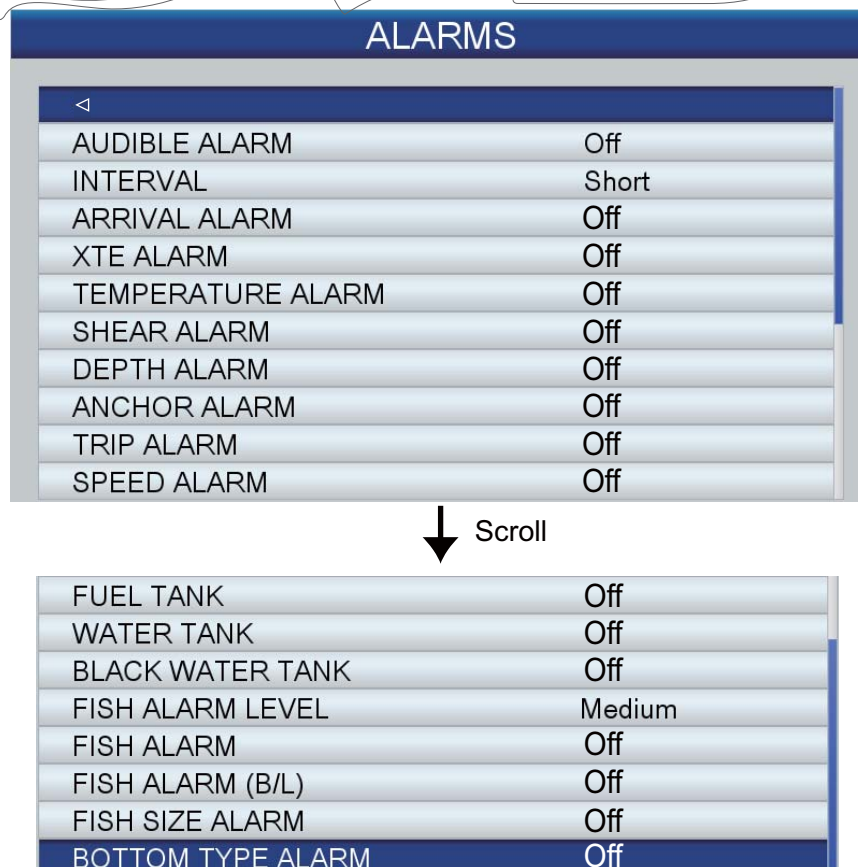

ALARMS	
<	
AUDIBLE ALARM	Off
INTERVAL	Short
ARRIVAL ALARM	Off
XTE ALARM	Off
TEMPERATURE ALARM	Off
SHEAR ALARM	Off
DEPTH ALARM	Off
ANCHOR ALARM	Off
TRIP ALARM	Off
SPEED ALARM	Off
↓ Scroll	
FUEL TANK	Off
WATER TANK	Off
BLACK WATER TANK	Off
FISH ALARM LEVEL	Medium
FISH ALARM	Off
FISH ALARM (B/L)	Off
FISH SIZE ALARM	Off
BOTTOM TYPE ALARM	Off

8.2 Audio Alarm Conditions

The audio alarm can be enabled or disabled and the alarm interval selected.

1. Open the [ALARMS] menu then select [AUDIBLE ALARM].
2. Select [Off] or [On] as appropriate.
3. Select [INTERVAL].
4. Select the alarm interval desired, among [Short] or [Long].
5. Press the **ESC/MENU** key to close the menu.

8.3 Arrival Alarm

The arrival alarm informs you that your boat is approaching a destination waypoint. The area that defines an arrival zone is that of an imaginary circle which you approach from outside the circle. The alarms will be released if your boat enters the imaginary circle. You must set a destination to use this alarm.

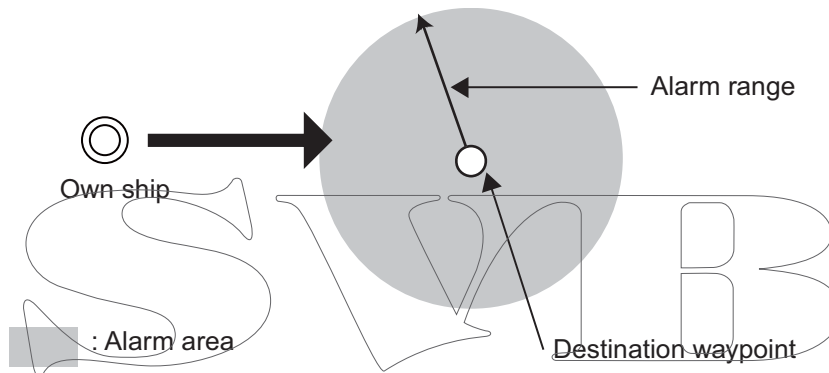

To set the arrival alarm:

1. Open the [ALARMS] menu then select [ARRIVAL ALARM].
2. Confirm that the cursor is selecting the top line then push the **RotoKey™**.
3. Select [On].
4. Set the alarm value at [Distance].
5. Press the **ESC/MENU** key to close the menu.

8.4 XTE Alarm

The XTE (cross-track error) alarm warns you when your boat is off its intended course. You must set a destination to use this alarm.

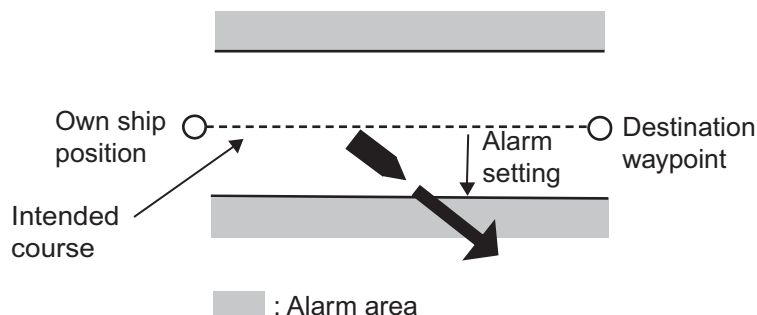

To set the XTE alarm:

1. Open the [ALARMS] menu then select [XTE ALARM].
2. Confirm that the cursor is selecting the top line then push the **RotoKey™**.
3. Select [On].
4. Set the alarm value at [Distance].
5. Press the **ESC/MENU** key to close the menu.

8.5 Temperature Alarm

The temperature alarm, which requires water temperature data, alerts you to changes in water temperature. There are two types of alarms: [Within] and [Outside]. The [Within] alarm sounds when the water temperature is within the range set, and the [Outside] alarm sounds when the water temperature is higher or lower than the range set.

To set the temperature alarm:

1. Open the [ALARMS] menu then select [TEMPERATURE ALARM].
2. Confirm that the cursor is selecting the top line then push the **RotoKey™**.
3. Select [Within] or [Outside] as appropriate.
4. Select [Min].
5. Set the minimum temperature.
6. Select [Max].
7. Set the maximum temperature.

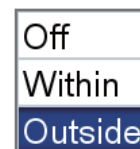

- Note:** You can switch between plus and minus with the **RotoKey™**.
8. Press the **ESC/MENU** key to close the menu.

8.6 Shear Alarm

The shear alarm, which requires water temperature data, sounds when the temperature exceeds the value set.

To set the shear alarm:

1. Open the [ALARMS] menu then select [SHEAR ALARM].
2. Confirm that the cursor is selecting the top line then push the **RotoKey™**.
3. Select [On].
4. Set the alarm value at [Range].
5. Press the **ESC/MENU** key to close the menu.

8.7 Depth Alarm

The depth alarm, which requires depth data, sounds when the depth is within the alarm range set.

To set the depth alarm:

1. Open the [ALARMS] menu then select [DEPTH ALARM].
2. Confirm that the cursor is selecting the top line then push the **RotoKey™**.
3. Select [On].
4. Select [Depth].
5. Enter the starting depth.
6. Select [Range].
7. Set the alarm range.
8. Press the **ESC/MENU** key to close the menu.

Note: When [DEPTH] in [SELECT INPUT DEVICE] in the [INTERFACE] menu is set to other than [Fish Finder], the depth alarm works according to the depth data from external equipment. The depth may not be the same as the depth indication in the fish finder display.

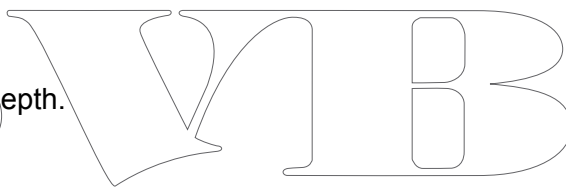

8.8 Anchor Alarm

The anchor alarm informs you that your boat is moving when it should be at rest.

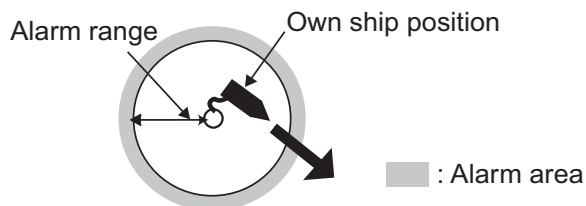

To set the anchor alarm:

1. Open the [ALARMS] menu then select [ANCHOR ALARM].
2. Confirm that the cursor is selecting the top line then push the **RotoKey™**.
3. Select [On].
4. Set the alarm value at [Distance].
5. Press the **ESC/MENU** key to close the menu.

8.9 Trip Alarm

The trip alarm alerts you when you have travelled the distance set.

To set the trip alarm:

1. Open the [ALARMS] menu then select [TRIP ALARM].
2. Confirm that the cursor is selecting the top line then push the **RotoKey™**.
3. Select [On].
4. Set the alarm value at [Distance].
5. Press the **ESC/MENU** key to close the menu.

8.10 Speed Alarm

The speed alarm tells you when the speed of your boat is within or outside the speed set.

To set the speed alarm:

1. Open the [ALARMS] menu then select [SPEED ALARM].
2. Confirm that the cursor is selecting the top line then push the **RotoKey™**.
3. Select [Within] or [Outside] as appropriate.
4. Select [Max].
5. Set the maximum speed.
6. Select [Min].
7. Set the minimum speed.
8. Press the **ESC/MENU** key to close the menu.

8.11 Fuel Tank Alarm

The fuel tank alarm warns you when the fuel level goes below the specified percentage.

To set the fuel tank alarm:

1. Open the [ALARMS] menu then select [FUEL TANK].
2. Confirm that the cursor is selecting the top line then push the **RotoKey™**.
3. Select [On].
4. Set the alarm value (5 to 50%, 5% steps).
5. Press the **ESC/MENU** key to close the menu.

8.12 Water Tank Alarm

The water tank alarm warns you when the water tank level goes below the specified percentage.

To set the water tank alarm:

1. Open the [ALARMS] menu then select [WATER TANK].
2. Confirm that the cursor is selecting the top line then push the **RotoKey™**.
3. Select [On].
4. Set the alarm value (5 to 50%, 5% steps).
5. Press the **ESC/MENU** key to close the menu.

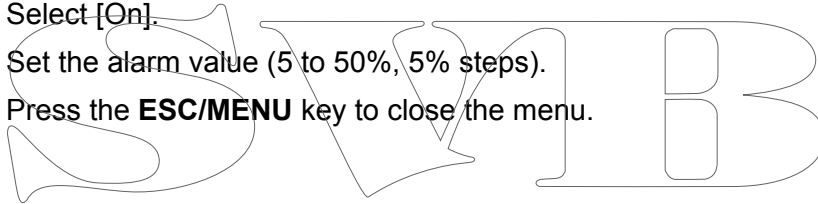

8.13 Black Water Tank Alarm

The black water tank alarm warns you when the black water tank level goes higher than the specified percentage.

To set the black water tank alarm:

1. Open the [ALARMS] menu then select [BLACK WATER TANK].
2. Confirm that the cursor is selecting the top line then push the **RotoKey™**.
3. Select [On].
4. Set the alarm value (5 to 50%, 5% steps).
5. Press the **ESC/MENU** key to close the menu.

9. MEMORY CARD OPERATIONS

This system uses SD and SDHC cards to store points, routes, tracks, settings, and screenshots. The system accepts cards of up to 32GB in size.

9.1 The Memory Card Screen

Open the [GENERAL] menu and select [MEMORY CARD] to show the [MEMORY CARD] screen. This is where all phases of memory card operations start.

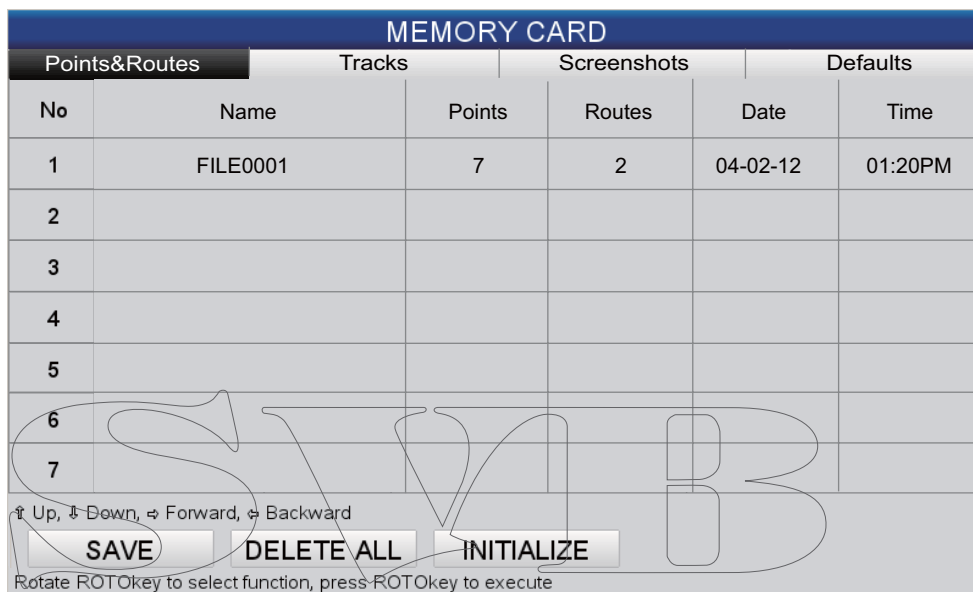

MEMORY CARD					
Points&Routes		Tracks	Screenshots		Defaults
No	Name	Points	Routes	Date	Time
1	FILE0001	7	2	04-02-12	01:20PM
2					
3					
4					
5					
6					
7					

↑ Up, ↓ Down, ⇨ Forward, ⇩ Backward

SAVE DELETE ALL INITIALIZE

Rotate ROTOkey to select function, press ROTOkey to execute

9.2 How to Initialize SD Cards

Before you can use an SD card, the card must be initialized for use with the system. You can initialize cards that contain data, in which case all information on the card is erased.

1. Open the SD card cover and insert a blank SD card in the SD card slot. Close the cover.
2. Open the [GENERAL] menu and select [MEMORY CARD].
3. Push the **ENT** key to give control to the RotoKey functions (at the bottom of the screen). Rotate the **RotoKey™** to select [Initialize] then push the key. (If the card is not a storage card, the message "It is not a user card." appears.) The message "Delete all files from SD card. Are you sure?" appears.
4. Select [YES] then push the **ENT** key. When the initialization is completed, the message "SD Card was successfully initialized." appears. Do not remove the card until the initialization is completed.
5. Press the **ESC/MENU** key to erase the message.

9.3 How to Eject an SD Card

To prevent loss of data on an SD card, eject the SD card from the RotoKey menu. Open the Full RotoKey menu then select [Eject SD]. After ejecting the SD card, close the cover.

9.4 How to Save Data to an SD Card

1. Open the [GENERAL] menu and select [MEMORY CARD].
2. Select the tab ([Point], [Route], [Track], [Screen], [Default]) corresponding to the item that you want to save.
3. Use the **RotoKey™** to select [Save] then push the key. Wait for the message "Saving completed". to appear. Do not remove the card until the message appears. Press the **ESC/MENU** key to erase the message. In the example, below the ship's tracks were saved.

The default file name is FILExxxx (xxxx=next sequential file number). If desired, you can change the name. A file name may have a maximum of 13 alphanumeric characters. See section 1.13 for how to enter alphanumeric data.

MEMORY CARD				
Points&Routes	Tracks	Screenshots	Defaults	
No	Name	Tracks	Date	Time
1	FILE0001	1	03-25-12	12:39PM

↑ Up, ↓ Down, ⇨ Forward, ⇩ Backward

SAVE DELETE ALL INITIALIZE

Rotate ROTOkey to select function, press ROTOkey to execute

9.5 How to Rename Files on an SD Card

1. Open the [GENERAL] menu and select [MEMORY CARD].
2. Select the appropriate tab at the top of the screen.
3. Select the file to rename then press the **ENT** key to show the context-sensitive menu.
4. Select [RENAME].
5. Edit the file name as appropriate, with the **CursorPad**.

9.6 How to Delete Files from an SD Card

9.6.1 How to delete individual files from an SD card

1. Open the [GENERAL] menu and select [MEMORY CARD].
2. Select the appropriate tab at the top of the screen then press the **ENT** key.
3. Select the file to delete then press the **ENT** key to show the context-sensitive menu.
4. Select [DELETE].
5. You are asked "Delete the file. Are you sure?" The [YES] button is selected; press the **ENT** key to delete the file. When the deleting is completed, the message "Deleting completed." appears. Do not remove the card until the deleting is completed. Press the **ESC/MENU** key to erase the message.

9.6.2 How to delete all files from an SD card

1. Open the [GENERAL] menu and select [MEMORY CARD].
2. Press the **ENT** key to give control to the **RotoKey™**.
3. Use the **RotoKey™** to select [DELETE ALL] then push the key
4. You are asked "Delete all files from SD card. Are you sure?" The [YES] button is selected; press the **ENT** key to delete all files. When the deleting is completed, the message "Deleting completed." appears. Do not remove the card until the deleting is completed. Press the **ESC/MENU** key to erase the message.

9.7 How to Import Data from an SD Card

You can import points, routes, track, screenshots and default settings from an SD card to the internal memory. This can be useful when you want to replace lost data or import new data from a like unit.

1. Open the [GENERAL] menu and select [MEMORY CARD].
2. Select the appropriate tab at the top of the screen then press the **ENT** key.
3. Select a file then press the **ENT** key.
4. Select [LOAD] then press the **ENT** key.
5. You are asked "Load the file. Are you sure?" The [YES] button is selected; press the **ENT** key to load the file selected.
When the loading is completed, the message "Loading completed." appears. Do not remove the card until the loading is completed. Press the **ESC/MENU** key to erase the message.

9.8 How to Process Screenshots

The [Screenshots] tab process the screenshots saved to the memory and SD cards. You can save screenshots saved in the internal memory to the SD card and delete screenshots from both the internal memory and an SD card.

9.8.1 How to select source of screenshots (internal memory or SD card)

On the [Screenshots] tab, the left button at the bottom of the screen, operated with the **RotoKey™**, toggles the source of screenshots between the internal memory and SD card. The selected source is indicated at the top left corner, as [[INTERNAL] or [SD CARD].

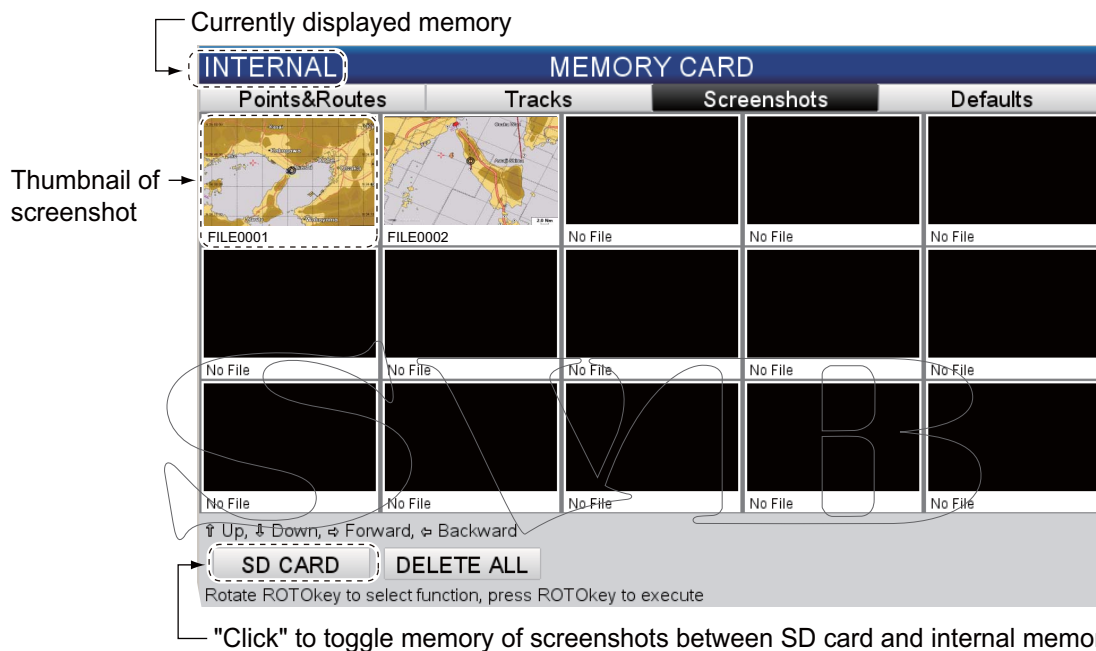

9.8.2 How to save screenshots in the internal memory to an SD card

1. Open the [GENERAL] menu and select [MEMORY CARD].
2. Select the [Screenshots] tab at the top of the screen then press the **ENT** key.
3. If the indication at the top left corner is [SD CARD], push the **RotoKey™** with [INTERNAL] selected at the bottom of the screen.
4. Select a screenshot then press the **ENT** key.
5. Select [SAVE] then press the **ENT** key.
6. When the saving is completed, the message "Saving completed." appears. Do not remove the card until the saving is completed. Press the **ESC/MENU** key to erase the message.

9.8.3 How to delete screenshots

How to delete individual screenshots

1. Open the [GENERAL] menu and select [MEMORY CARD].
2. Select the [Screenshots] tab at the top of the screen then press the **ENT** key.
3. Select the SD card or internal memory as applicable. See section 9.8.1.
4. Select the screenshot to delete then push the **ENT** key to show the context-sensitive menu.
5. Select [DELETE].
6. You are asked "Delete the file. Are you sure?" The [YES] button is selected; push the **ENT** key to delete the file selected. When the deleting is completed, the message "Deleting completed." appears. Do not remove the card until the deleting is completed. Press the **ESC/MENU** key to erase the message.

How to delete all screenshots

1. Open the [GENERAL] menu and select [MEMORY CARD].
2. Select the [Screenshots] tab at the top of the screen then press the **ENT** key.
3. Select the SD card or internal memory as applicable. See section 9.8.1.
4. Use the **RotoKey**TM to select the [DELETE ALL] button (at the bottom of the screen) then push the key
5. You are asked "Delete all files from Internal Memory. Are you sure?" or "Delete all files from SD card. Are you sure?" The [YES] button is selected; push the **ENT** key to delete all files from the source selected. When the deleting is completed, the message "Deleting completed." appears. Do not remove the card until the deleting is completed. Press the **ESC/MENU** key to erase the message.

9. MEMORY CARD OPERATIONS

This page is intentionally left blank.

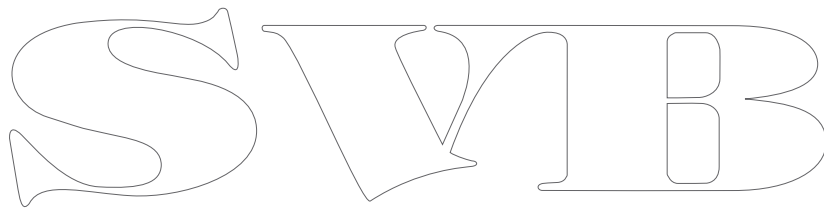
A large, hollow outline of the letters "SWIB" in a stylized, serif font. The letters are arranged horizontally and are centered on the page.

10. OTHER FUNCTIONS



10.1 AIS Operations

AIS (Automatic Identification System) is a system that continuously transmits the identification and position of your boat to AIS transponder equipped vessels within communicating range. All such vessels also receive data from other AIS transponder equipped vessels and display their positions and other relevant information. The AIS broadcasts this information over a VHF transceiver. Data include:

- Position
- Call sign
- Name of vessel
- Speed over the ground
- Course over the ground
- CPA
- Heading
- MMSI no.
- TCPA

A maximum of 200 targets can be displayed, in the order in which they are received. Connection to a Class A or B AIS transponder is required.

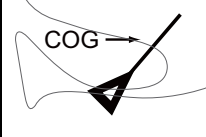
10.1.1 AIS target symbols

Symbol	Target category	Color	Description
	AIS target	White	COG is indicated with a solid line.
	Dangerous AIS target	White (flashing)	An AIS target is declared a dangerous target when its CPA and TCPA put the target on a collision course with your boat.
	Lost AIS target	White	An AIS target becomes a lost target if a signal is not received from the AIS target for x* minutes. The lost target symbol is erased if a signal is not received for an additional x* minutes. *The time depends on the AIS transponder. Check your AIS owner's manual for details.

The symbols of AIS targets out of the display range are displayed smaller.

10.1.2 How to find AIS target information

Put the cursor on an AIS target symbol to show AIS target information.

AIS Information	
Name	FURUNO
Latitude	34°39.0413N
Longitude	135°21.8571E
MMSI	456342110
Call Sign	1AB23
SOG	15.3 kn
COG	234°T
HDG	235°T
CPA	3.28 NM
TCPA	00:11:40

10.1.3 AIS activation range

The default AIS activation range is 5.0 nm. Any AIS target that is within 5.0 nm of your boat is automatically activated. If you require a shorter or longer activation range, you can change the range from the menu. Open the [SYSTEM] menu and select [AIS SET-UP]. Select [ACTIVATION RANGE] and enter the range desired. (Note that tracking continues internally on a maximum of 200 targets within 50 nm.)

10.1.4 CPA and TCPA alarms

The CPA alarm sounds when an AIS transponder equipped vessel comes within the CPA alarm range set. The TCPA alarm alerts you when an AIS transponder equipped vessel is within the time you specify.

Do the following to set the CPA and TCPA alarms:

1. Open the menu then open the [SYSTEM] and [AIS SETUP] menus.
2. Select [CPA ALARM] or [TCPA ALARM] as appropriate.



CPA alarm setting window



TCPA alarm setting window

3. Line 1 in the window is selected; push the **RotoKey™** then select [On].
4. Set the range (CPA alarm) or time of closest approach (TCPA alarm) on line 2.
5. Press the **ESC/MENU** key to close the menu

10.2 DSC Message Information

The DSC (Digital Selective Calling) message information feature alerts you when you have received a DSC position request or a DSC distress call, via an SSB radiotelephone. The  icon marks the position of the vessel that sent the request or call on the plotter display, at the time the message was sent. The cursor is put on that position.

If you are not on the plotter display, the message shown below appears. Select [YES] if you want to go to the plotter display.



This feature requires connection of a DSC capable radiotelephone that outputs the PGN format DSC sentence (129808).

10.2.1 How to select a device for DSC message information

Open the [INTERFACE] menu and select [SELECT INPUT DEVICE]. Select a model name in [DSC].

10.2.2 DSC message information

When a DSC message is received, the DSC icon appears on the display, at the position when the message was transmitted. The max. 20 DSC icons are saved. When the capacity for icons is reached, the oldest icon is automatically erased to make room for the latest mark. To see information about the message, put the cursor on the icon. The example below shows the information shown for a distress call.

Name of vessel and date and time of transmission	DISTRESS CALL	
	VOYAGER 02/13/12 08:10PM	
Position of vessel at time of transmission	43°59.2157'N	
	135°16.6498'E	
	DST NM	BRG T
	10.5	185°
	Distance and bearing to position at time of transmission	

10.3 Stopwatch, Timer

A stopwatch or timer is available on a navigation data display. (The stopwatch and timer cannot be used simultaneously.) The stopwatch counts elapsed time and the timer counts down the time from a specified time interval. To enable the stopwatch or timer, do the following.

How to show the timer or stopwatch display

1. Display a home screen that has a quarter screen or a half screen with navigation data. If you do not currently have one, make one referring to section 1.8.
2. Long press the **HOME/CTRL** key to select a data display where to show the timer or stopwatch display. The selected indication is circumscribed with a red rectangle.
3. Open the RotoKey menu then choose [Select Data].
4. Rotate the **RotoKey™** to select the location where to put the timer or stopwatch then push the **RotoKey™**. The [Select Data] window, shown in the right figure, appears.
5. Select [Stopwatch] followed by [TIMER] or [WATCH].

Select Data
<
Navigation
Speed/Bearing
Depth
Environment
Wind
Engine 0
Engine 1
Engine 2
Stopwatch

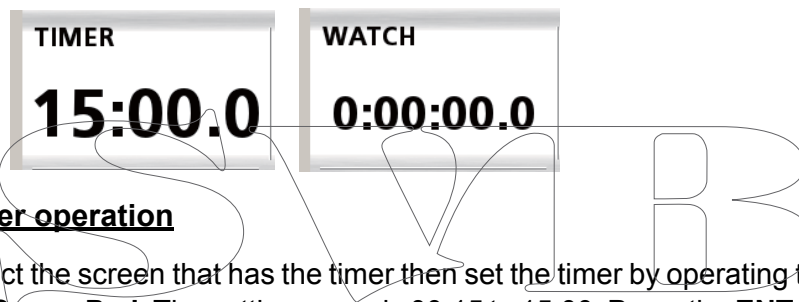

Timer operation

Select the screen that has the timer then set the timer by operating the down arrow on the **CursorPad**. The setting range is 00:15 to 15:00. Press the **ENT** key to start or stop the timer. The beep(s) sound(s) at the following times:

- When the remaining time is 10, 5, 4, 3, 2, or 1 minute(s), two beeps sound.
- When the remaining time is 30 seconds, three beeps sound.
- When the remaining time is 10 seconds, one beep sounds every second.
- When the count is 0, one long beep sounds for a second.

To restart the timer from the time set, open the RotoKey menu then select [Reset].

Stopwatch operation

To start or stop the stopwatch, select the screen that has the stopwatch then press the **ENT** key. To reset the stopwatch to zero, open the RotoKey menu then select [Reset].

10.4 How to Select Input, Output Data

Select the data to receive and output. Before selecting data to output, confirm what data the external equipment requires. Output necessary data only. Outputting unnecessary data can cause receiving problems at the external equipment.

10.4.1 Input data

Open the [INTERFACE] menu and select [SELECT INPUT DEVICE].

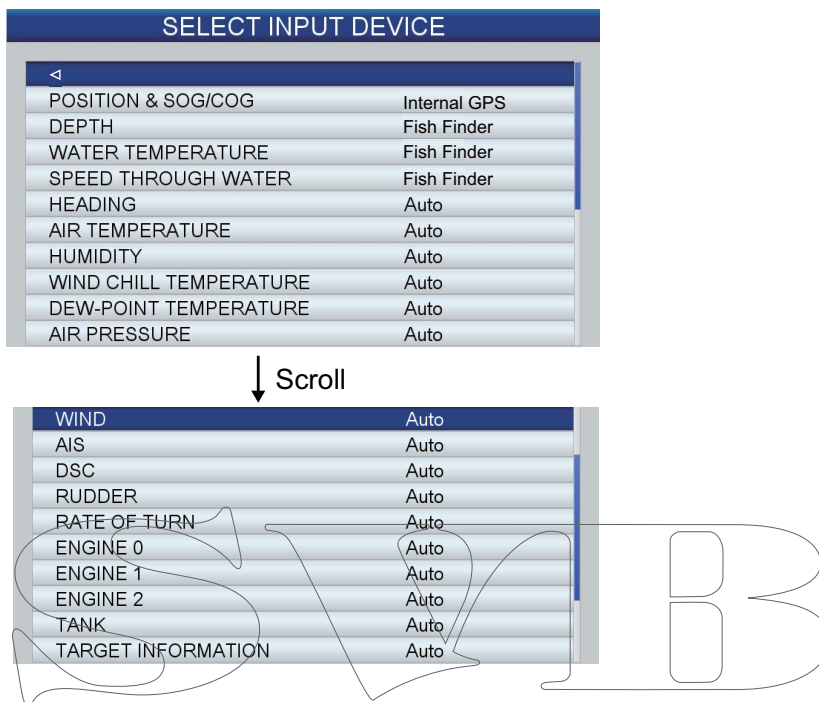

Select the item to process then push the **RotoKey™**. Do one of the following depending on your selection.

Item	Options
[POSITION & SOG/COG]	[Internal GPS]: Use the internal GPS navigator. [Auto]: Select if you have multiple navigators connected and you want to use them instead of the internal GPS navigator. If the external source is a FURUNO make, its name appears below [Auto]. Select it to have that device feed respective data.
[DEPTH], [WATER TEMPERATURE] and [SPEED THROUGH WATER]	[Fish Finder]: Select to have the internal fish finder feed respective data. [Auto]: Select when multiple external sources are available and you want to use them instead of the internal fish finder. In this case, the device with the lowest IP address has priority. If the external source is a FURUNO make, its name appears below [Auto]. Select it to have that device feed respective data.
Other items	Select [Auto] in case of multiple sources, or the FURUNO device name that appears below [Auto], if a FURUNO device is connected.

10.4.2 Output data

Open the [INTERFACE] menu and select [SELECT OUTPUT PGN]. Select the item to process. Select [On] or [Off] as appropriate.

SELECT OUTPUT PGN	
<	
126992 (SYSTEM TIME)	On
127258 (MAGNETIC VARIATIONS)	On
128259 (SPEED)	On
128267 (WATER DEPTH)	On
128275 (DISTANCE LOG)	On
129025 (POSITION RAPID UPDATE)	On
129026 (COG & SOG RAPID UPDATE)	On
129029 (GNSS POSITION DATA)	On
129033 (TIME AND DATE)	On
129283 (CROSS TRACK ERROR)	On



129284 (NAVIGATION DATA)	On
129285 (NAVIGATION - ROUTE/WP)	On
130310 (ENVT. PARAMETERS)	On
130312 (TEMPERATURE)	On
130830 (TARGET INFORMATION)	On
130831 (BOTTOM CLASSIFICATION)	On
130832 (FISH LENGTH)	On

10.5 Engine Display Setup (INSTRUMENTS menu)

Set your engine's specifications on the [INSTRUMENTS] menu to get correct information on the engine displays.

INSTRUMENTS	
ENGINE RPM	6000RPM
MAX OIL PRESSURE	800kPa
ENGINE BOOST PRESSURE	200kPa
ENGINE COOLANT PRESSURE	520kPa
FUEL PRESSURE	520kPa
ENGINE TEMPERATURE	80° to 320°F
ENGINE OIL TEMPERATURE	80° to 320°F
TRANSMISSION TEMPERATURE	80° to 320°F

Item	Options	Remarks
ENGINE RPM	4000, 6000, 8000 rpm	Set max. rpm.
MAX OIL PRESSURE	600kPa/6Bar/80Psi 800kPa/8Bar/120Psi 1000kPa/12Bar/160Psi	Set max. oil pressure
ENGINE BOOST PRESSURE	160kPa/1Bar/24Psi 200kPa/2Bar/32Psi 320kPa/4Bar/40Psi	Set engine boost pressure rating.
ENGINE COOLANT PRESSURE	320kPa/2Bar/48Psi 520kPa/4Bar/64Psi 600kPa/6Bar/96Psi	Set engine coolant pressure rating.
FUEL PRESSURE	320kPa/2Bar/48Psi 520kPa/4Bar/64Psi 600kPa/6Bar/96Psi	Set fuel pressure rating.
ENGINE TEMPERATURE	30 to 150°C/80 to 320°F 50 to 210°C/120 to 400°F	Set engine temperature range.
ENGINE OIL TEMPERATURE	30 to 150°C/80 to 320°F 50 to 210°C/120 to 400°F	Set engine oil temperature range.
TRANSMISSION TEMPERATURE	0 to 150°C/80 to 320°F 50 to 210°C/120 to 400°F	Set transmission temperature range.

This page is intentionally left blank.

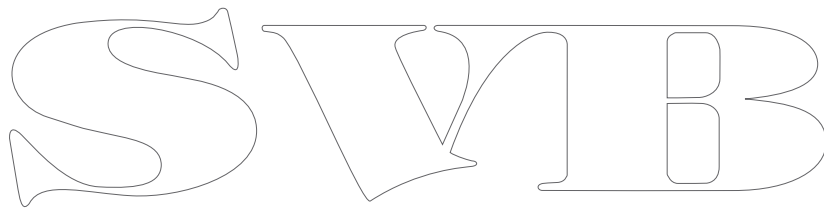
A large, hollow outline of the letters "SWIB" in a stylized, serif font. The letters are arranged horizontally and are centered on the page. The outline is thin and black, with no fill.

11. CUSTOMIZING YOUR UNIT

The default settings are suitable for a wide variety of applications. However, you may wish to customize settings to meet your environment, operational needs, local characteristics, etc. This chapter provides descriptions of the menu items not previously described, to help you determine the settings right for you.

11.1 GENERAL Menu

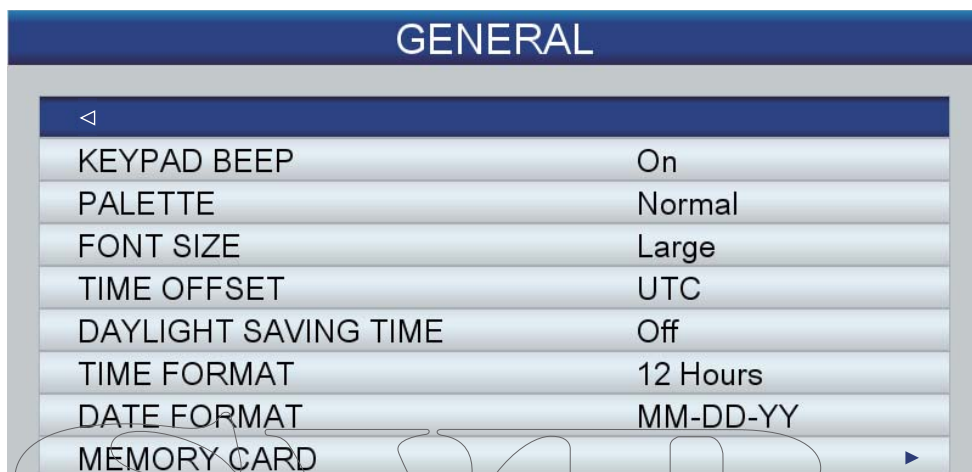

[KEYPAD BEEP]: Activate or deactivate the key beep which sounds when a key (incl. RotoKey™) is operated.

[PALETTE]: Select the color scheme to use, [SunLight], [Night] or [Normal].

[FONT SIZE]: Set the font size, large or small, for the main menu, context-sensitive menu and information windows. The font in the data boxes, RotoKey menu and indications on the map is not adjustable.

[TIME OFFSET]: The time fed from the GPS satellites is UTC. To use local time, enter the time difference between UTC and local time.

[DAYLIGHT SAVINGS TIME]: Turn on when your area uses daylight saving time.

[TIME FORMAT]: Select the time display format, 12 hour or 24 hour.

[DATE FORMAT]: Select the date display format, MM-DD-YY or DD-MM-YY.

11.2 PLOTTER Menu

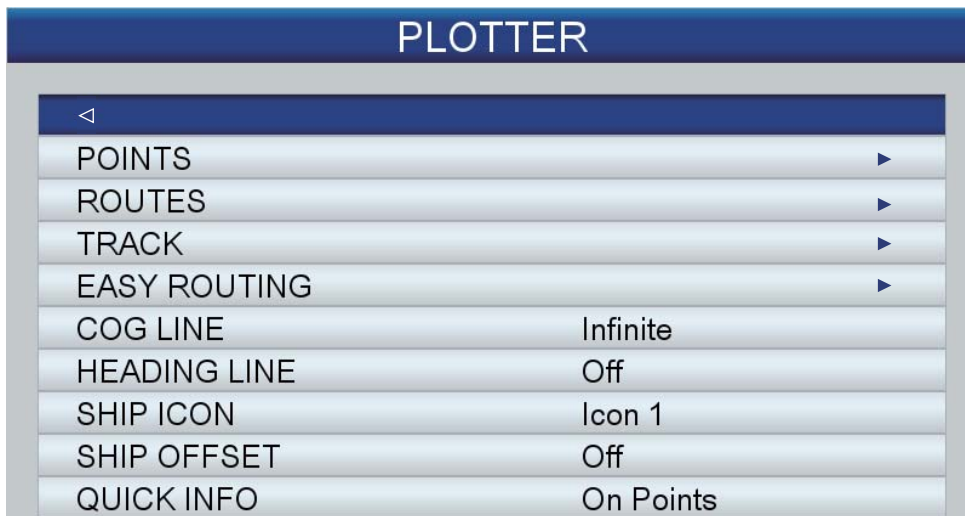

[COG LINE]: The tip of the COG line is your estimated position at the end of the time interval selected here. The COG line can be a valuable tool for evaluating the risk of collision with another vessel if AIS targets are displayed. A target whose vector passes through your ship's position is on a collision course. The [Infinite] option extends the line to the edge of the screen.

[HEADING LINE]: Show or hide the heading line.

[SHIP ICON]: You can display the ship icon in one of three configurations.

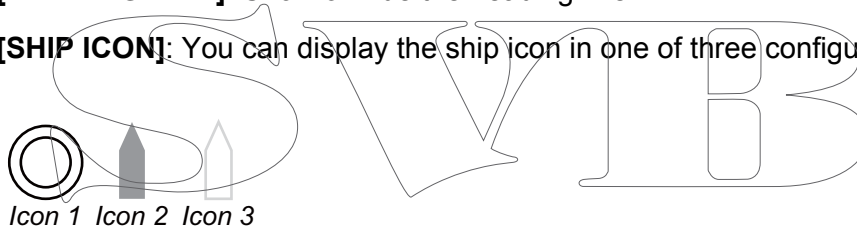

[SHIP OFFSET]: Activate or deactivate the ship offset feature. The ship icon is automatically moved to the opposite position on screen based on your boat's course when the icon nears the edge of the screen while you scroll the chart. In the illustration below, for example, the ship icon is placed at the bottom 1/4 of the screen because the ship icon is nearing the upper right edge of the screen.

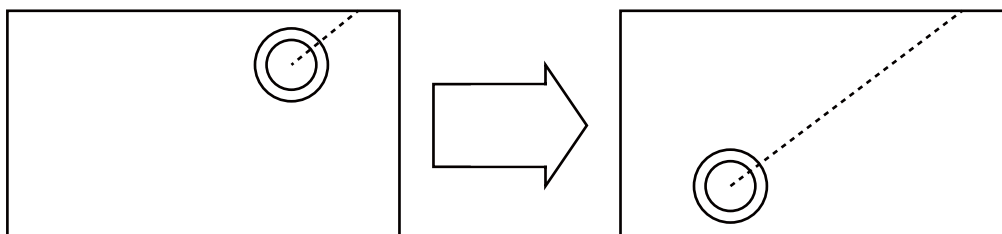

[QUICK INFO]: Select what objects to show quick information for.

[On Points]: Show quick information for points (chart objects, points, routes, track).

[On All]: Show quick information for anything selected with the cursor

[Off]: Turn off the quick information feature.

11.3 SYSTEM Menu

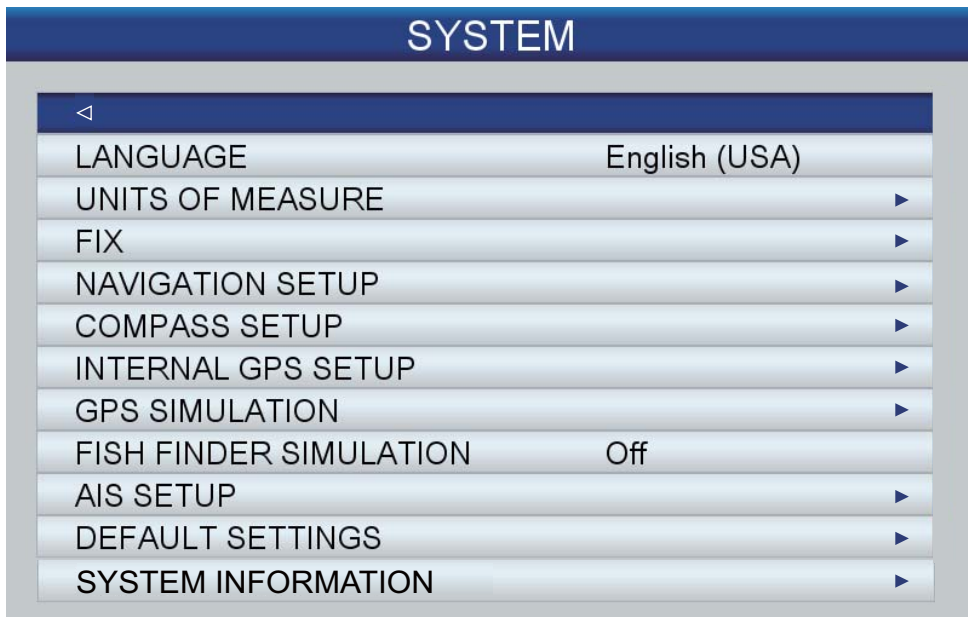

[LANGUAGE]: Select the language among English and major European and Asian languages.

[UNITS OF MEASURE]: The default units of measure are based on the language selected. However, you can freely set the units of measure for distance, speed, wind speed, depth, fish size, temperature, air pressure, oil pressure, and fuel.

Item	Available units
Distance	NM, SM, KM, NM+ft, NM+m, SM+ft
Speed	kn, mph, km/h
Wind Speed	kn, m/s, mph, Bft
Depth	m, ft, fm, pb, HR
Fish Size	inch, cm
Temperature	°C, °F
Air Pressure	Bar, hPa
Oil Pressure	Bar, PSI, kPa
Fuel	l, UK gal, US gal

[FIX]: Provides for adjustment of the GPS position.

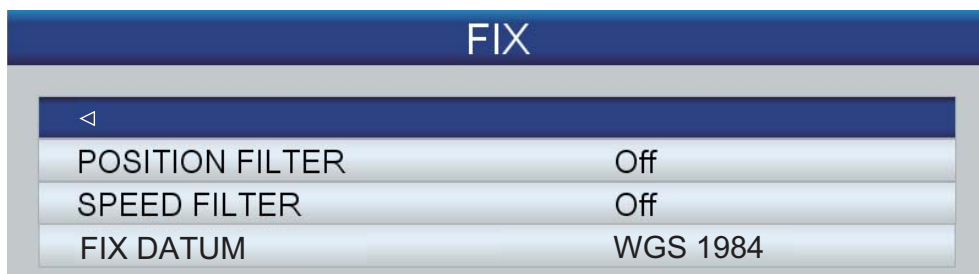

[POSITION FILTER]: When the DOP or receiving condition is unfavorable, the GPS fix may change, even if the vessel is dead in water. This change can be reduced by smoothing the raw GPS fixes. You can choose the setting from among [Off], [Low], [Medium] and [High]. The higher the setting, the more smoothed the raw data, however too high a setting slows response time to change in latitude and longitude. This is especially noticeable at high ship's speeds. [Off] is the “normal” setting; increase the

11. CUSTOMIZING YOUR UNIT

setting if the GPS fix changes greatly.

[SPEED FILTER]: During position fixing, ship's velocity (speed) is directly measured from the GPS satellite. The raw velocity data may change randomly depending on receiving conditions and other factors. You can reduce this random variation by increasing the filter setting. Like with the latitude and longitude filter, the higher the speed filter setting the more smoothed the raw data. If the setting is too high, however, the response to speed and course change slows. For no smoothing, choose Off.

[FIX DATUM]: Select the datum used to prepare your chart.

[NAVIGATION SETUP]: Navigate provides for customizing of the map display.

NAVIGATION SETUP	
<<	
COORDINATE SYSTEM	ddd mm.mmmm
MAP DATUM	WGS 1984
ROTATION THRESHOLD	30

[COORDINATE SYSTEM]: Select the coordinate display method, among ddd mm.mmm, ddd mm.mmmm, or ddd mm ss.

[MAP DATUM]: Select the datum.

[ROTATION OF THRESHOLD]: Sets the amount of course (in degrees) that initiates redrawing of the course in the Auto course-up mode.

[COMPASS SETUP]: Select the type of compass used and set magnetic variation.

COMPASS SETUP	
<	
BEARINGS	True
VARIATION	Auto

[BEARINGS]: Select True for gyrocompass, Magnetic for magnetic compass.

[VARIATION]: The location of the magnetic north pole is different from the geographical north pole. This causes a difference between the true and magnetic north location. This difference is called magnetic variation, and varies with respect to the observation point on earth. Your unit is preprogrammed with all the earth's magnetic variations. However, you may wish to enter variation manually, referring to a nautical chart, to refine accuracy. Set to [AUTO] to get correct variation when there is no position data.

[INTERNAL GPS SETUP]: Set up the internal GPS receiver.

INTERNAL GPS SETUP	
<	
RESTART GPS	
NAVIGATION SPEED	High
DIFFERENTIAL CORRECTION	Off

[RESTART GPS]: Restart reception of GPS satellites.

[NAVIGATION SPEED]: Set different dynamic platform models to adjust the navigation engine to the expected application environment. [Low] corresponds to pedestrian dynamic platform model. For applications with low acceleration and speed. [High] corresponds to at sea dynamic platform model. Recommended for applications at sea.

[DIFFERENTIAL CORRECTION]: Turn GPS differential correction on or off. The correction is made with SBAS (WAAS, EGNOS, MSAS).

[GPS SIMULATION]: Set up the GPS simulator.

GPS SIMULATION	
<	
SIMULATION MODE	Off
COURSE	0°
SPEED	1.0 kn
DATE	03-16-12
TIME	12:00PM
CURSOR CONTROL	Off

[SIMULATION MODE] activates or deactivates the GPS simulation mode. Set the course, speed, date and time. [CURSOR CONTROL] allows control of the simulation speed and course with the arrow keys. Use the up and down arrows to control speed; the right and left arrows to control course.

[FISH FINDER SIMULATION]: Activate or deactivate the fish find simulator. [Demo1] is a shallow water simulator and [Demo2] is a deep water simulator.

This page is intentionally left blank.

The image shows the letters 'S', 'W', 'I', and 'B' in a large, stylized, outlined font. The letters are white with a black outline and are arranged horizontally. The 'S' is on the left, followed by 'W', 'I', and 'B' on the right. The font is a decorative, serif style.

12. MAINTENANCE, TROUBLESHOOTING

This section provides maintenance and troubleshooting procedures that the user can follow to get optimum performance from the equipment. Before attempting any maintenance or troubleshooting procedure please review the safety information below. If you cannot restore normal operation after following the troubleshooting procedures do not attempt to check inside the equipment; have a qualified technician check the set.

⚠ WARNING



ELECTRICAL SHOCK HAZARD
Do not open the equipment.

Only qualified personnel can work inside the equipment.

IMPORTANT

Do not apply paint, anti-corrosive sealant or contact spray to coating or plastic parts.

Those items contain organic solvents that can damage coating and plastic parts, especially plastic connectors.

12.1 Maintenance

Check the items shown in the table below regularly to prevent unnecessary trouble.

Check item	Check point	Remedy
Antenna unit	Check for loosened and corroded bolts.	Tighten loosened bolts. Replace heavily corroded bolts.
Cable	Check that cables are tightly fastened, free of corrosion and not damaged.	Connect cable if it has loosened. Replace damaged cables.
Display unit connector	Check if tightly fastened.	Fasten if loosened.
Ground	Check for tight connection and rust.	Fasten if loosened. Remove rust if present.
Display unit	Dust on the cabinet, LCD	Remove dust from the cabinet with a dry clean cloth. Wipe the LCD carefully to prevent scratching, using tissue paper and an LCD cleaner. To remove dirt or salt deposits, use an LCD cleaner, wiping slowly with tissue paper so as to dissolve the dirt or salt. Change paper frequently so the salt or dirt will not scratch the LCD. Do not use commercial cleaners to clean the equipment. Those cleaners can remove paint and markings.
Transducer	Face of transducer	Marine life and growth on the transducer can lower sensitivity. Remove any foreign material from the face of the transducer with a wooden stick or fine sandpaper.

12.2 How to Replace the Fuse

The fuse (3A) in the fuse holder on the power cable protects the display unit from high electric current and equipment fault. If you cannot turn on the power, check the fuse to see if it has blown. If the fuse has blown, find the reason before you replace the fuse. If the fuse blows again after the replacement, contact your dealer for advice.

 WARNING
<p>Use the proper fuse.</p> <p>Use of a wrong fuse can result in fire and damage the equipment.</p>

12.3 Troubleshooting

This section provides simple troubleshooting procedures which the user can follow to restore normal operation. If you cannot restore normal operation, do not check inside the unit. Have a qualified technician check the equipment.

Problem	Remedy
General Troubleshooting	
You cannot turn on the power.	<ul style="list-style-type: none"> • Check for blown fuse. • Check that the power connector is tightly fastened. • Check for corrosion on the power cable connector. • Check for damaged power cable. • Check the battery voltage is 10.8 to 31.2 V.
No picture appears even though the power is on.	Press the POWER/BRILL key and rotate the RotoKey™ clockwise to raise the brilliance.
There is no response when a key is pressed.	Turn off and on the power. If you do not get a response, the key is damaged. Contact your dealer for instructions.
Plotter Troubleshooting	
Position is not fixed within 90 seconds.	<ul style="list-style-type: none"> • Check that the antenna connector is tightly fastened. • Check the number of satellites received, on the GPS Status Display. • Check if [POSITION&SOG/COG] in the [SELECT INPUT DEVICE] menu in the [INTERFACE] menu is set to [Internal GPS]. Execute [RESTART GPS] in the [INTERNAL GPS SETUP] menu in the [SYSTEM] menu.
Bearing is wrong.	Check the magnetic variation setting at [COMPASS SETUP] in the [SYSTEM] menu.
The track of your boat is not plotted.	Check that the track is turned on. Operate the [Track] soft control to turn track on.

Problem	Remedy
The speed indication is not zero after the ship is stopped.	Set [NAVIGATION SPEED] to [Low] in the [INTERNAL GPS SETUP] in the [SYSTEM] menu.
Fish Finder Troubleshooting	
You selected a fish finder display, but no picture appears.	<ul style="list-style-type: none"> • Check that the transducer cable is fastened. • Check if the fish finder source is correctly selected.
Marks and characters appear, but no picture appears.	Check that the transducer cable is connected.
Picture appears but zero line does not appear.	<ul style="list-style-type: none"> • The picture is shifted. Check the shift setting. • Check if [ZERO LINE REJECTION] in the [FISH FINDER] menu is off.
The picture sensitivity is too low.	<ul style="list-style-type: none"> • Check the gain setting in manual operation. • Check if marine life or air bubbles are on the transducer. • Bottom is too soft to return an acceptable echo.
The depth indication does not appear.	<ul style="list-style-type: none"> • For manual operation, adjust gain and range to display the bottom echo (in reddish-brown). • Adjust the bottom level. • Check if [DEPTH] in the [SELECT INPUT DEVICE] menu in the [INTERFACE] menu is set to [Fish Finder].
Noise or interference shows on the display.	<ul style="list-style-type: none"> • Make sure the transducer cable is not near the engine. • Check the ground connection. • Check if another fish finder in the vicinity of your boat has the same operating frequency as your fish finder. • Try to adjust the interference rejector.

12.4 GPS Status Display

The GPS status display shows the RX signal strength and the location of each GPS satellite received. By default, the GPS status display is provided on a home screen.

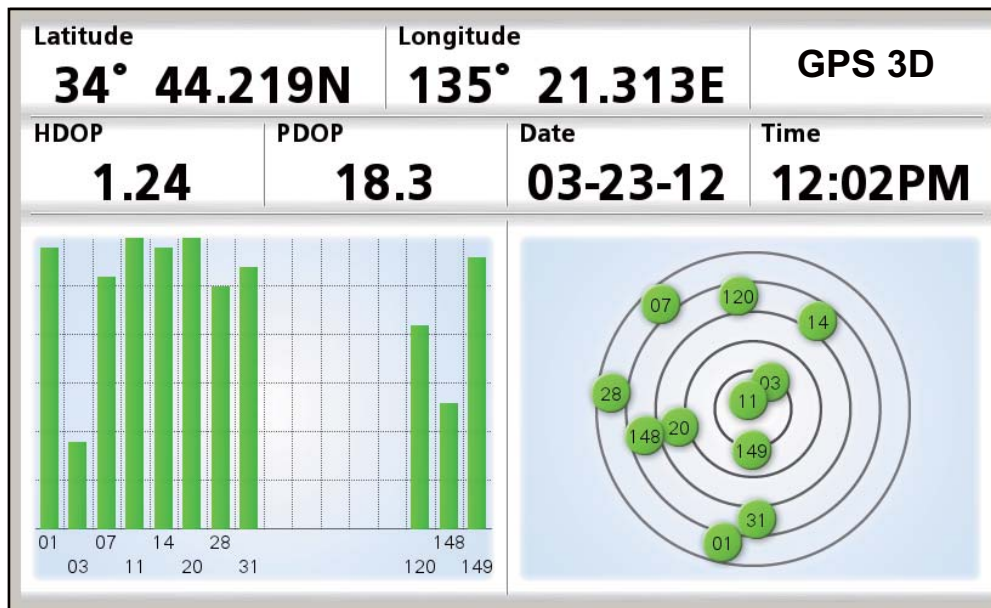

Description of GPS status display

- The graphic at the right side of the display shows the position of each GPS satellite in the sky. The circles are colored according to a satellite's SNR. Green if the SNR of the satellite is high enough to be used to fix position, or red if the SNR is too low to be used to fix position.
- The bars in the graph at the left show the strength of the RX signal from each satellite. Satellites that have a signal level of 40 or higher are used to fix position. The bars are colored in the same manner as the circles.
- HDOP (Horizontal Dilution of Precision) is an indication of the precision of the position fix from the GPS based on the satellites. The lower the number the more accurate the position fix. An HDOP of 2.0 or less is considered good, and 20.0 or above will result in a loss of fix.
- PDOP (Position Dilution of Precision) is the accuracy of a 3D GPS position based on the number of satellites and the geometry of satellite positions. PDOP ranges from 0-99. The lower the number, the more accurate the data.

12.5 How to Restore Defaults, Clear Memory

You may wish to restore default or user settings.

1. Open the [SYSTEM] menu then select [DEFAULT SETTINGS].

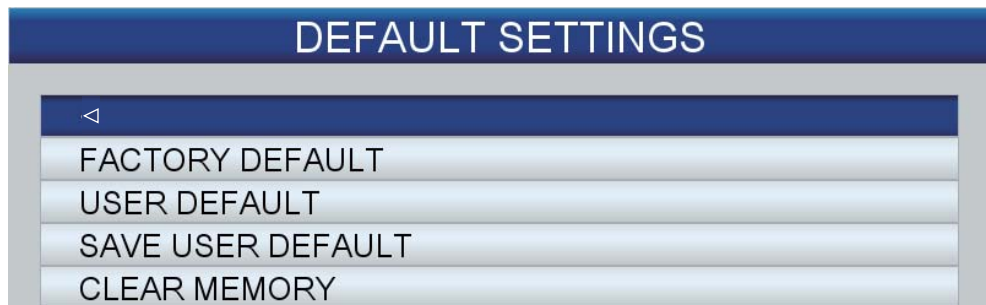

2. Select one of the following according to your objective.
 - [FACTORY DEFAULT]: Restore all default factory settings. User-saved items (waypoint, routes, etc.) are not erased.
 - [USER DEFAULT]: Restore the user settings saved with [SAVE USER DEFAULT]. User-saved items and user settings are not erased.
 - [SAVE USER DEFAULT]: Save all current user settings as default user settings. Waypoints, routes, etc. stored in the memory are not erased.
 - [CLEAR MEMORY]: All default factory and default user settings are erased. User-saved items (waypoints, routes, etc.) are erased.
3. A message asks if you are sure to complete the action selected. The [YES] button is selected; press the **ENT** key to complete the action. Then, one of the following occurs:
 - [FACTORY DEFAULT]: The power is reset.
 - [USER DEFAULT]: The power is reset.
 - [SAVE USER DEFAULT]: User defaults are saved.
 - [CLEAR MEMORY]: The power is reset.

12.6 System Information

The system information display, for use by the service technician, shows chart operating system information, license information and the data access manager report. Open the [SYSTEM] menu and select [SYSTEM INFORMATION] to show the charting operating system display. Select [License] or [DAM Report] to show the respective display. The information shown in the figure below may be different from what you see on your display.

CHARTING OPERATING SYSTEM
 Copyright © 2012 JEPPESEN Italia S.r.l.

Unit ID	F8F8F1CA
Plotter Software version	V0.0.1.27 [16-03-2012]
SDK version	V8.2.35R (28/02/2012)
BIOS version	V1.5.19R [18/01/2011]
OS version	Simulator
GPS version	Generic
C-Weather version	V1.20.00 R [18/08/2009].
FF Lib Module	V4.00.13B [08/03/2012]
Built-In Chart	WW-D300.27
	WORLD
SD Card Chart	0
User Points	30000
Routes	1000
Track Points	30000

License
DAM Report

License

DATA ACCESS MANAGER REPORT

WW-D300.27	WORLD
Date of Release	01/12/2011
Chart Updated	01/12/2011
Property Status	Purchased Chart
Chart Media	Internal File
Warning Status	No Warnings
Segmentation	4D

controls: UP/DOWN for scroll, ESC for exit

DAM report

13. INSTALLATION

13.1 Installation of Display Unit

Mounting considerations

The display unit can be installed on a tabletop or flush mounted in a console.

Select a suitable mounting location considering the following:

- Keep the display unit out of direct sunlight.
- The temperature and humidity should be moderate and stable.
- Locate the unit away from exhaust pipes and vents.
- The mounting location should be well ventilated.
- Mount the unit where shock and vibration are minimal.
- Keep the unit away electromagnetic field generating equipment such as motor, generator.
- For maintenance and checking purposes, leave sufficient space at the sides and rear of the unit and leave slack in cables.
- A magnetic compass will be affected if placed too close to the display unit. Observe the compass safe distances shown in the Safety Information to prevent disturbance to a magnetic compass.

Mounting procedure

Follow the procedure below to mount the display unit on a tabletop or in a console. Refer to the outline drawings at the back of this manual.

Tabletop mounting

1. Fix the hanger by four self-tapping screws ($\phi 4.8 \times 22$, supplied).
2. Screw knob bolts in display unit, set it to hanger, and tighten knob bolts.
3. Attach hard cover to protect LCD.

Flush mounting

Follow the procedure below to mount the display unit in a console. Refer to the outline drawing at the back of this manual.

1. The thickness of the cutout should be 5 to 18 mm.
2. Prepare a cutout in the mounting location whose dimensions are shown in the outline drawings at the back of this manual.
3. Screw in four threaded rods (supplied) into the display unit.
4. Set the display unit to the cutout and fasten it with the washers and nuts.

13.2 Installation of Antenna Unit

Mounting considerations

The antenna unit GPA-017/017S (option) is available for receiving GPS signal with farther sensitivity.

Select a suitable mounting location considering the following:

- Select a location out of the radar beam. The radar beam will obstruct or prevent reception of the GPS satellite signal.
- The location should be well away from a VHF antenna. A GPS receiver is interfered by a harmonic wave of a VHF antenna.
- There should be no interfering object within the line-of-sight to the satellites. Objects within line-of-sight to a satellite, for example, a mast, may block reception or prolong acquisition time.
- Mount the antenna unit as high as possible. Mounting the antenna unit as high as possible keeps it free of interfering objects and water spray, which can interrupt reception of GPS satellite signal if the water freezes.
- If the antenna cable is to be passed through a hole which is not large enough to pass the connector, you may unfasten the connector with a needle nose pliers and 3/8-inch open-end wrench. Refasten it as shown below after running the cable through the hole.

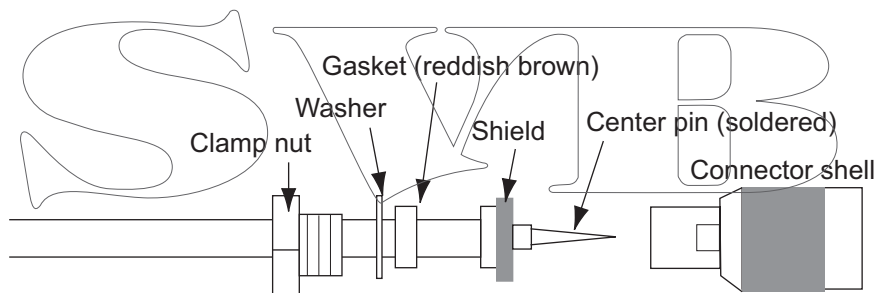

- If the internal GPS antenna is used, be sure there are no obstructions above or around the display unit.

13.3 Installation of Transducers

13.3.1 How to mount a transducer through the hull

Transducer mounting location

The thru-hull mount transducer provides the best performance of all, since the transducer protrudes from the hull and the effect of air bubbles and turbulence near the hull skin is reduced. If your boat has a keel, the transducer should be at least 30 cm away from it.

The performance of this fish finder is directly related to the mounting location of the transducer, especially for high-speed cruising. The installation should be planned in advance, keeping the length of the transducer cable and the following factors in mind:

- Air bubbles and turbulence caused by movement of the boat seriously degrade the sounding capability of the transducer. The transducer should, therefore, be located

in a position where water flow is the smoothest. Noise from the propellers also adversely affects performance and the transducer should not be mounted nearby. The lifting strakes are notorious for creating acoustic noise, and these must be avoided by keeping the transducer inboard of them.

- The transducer must always remain submerged, even when the boat is rolling, pitching or up on a plane at high speed.
- A practical choice would be somewhere between 1/3 and 1/2 of your boat's length from the stern. For planing hulls, a practical location is generally rather far astern, so that the transducer is always in water regardless of the planing attitude.

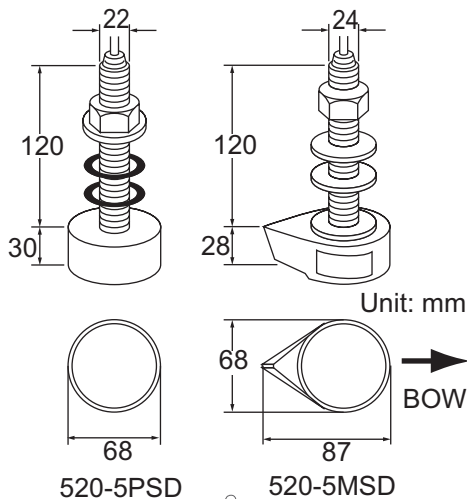

Transducer mounting locations

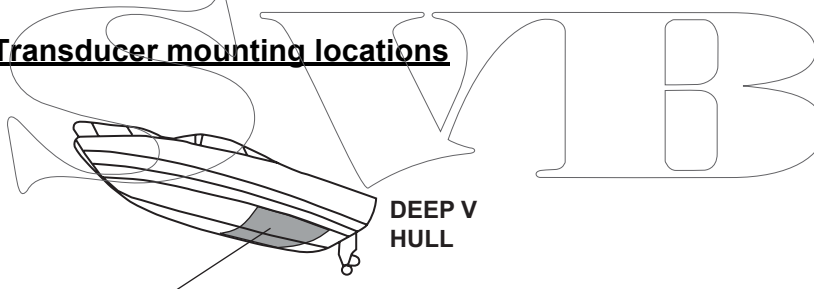

- Position 1/2 to 1/3 of the hull from stern.
- 15 to 30 cm off center line (inside first lifting strakes.)

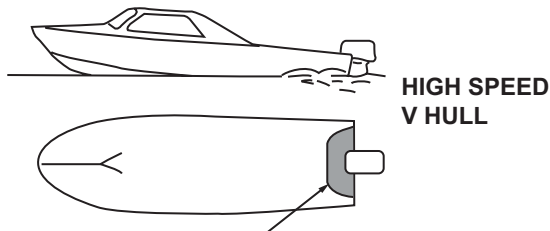

- Within the wetted bottom area
- Deadrise angle within 15°

Installation procedure

1. With the boat hauled out of the water, mark the location chosen for mounting the transducer on the bottom of the hull.
2. If the hull is not level within 15° in any direction, fairing blocks made out of teak should be used between the transducer and hull, both inside and outside, to keep the transducer face parallel with the water line. Fabricate the fairing block as shown below and make the entire surface as smooth as possible to provide an un-

13. INSTALLATION

disturbed flow of water around the transducer. The fairing block should be smaller than the transducer itself to provide a channel to divert turbulent water around the sides of the transducer rather than over its face.

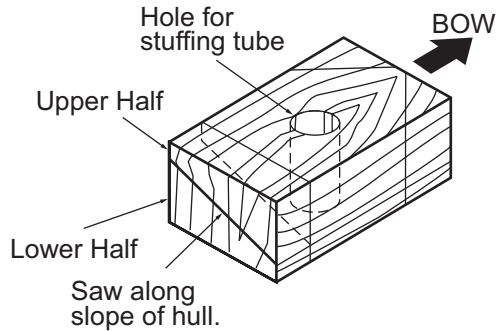

3. Drill a hole just large enough to pass the threaded stuffing tube of the transducer through the hull, making sure it is drilled vertically.
4. Apply a sufficient amount of high quality caulking compound to the top surface of the transducer, around the threads of the stuffing tube and inside the mounting hole (and fairing blocks if used) to ensure watertight mounting.
5. Mount the transducer and fairing blocks and tighten the locknut. Be sure that the transducer is properly oriented and its working face is parallel to the waterline.

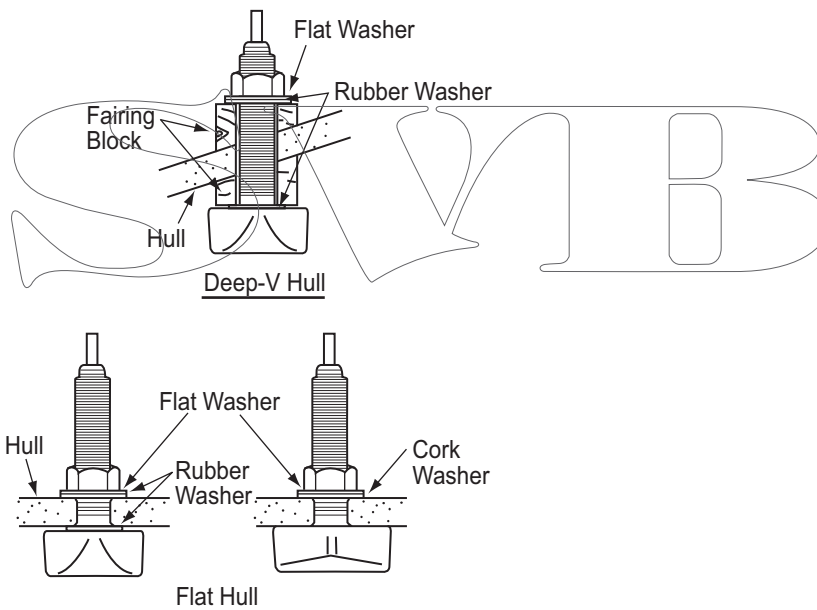

Note: Do not over-stress the stuffing tube and locknut through excessive tightening, since the wood block will swell when the boat is placed in the water. It is suggested that the nut be tightened lightly at installation and retightened several days after the boat has been launched.

Transducer preparation

Before putting your boat in water, wipe the face of the transducer thoroughly with a detergent liquid soap. This will lessen the time necessary for the transducer to have good contact with the water. Otherwise the time required for complete "saturation" will be lengthened and performance will be reduced.

DO NOT paint the transducer. Performance will be affected.

13.3.2 Transom mount transducer

The optional transom mount transducer is very commonly employed, usually on relatively small I/O or outboard boats. Do not use this method on an inboard motor boat because turbulence is created by the propeller ahead of the transducer.

DO NOT overtighten screws, to prevent damage to the transducer.

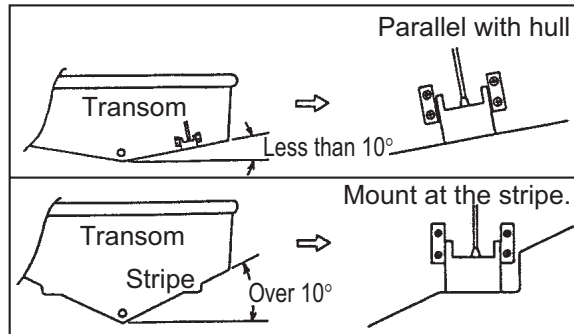

Installation procedure

A suitable mounting location is at least 50 cm away from the engine and where the water flow is smooth.

1. Drill four pilot holes for self-tapping screw (5x20) in the mounting location.
2. Coat the threads of the self-tapping screws (5x14) for the transducer with silicone sealant for waterproofing. Attach the transducer to the mounting location with the self-tapping screws.
3. Adjust the transducer position so the transducer faces right to the bottom. If necessary, to improve water flow and minimize air bubbles staying on the transducer face, incline the transducer about 5° at the rear. This may require a certain amount of experimentation for fine tuning at high cruising speeds.
4. Tape the location shown in the figure below.

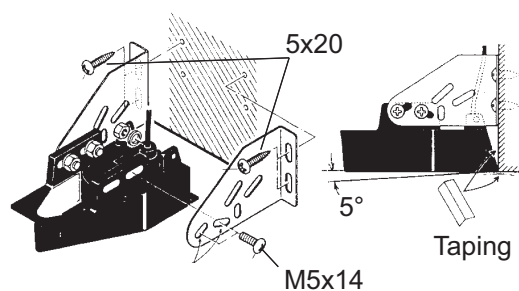

5. Fill the gap between the wedge front of the transducer and transom with epoxy material to eliminate any air spaces.
6. After the epoxy hardens, remove the tape.

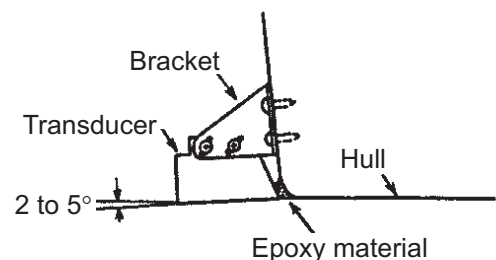

13.3.3 How to mount a transducer inside the hull

The transducer may also be installed inside the hull on FRP boats. However, this installation method affects the ability to detect the bottom, fish and other objects because the ultrasound pulse is weakened when it passes through the hull.

Note: This mounting method should not be used to mount the transducer that supports the ACCU-FISH™ and/or bottom discrimination display feature, since performance is greatly degraded.

Necessary tools

The following tools are required:

- Sandpaper (#100)
- Silicone sealant

Remarks on installation

- Do the installation with the ship moored at a dock, etc. The water depth should be 6.5-32 feet (2-10 meters).
- Turn off the engine.
- Do not power the unit with the transducer in the air, to prevent damage to the transducer.
- Do not use this method on a double layer hull.
- Before attaching the transducer to the hull, check that the site is suitable. Put the transducer in a water-filled plastic bag. Connect the transducer to the display unit and put the transducer on the installation site. Turn on the display unit and check that the depth indication appears.

Installation procedure

The attenuation of the ultrasound pulse varies with the thickness of the hull. Select a location where attenuation is the lowest.

1. Select 2-3 locations considering the four points mentioned below. (You will finalize the mounting location through some trial and error later.)

- Mount the transducer at a location 1/2 to 1/3 of the length of your boat from the stern.
- The mounting location is between 15 to 50 cm from the centerline of the hull.
- Do not place the transducer over hull struts or ribs which run under the hull.
- Avoid a location where the rising angle of the hull exceeds 15°, to minimize the effect of the boat's rolling.

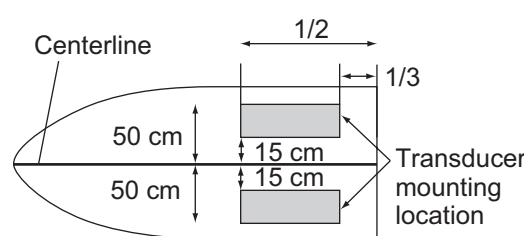

The diagram shows a cross-section of a boat hull. A horizontal line represents the centerline. Two vertical double-headed arrows, each labeled '50 cm', indicate the thickness of the hull above and below the centerline. Two rectangular boxes represent the transducer mounting locations, one above and one below the centerline. Each box is 15 cm wide, as indicated by vertical double-headed arrows. A horizontal double-headed arrow above the boxes is labeled '1/2', and another horizontal double-headed arrow to the right of the boxes is labeled '1/3', indicating their position relative to the stern.

2. Clean the face of the transducer to remove any foreign material. Lightly roughen the face with #100 sandpaper. Also, use the sandpaper to roughen the inside of the hull where the transducer is to be mounted.

3. Wipe off any sandpaper dust from the face of the transducer.
4. Dry the face of the transducer and the hull. Coat the transducer face and mounting location with silicone sealant. Hardening begins in approx. 15-20 minutes so do this step without delay.

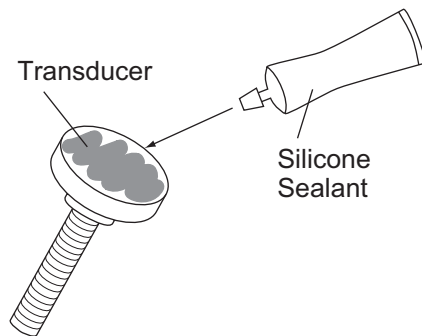

5. Attach the transducer to the hull. Press the transducer firmly down on the hull and gently twist it back and forth to remove any air which may be trapped in the silicone sealant.
6. Support the transducer with a piece of wood to keep it in place while the sealant is drying. It takes 24-72 hours to harden completely.

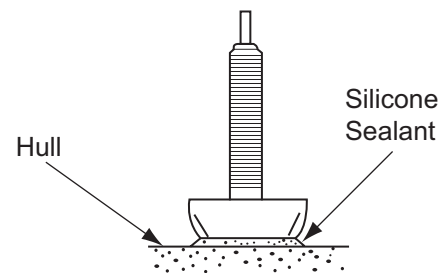

13.3.4 Triducer

DO NOT overtighten screws, to prevent damage to the transducer.

525STID-MSD

The optional triducer 525STID-MSD is designed for thru-hull mounting.

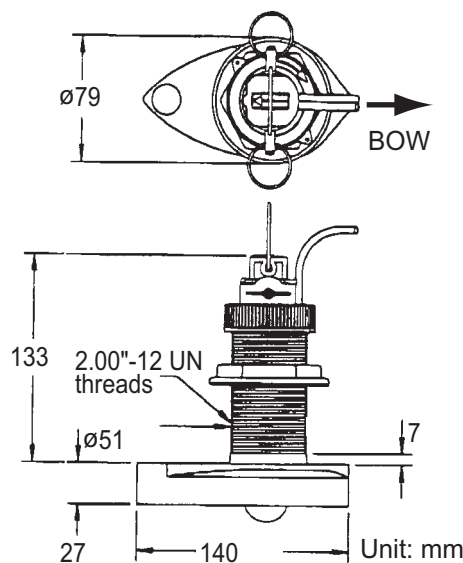

525STID-PWD

The optional transom mount triducer 525STID-PWD can be installed by the thru-hull method or the inside-hull method.

13. INSTALLATION

Pre-test for speed and temperature

Connect the sensor to the instrument and spin the paddlewheel. Check for a speed reading and the approximate air temperature. If there is no reading, return the sensor to your place of purchase.

Tools and materials required

- Scissors
- Safety goggles
- Electric drill
- Drill bit:
 - For bracket holes: 4 mm, #23, or 9/64"
 - For fiberglass hull: chamfer bit (preferred), 6 mm, or 1/4"
 - For transom hole: 9 mm or 3/4" (optional)
 - For cable clamp holes: 3 mm or 1/8"
- Straight edge
- Pencil
- Water-based anti-fouling paint (mandatory in salt water)
- Masking tape
- Dust mask
- Screwdrivers
- Silicone sealant
- Cable ties

Mounting location

To ensure the best performance, the sensor must be submerged in aeration-free and turbulence-free water. Mount the sensor close to the centerline of your boat. On slower heavier displacement hulls, positioning it farther from the centerline is acceptable.

Allow adequate space above the bracket for it to release and rotate the sensor upward.

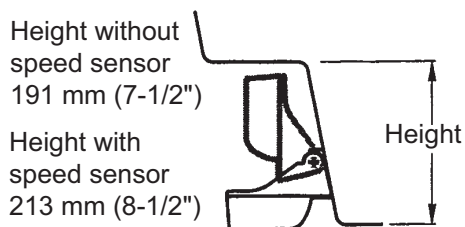

Note 1: Do not mount the sensor in an area of turbulence or bubbles: near water intake or discharge openings; behind strakes, struts, fittings, or hull irregularities; behind eroding paint (an indication of turbulence).

Note 2: Avoid mounting the sensor where the boat may be supported during trailering, launching, hauling, and storage.

Note 3: For single drive boat, mount on the starboard side at least 75 mm (3") beyond the swing radius of the propeller, as shown in the right figure.

Note 4: For twin drive boat, mount between the drives.

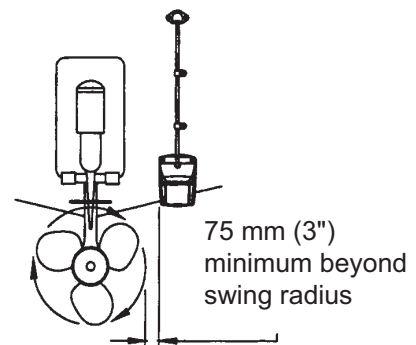

How to install the bracket

1. Cut out the installation template (enclosed with transducer) along the dotted line.
2. At the selected location, position the template, so the arrow at the bottom is aligned with the bottom edge of the transom. Being sure the template is parallel to the waterline, tape it in place.

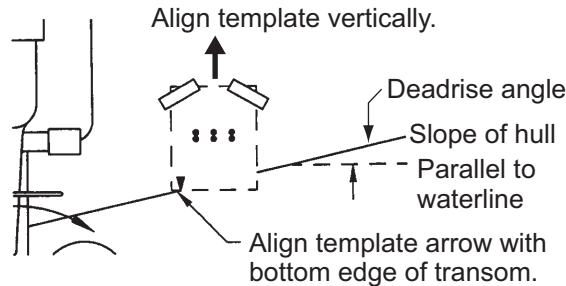

Warning: Always wear safety goggles and a dust mask.

3. Using a 4 mm, #23, or 9/64" bit, drill three holes 22 mm (7/8") deep at the locations indicated. To prevent drilling too deeply, wrap masking tape around the bit 22 mm (7/8") from the point.

Fiberglass hull: Minimize surface cracking by chamfering the gelcoat. If a chamfer bit or countersink bit is not available, start drilling with a 6mm or 1/4" bit to a depth of 1 mm (1/16").

4. If you know your transom angle, the bracket is designed for a standard 13° transom angle.

11°-18° angle: No shim is required. Skip to step 3 in "Adjustments".

Other angles: The shim is required. Skip to step 2 of "Adjustments".

If you do not know the transom angle, temporarily attach the bracket and sensor to the transom to determine if the plastic shim is needed.

5. Using the three #10 x 1-1/4" self-tapping screws, temporarily screw the bracket to the hull. DO NOT tighten the screws completely at this time. Follow the step 1-4 in "How to attach the sensor to the bracket", before proceeding with "Adjustments".

Adjustments

1. Using a straight edge, sight the underside of the sensor relative to the underside of the hull. The stern of the sensor should be 1-3 mm (1/16-1/8") below the bow of the sensor or parallel to the bottom of the hull.

Note: Do not position the bow of the sensor lower than the stern because aeration will occur.

2. To adjust the sensor's angle relative to the hull, use the tapered plastic shim provided. If the bracket has been temporarily fastened to the transom, remove it. Key the shim in place on the back of the bracket.

2°-10° transom angle (stepped transom and jet boats): Position the shim with the tapered end down.

13. INSTALLATION

19°-22° transom angle (small aluminum and fiberglass boats): Position the shim with the tapered end up.

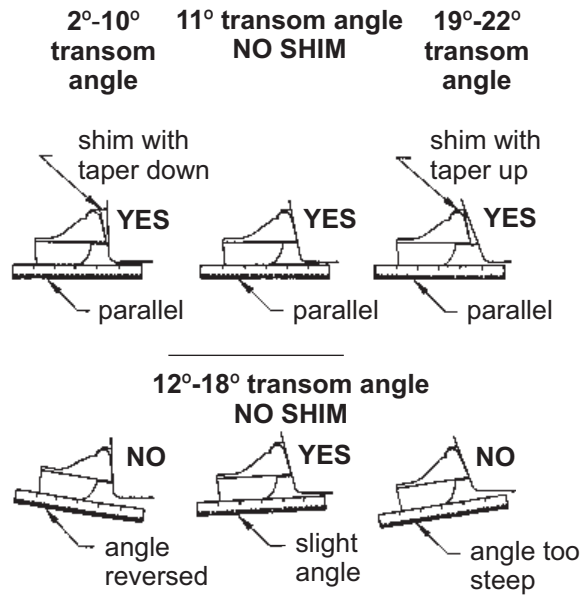

3. If the bracket has been temporarily fastened to the transom, remove it. Apply a marine sealant to the threads of the three #10 x 1-1/4" self-tapping screws to prevent water seeping into the transom. Screw the bracket to the hull. Do not tighten the screws completely at this time.
4. Repeat step 1 to ensure that the angle of the sensor is correct.
Note: Do not position the sensor farther into the water than necessary to avoid increasing drag, spray, and water noise and reducing boat speed.
5. Using the vertical adjustment space on the bracket slots, slide the sensor up or down to provide a projection of 3 mm (1/8"). Tighten the screws.

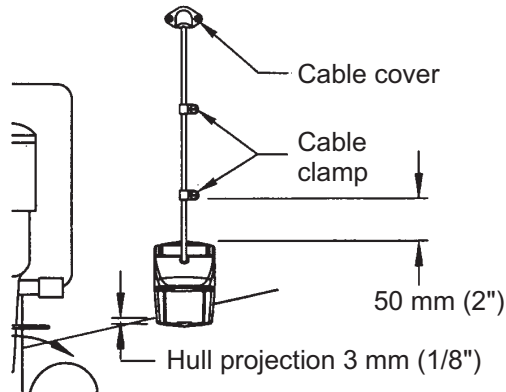

How to attach the sensor to the bracket

1. If the retaining cover near the top of the bracket is closed, open it by depressing the latch and rotating the cover downward.

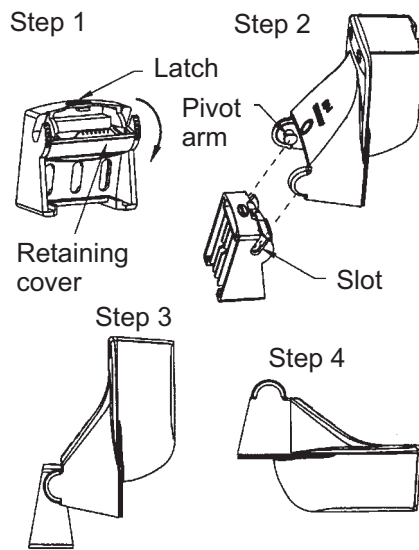

2. Insert the sensor's pivot arms into the slots near the top of the bracket.
3. Maintain pressure until the pivot arms click into place.
4. Rotate the sensor downward until the bottom snaps into the bracket.
5. Close the retaining cover to prevent the accidental release of the sensor when your boat is underway.

How to route the cable

Route the sensor cable over the transom, through a drain hole, or through a new hole drilled in the transom above the waterline.

Never cut the cable or remote the connector; this will void the warranty. Always wear safety goggles and a dust mask.

1. If a hole must be drilled, choose a location well above the waterline. Check for obstructions such as trim tabs, pumps, or wiring inside the hull. Mark the location with a pencil. Drill a hole through the transom using a 19 mm or 3/4" bit (to accommodate the connector).
2. Route the cable over or through the transom.
3. On the outside of the hull secure the cable against the transom using the cable clamps. Position a cable clamp 50 mm (2") above the bracket and mark the mounting hole with a pencil.
4. Position the second cable clamp halfway between the first clamp and the cable hole. Mark this mounting hole.
5. If a hole has been drilled in the transom, open the appropriate slot in the transom cable cover. Position the cover over the cable where it enters the hull. Mark the two mounting holes.
6. At each of the marked locations, use a 3 mm or 1/8" bit to drill a hole 10 mm (3/8") deep. The prevent drilling too deeply, wrap masking tape around the bit 10 mm (3/8") from the point.

13. INSTALLATION

7. Apply marine sealant to the threads of the #6 x 1/2" self-tapping screw to prevent water from seeping into the transom. If you have drilled a hole through the transom, apply marine sealant to the space around the cable where it passes through the transom.
8. Position the two cable clamps and fasten them in place. If used, push the cable cover over the cable and screw it in place.
9. Route the cable to the display unit being careful not to tear the cable jacket when passing it through the bulkhead(s) and other parts of the boat. To reduce electrical interference, separate the sensor cable from other electrical wiring and "noise" sources. Coil any excess cable and secure it in place with zip-ties to prevent damage.

13.4 Installation of Sensors (option)

13.4.1 Speed/temperature sensors ST-02MSB, ST-02PSB

The speed/temperature sensors (ST-02MSB, ST-02PSB) are designed for thru-hull mounting. Install them as shown in this section.

Mounting considerations

Select a suitable mounting location, considering the following:

- Select a location where the transducer will not be damaged in trailering, launching, hauling, and storage.
- Select a mid-boat flat position. The sensor does not have to be installed perfectly perpendicular.
- Select a location in the forward direction viewing from the drain hole, to allow for circulation of cooling water.
- Select a location away from water flow from keel, water discharge pipe, etc.
- Vibration at the location shall be minimal.
- Do not install fore of the transducer of a fish finder, to prevent disturbance (and loss of performance) to the fish finder.

Mounting procedure

1. Dry-dock the boat.
2. Make a hole of approx. 51 mm diameter in the mounting location.
3. Unfasten the locknut and remove the sensor section.
4. Apply silicone sealant to the flange of the sensor. The height of the coat should be approx. 6 mm.
5. Pass the sensor casing through the hole.
6. Face the notch on the sensor toward boat's bow and tighten the flange.
7. Set the sensor section to the sensor casing and tighten the locknut.

8. Launch your boat and check for water leakage around the sensor.

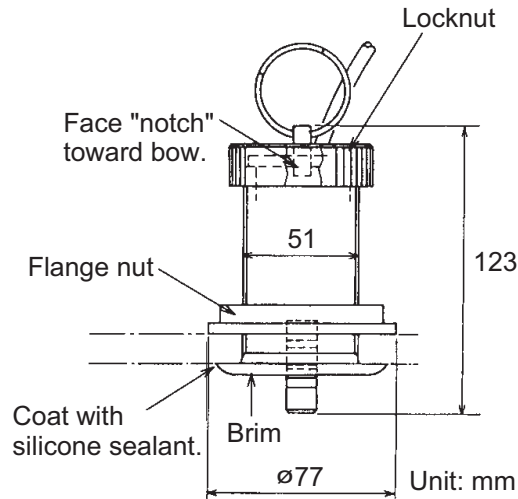

13.4.2 Temperature sensors

Transom mount temperature sensor T-02MTB

- Fix the cable at a convenient location on the transom with the cable clamp.
- When the cable is led through the transom board, make a hole of approx. 17 mm in diameter to pass the connector. After passing the cable, seal the hole with a sealing compound.

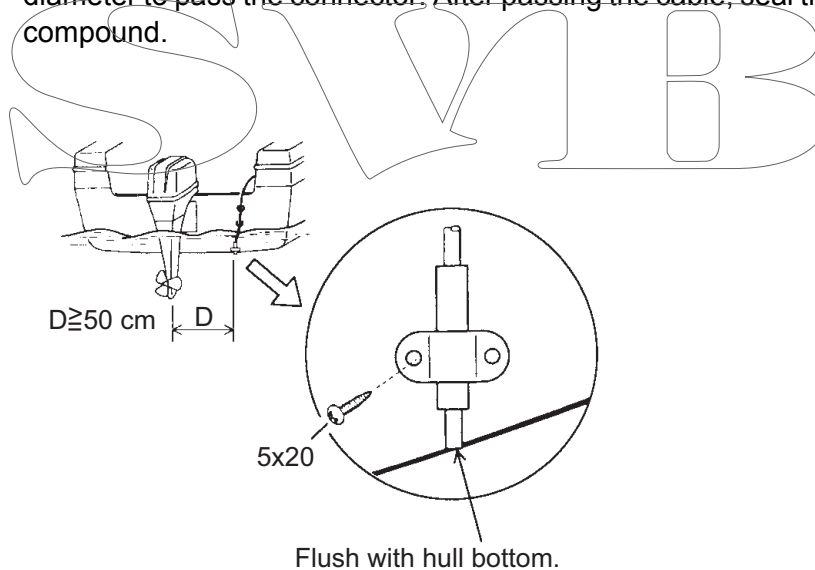

Thru-hull mount temperature sensor T-02MSB, T-03MSB

Select a suitable mounting location considering the following points:

- Select a mid boat flat position.
- Select a location where the transducer will not be damaged in trailering, launching, hauling, and storage.
- Locate away from equipment which gives off heat.
- Locate away from drain pipes.
- Select a location where vibration is minimal.

Install the sensor as shown on the next page.

13. INSTALLATION

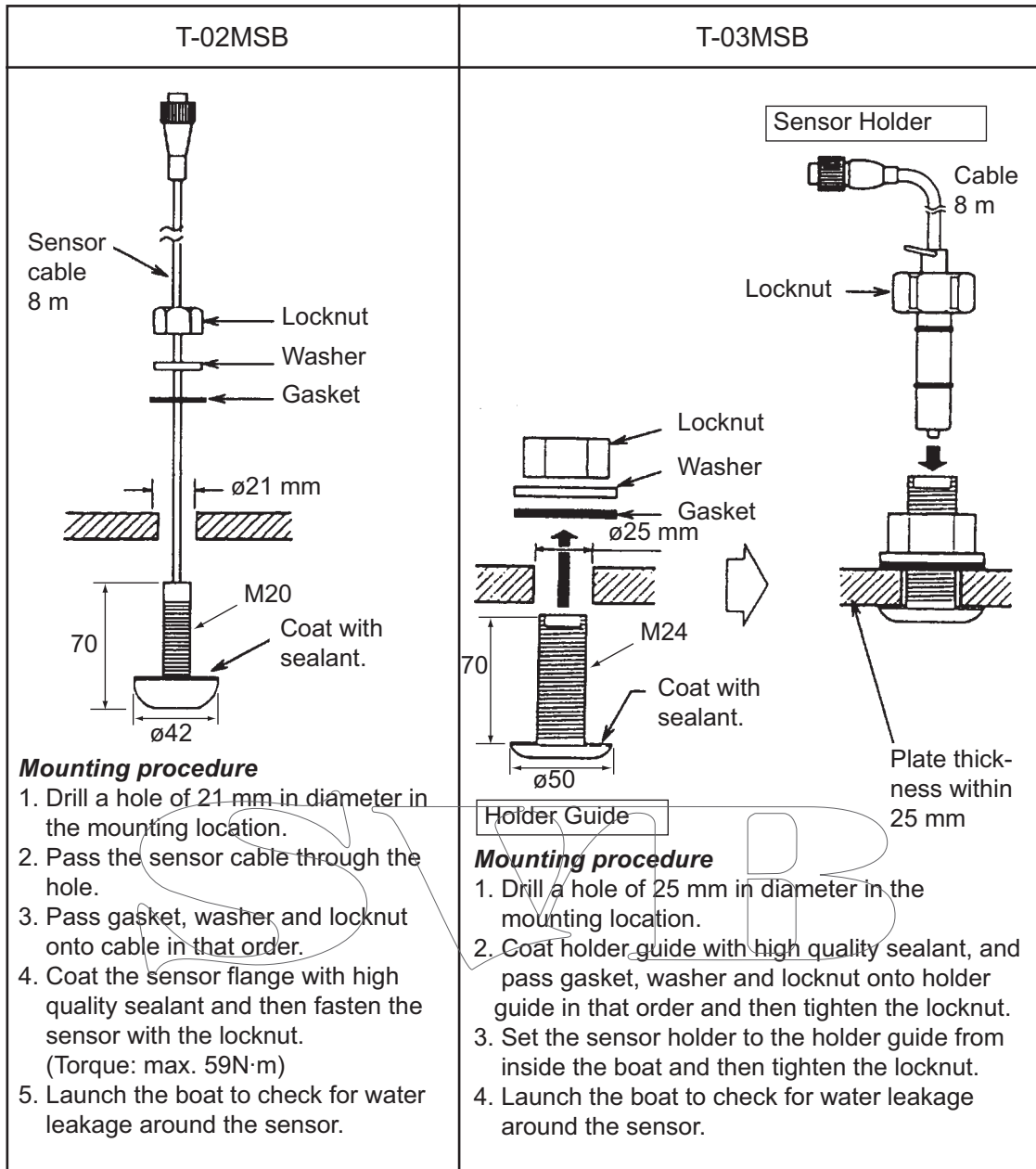

13.5 Wiring

All wiring are terminated at the rear of the display unit. Refer to the interconnection diagram on page S-1.

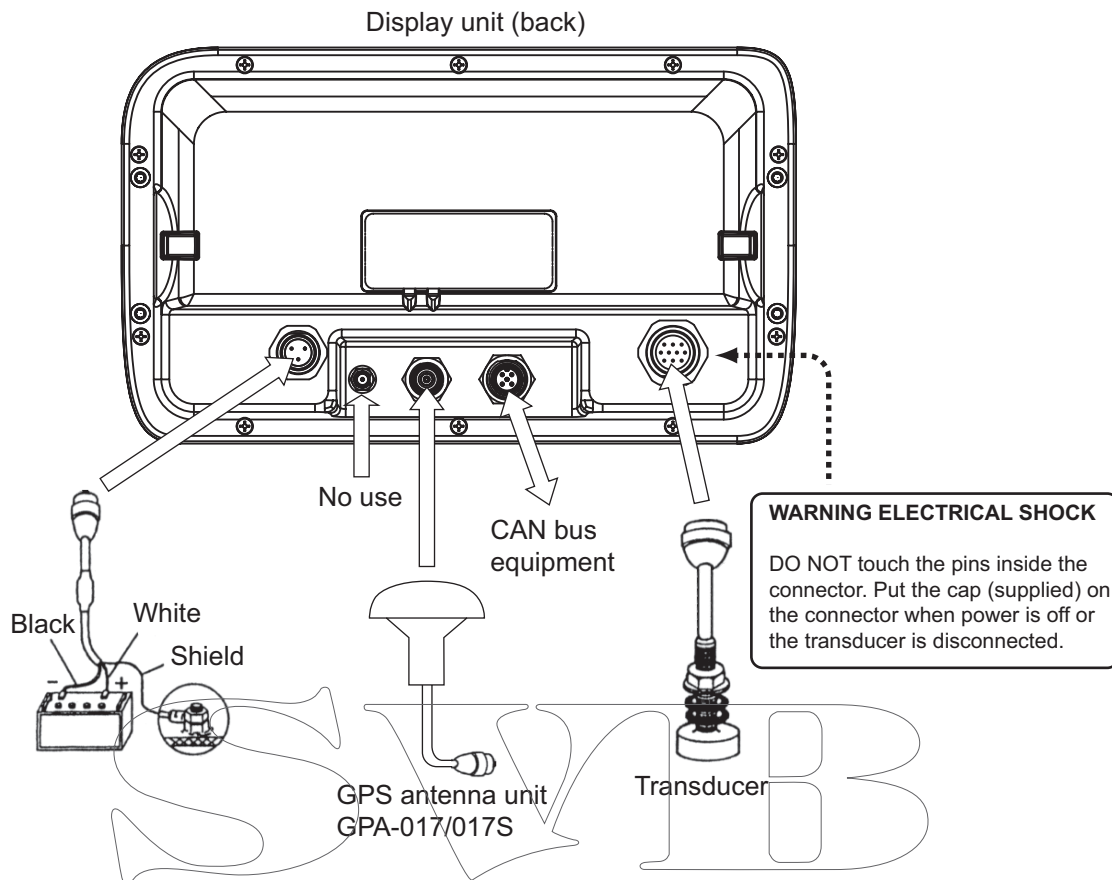

Power cable

Connect the power cable to the power connector. Connect the leads to the battery (12 or 24 VDC); white to plus(+) terminal and black to minus(-) terminal. Ground the shield to ship's ground.

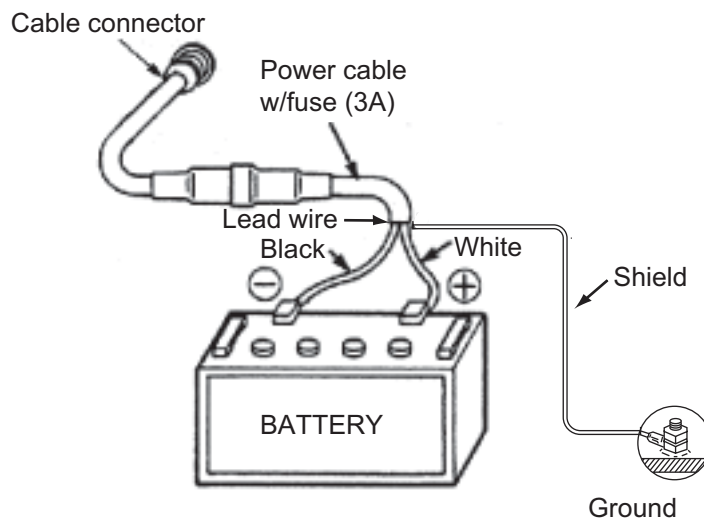

Note: The fuse is not waterproof. Wrap the fuse holder with vinyl tape to keep water out of the fuse holder.

13. INSTALLATION

GPS antenna unit (option)

Connect the antenna cable to the GPS connector.

How to attach the M-P-8DFB connector

Outer sheath Dimensions in millimeters.

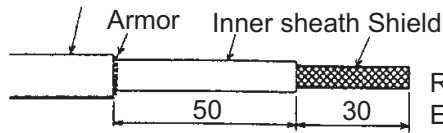

Remove outer sheath and armor by the dimensions shown left. Expose inner sheath and shield by the dimensions shown left.

Cover with heat-shrink tubing and heat.

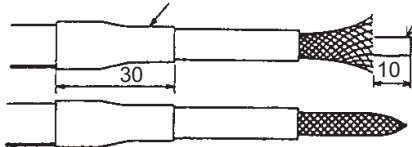

Cut off insulator and conductor by 10mm.

Twist shield end.

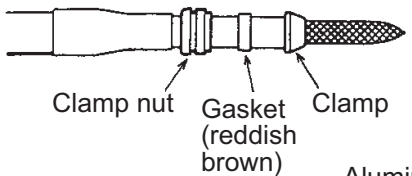

Slip on clamp nut, gasket and clamp as shown left.

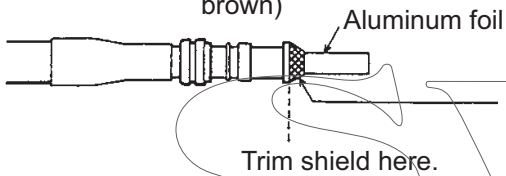

Fold back shield over clamp and trim.

Trim shield here.

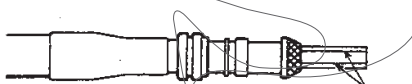

Cut aluminum foil at four places, 90° from one another.

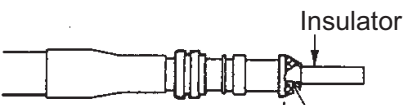

Fold back aluminum foil onto shield and trim.

Trim aluminum tape foil here.

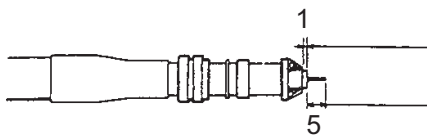

Expose the insulator by 1 mm.

Expose the core by 5 mm.

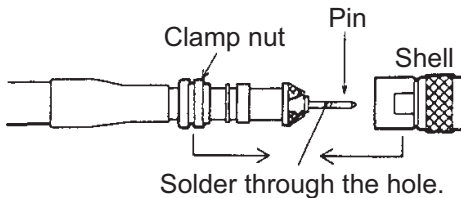

Slip the pin onto the conductor. Solder them together through the hole on the pin.

Insert the pin into the shell. Screw the clamp nut into the shell. (Tighten by turning the clamp nut. Do not tighten by turning the shell.)

How to waterproof the connector

Wrap the connector with vulcanizing tape and then vinyl tape. Bind the tape ends with cable-ties.



How to extend cable length (GPA-017S)

The standard cable is 10 m long. For extension, in case of the GPA-017S, an antenna cable set of 30 m or 50 m is available. Extension cable cannot be used with the GPA-017.

Fabricate the end of the antenna cable and attach the coaxial connector. See the preceding page.

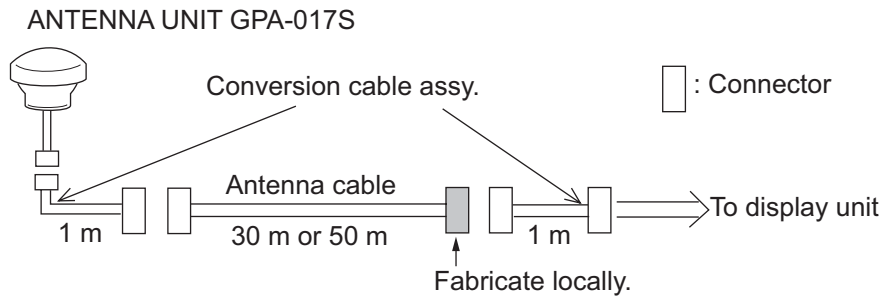

Transducer

Connect the transducer cable to the XDR port.

Transducer and sensor

Use the optional conversion cable (02S4147) to connect the optional speed/temperature sensor and the transducer to the XDR port.

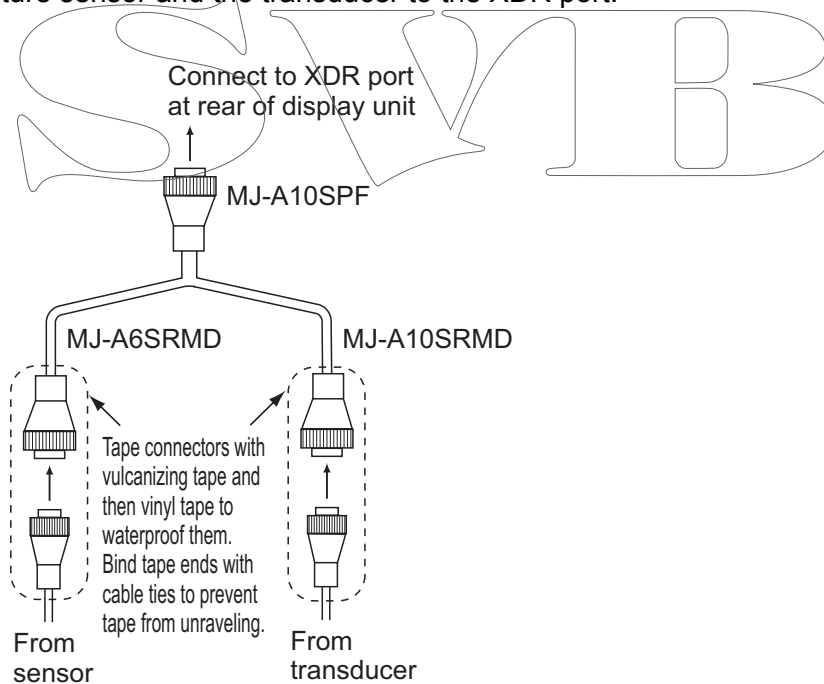

Matching box (option, required for 1kW transducer)

The optional matching box (Type: MB-1100, Code No.: 000-041-353) is required to connect the optional transducers 50B-6, 50B-6B, 200B-5S, 50/200-1T and 50/200-12M.

Part	Type	Code no.	Qty
Matching Box*	MB-1100	000-041-353	1
Crimp-on Lug	FV1.25-3 (LF)	000-116-756-10	6
Cord Lock**	NC-1	000-168-230-10	1

*: With 10P connector cable
 **: For connecting two transducers

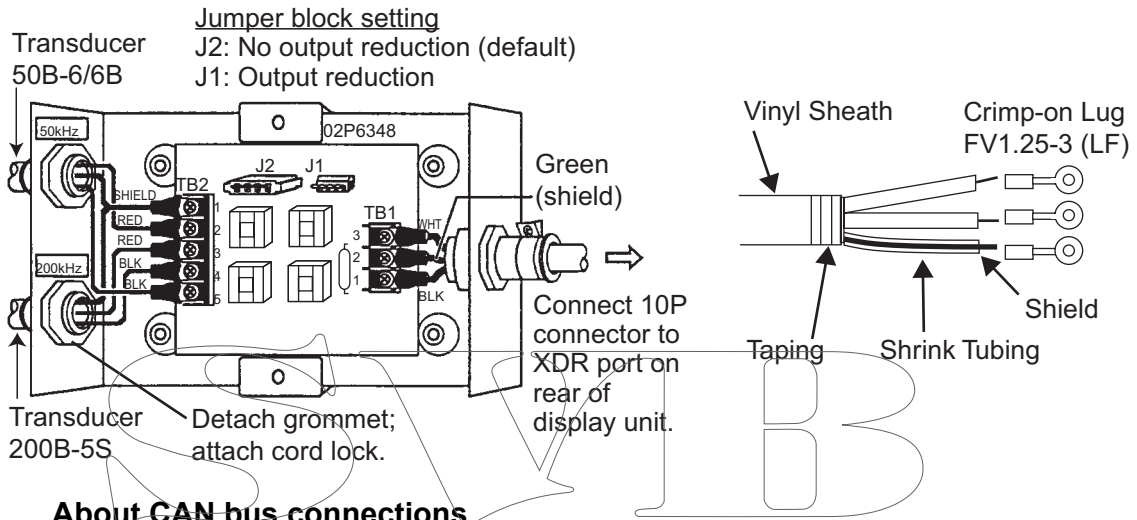

CAN bus is a communication protocol that shares multiple data and signals through a single backbone cable. You can simply connect any CAN bus devices onto the backbone cable to expand your network onboard. With CAN bus, IDs are assigned to all the devices in the network, and the status of each sensor in the network can be detected. All the CAN bus devices can be incorporated into the NMEA2000 network. For detailed information about CAN bus wiring, see "Furuno CAN bus Network Design Guide" (Type: TIE-00170) on Tech-Net, or contact your dealer.

13.6 Initial Settings

13.6.1 INSTALLATION SETTINGS menu

The first time the system is powered, the [INSTALLATION SETTINGS] menu appears.

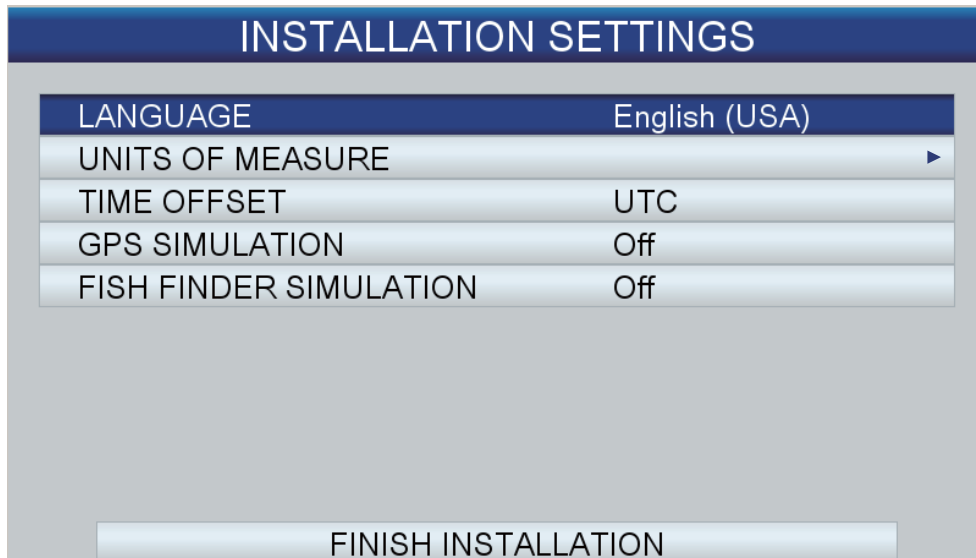

Enter basic settings, following the procedure below.

1. If your language is English USA, the default language, go to step 4.
2. [LANGUAGE] is selected; push the **RotoKey™** to show the language selection window.



3. Rotate the **RotoKey™** to select a language then push the key.

13. INSTALLATION

4. Rotate the **RotoKey™** to select [UNITS OF MEASURE] then push the key.

UNITS OF MEASURE	
<	
DISTANCE	NM
SPEED	kn
WIND SPEED	kn
DEPTH	ft
FISH SIZE	inch
TEMPERATURE	°F
AIR PRESSURE	hPa
OIL PRESSURE	kPa
FUEL	US gal

The units of measure are automatically changed according to the language selected. The available units are as shown in the table below.

Item	Available units	Item	Available units
DISTANCE	NM, SM, KM, NM+ft, NM+m, SM+ft	TEMPERATURE	°C, °F
SPEED	kn, mph, km/h	AIR PRESSURE	Bar, hPa
WIND SPEED	kn, m/s, mph, Bft	OIL PRESSURE	Bar, PSI, kPa
DEPTH	m, ft, fm, pb, HR	FUEL	l, UK gal, US gal
FISH SIZE	inch, cm		

To change a unit, rotate the **RotoKey™** to select the unit name then push the key. An options window for the unit selected appears. The right figure shows the units available for [DISTANCE]. Rotate the **RotoKey™** to select the unit to use then push the key.

NM
SM
km
NM+ft
NM+m
SM+ft

5. Press the **ESC/MENU** key to return to the [INSTALLATION SETTINGS] menu.
6. Time fed from the internal GPS navigator is UTC time. If you would rather use local time, follow the steps below to enter the time difference between your time and UTC time. Otherwise go to step 7.
- 1) Rotate the **RotoKey™** to select [TIME OFFSET] then push the key.

UTC + 0:00

- 2) Press the up or down arrow on the **CursorPad** to show a minus (-) sign or (+) sign. + sign if your time is ahead of UTC, or - sign if your time is behind UTC.
- 3) Press the right arrow on the **CursorPad** to put the cursor on the hour digit.
- 4) Press the up or down arrow on the **CursorPad** to set the hour.
- 5) If necessary, press the right arrow on the **CursorPad** to select the minute digit and use the **CursorPad** to set minutes.
- 6) Push the **RotoKey™** to finish.
7. Rotate the **RotoKey™** to select [FINISH INSTALLATION] then push the key.

13.6.2 CAN bus input/output

How to select CAN bus input and output data

1. Long-press the **ESC/MENU** key to open the menu.
2. Rotate the **RotoKey™** to select [INTERFACE] then push the key.
3. Use the **RotoKey™** to select [SELECT INPUT DEVICE] then push the key.

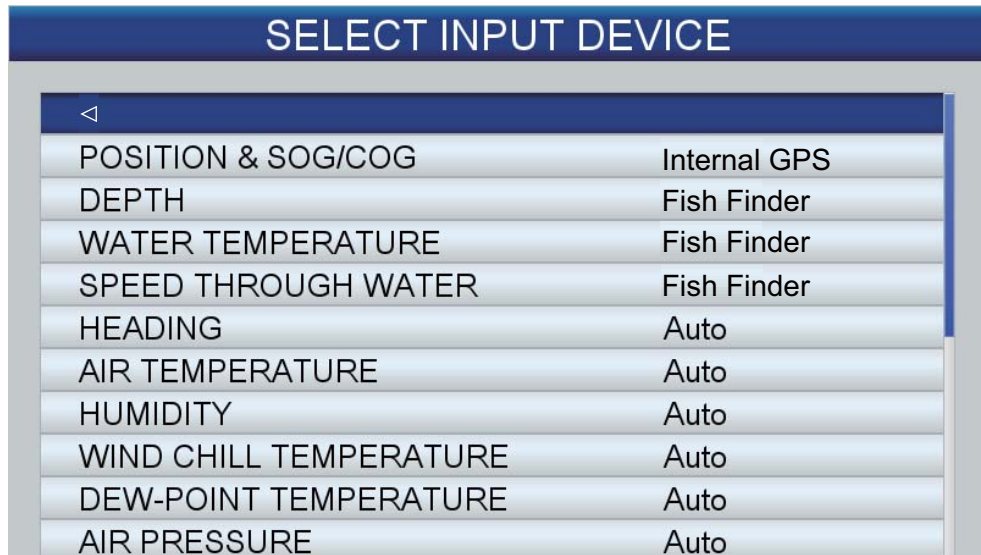

4. Select the data to input as follows:

- 1) Use the **RotoKey™** to select a data then push the key. For [POSITION & SOG/COG], [DEPTH], [WATER TEMPERATURE] and [SPEED THROUGH WATER], the following options windows appear.

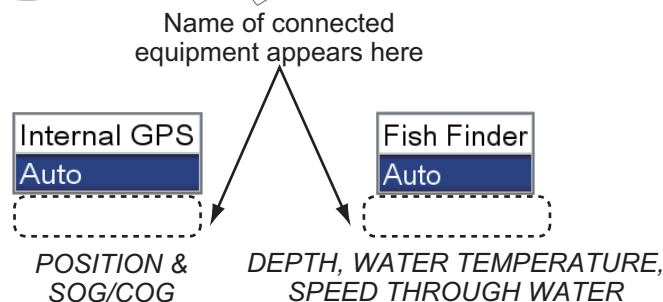

- 2) For [POSITION & SOG/COG]:

[Internal GPS]: Position fix is obtained via the internal GPS antenna (including optional GPS antenna).

[Auto]: Select if you have multiple external navigators connected and want to use them instead of the internal GPS. In this case, the navigator with the lowest IP address has priority.

If you have a FURUNO external navigator speed/course source connected, its name appears below [Auto]. Select the model name to have that device feed corresponding data.

- 3) For [DEPTH], [WATER TEMPERATURE] and [SPEED THROUGH WATER], Select [Fish Finder] to have the internal fish finder feed respective data. Select [Auto] when external sources are available and you want to use them instead of the internal fish finder. In this case, the device with the lowest IP address has priority.

13. INSTALLATION

If the external source is a FURUNO make, its name appears below [Auto]. Select the device name to have the device feed respective data.

- 4) Other items are selected to [Auto]. Respective data are input if associated device is connected to the system.
5. Press the **ESC/MENU** key to return to the [INTERFACE] menu.
6. Use the **RotoKey™** to select [SELECT OUTPUT PGN] then push the key.

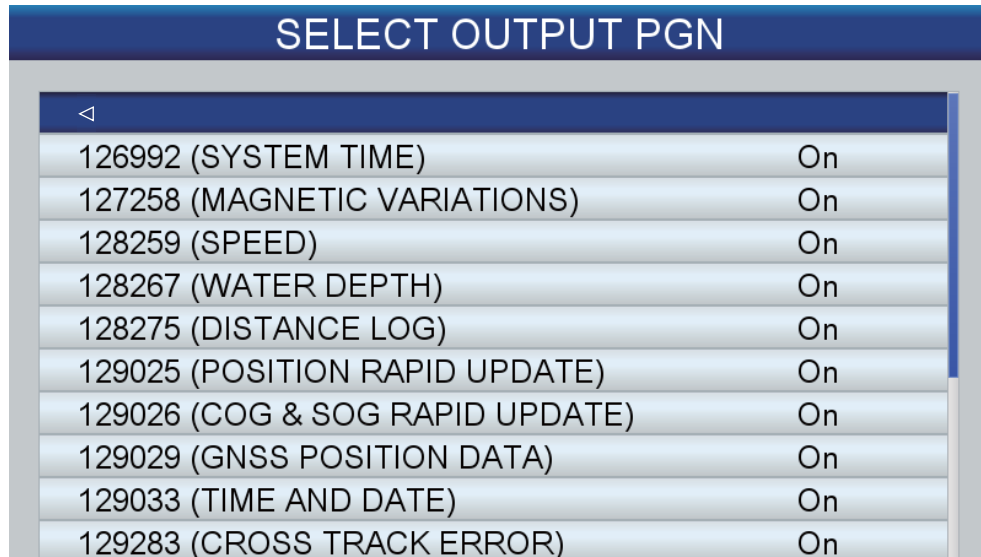

7. Use the **RotoKey™** to select an item then push the key.
8. Select [On] or [Off] as appropriate then push the **RotoKey™**.
9. Repeat steps 7 and 8 for remaining items.
10. Press the **ESC/MENU** key several times to close the menu.

CAN bus (NMEA 2000) input/output

Input PGN

PGN	Description
059392	ISO Acknowledgement
059904	ISO Request
060928	ISO Address Claim
061184	Self Test Group Function
126208	NMEA-Request Group Function
	NMEA-Command Group Function
	NMEA-Acknowledge Group Function
126992	System Time
126996	Product Information
127245	Rudder
127250	Vessel Heading
127251	Rate of Turn

PGN	Description
127488	Engine Parameters, Rapid Update
127489	Engine Parameters, Dynamic
127493	Transmission Parameters
127496	Trip Parameter, Vessel
127505	Fluid Level
128259	Speed
128267	Water Depth
129025	Position, Rapid Update
129026	COG & SOG, Rapid Update
129029	GNSS Position Data
129033	Time & Date
129038	AIS Class A Position Report
129039	AIS Class B Position Report
129040	AIS Class B Extended Position Report
129291	Set & Drift, Rapid Update
129538	GNSS Control Status
129540	GNSS Sats in View
129793	AIS UTC and Date Report
129794	AIS Class A Static and Voyage Related Data
129798	AIS SAR Aircraft Position Report
129808	DSC Call Information
129809	AIS Class B "CS" Static Data Report, Part A
129810	AIS Class B "CS" Static Data Report, Part BA
130306	Wind Data
130310	Environmental Parameters
130311	Environmental Parameters
130312	Temperature
130313	Humidity
130314	Actual Pressure
130577	Direction Data

13. INSTALLATION

Output PGN

PGN	Description	Output cycle (msec)
059392	ISO Acknowledgement	
059904	ISO Request	
060928	ISO Address Claim	
126208	NMEA-Request Group Function	
	NMEA-Command Group Function	
	NMEA-Acknowledge Group Function	
126464	Transmit PGN's Group Function	
126992 ^{*1}	System Time	1000
126996	Production Information	
127258 ^{*1}	Magnetic Variation	1000
128259	Speed (Requires speed sensor)	1000
128267	Water Depth	1000
128275 ^{*1}	Distance Log	1000
129025 ^{*1}	Position, Rapid Update	100
129026 ^{*1}	COG & SOG, Rapid Update	250
129029 ^{*1}	GNSS Position Data	1000
129033 ^{*1}	Time & Date	1000
129283 ^{*2}	Cross Track Error	1000
129284 ^{*2}	Navigation Data	1000
129285 ^{*2}	Navigation - Route/WP	1000
130310	Environmental Parameters (Requires temperature sensor)	1000
130312	Temperature (Requires temperature sensor)	2000
130830	Target Information	
130831	Bottom Classification	
130832	Fish Length	

^{*1} Output when [POSITION & SOG/COG] in [SELECT INPUT DEVICE] of the [INTERFACE] menu is selected to [Internal GPS] and the position-fixing mode indication is other than "NO FIX".

^{*2} Must be set to output waypoint information (L/L position, etc.)

APPENDIX 1 MENU TREE

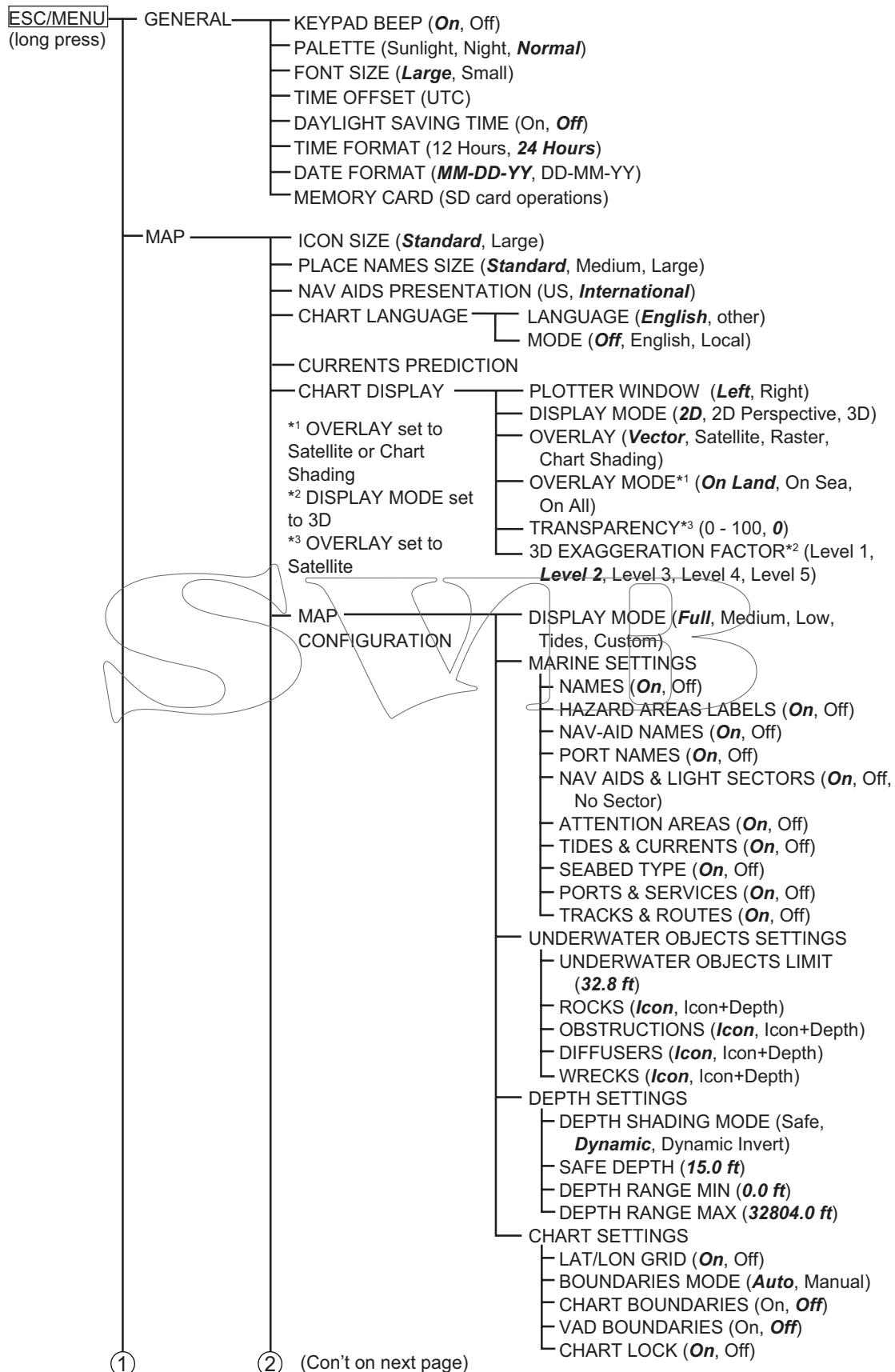

APPENDIX 1 MENU TREE

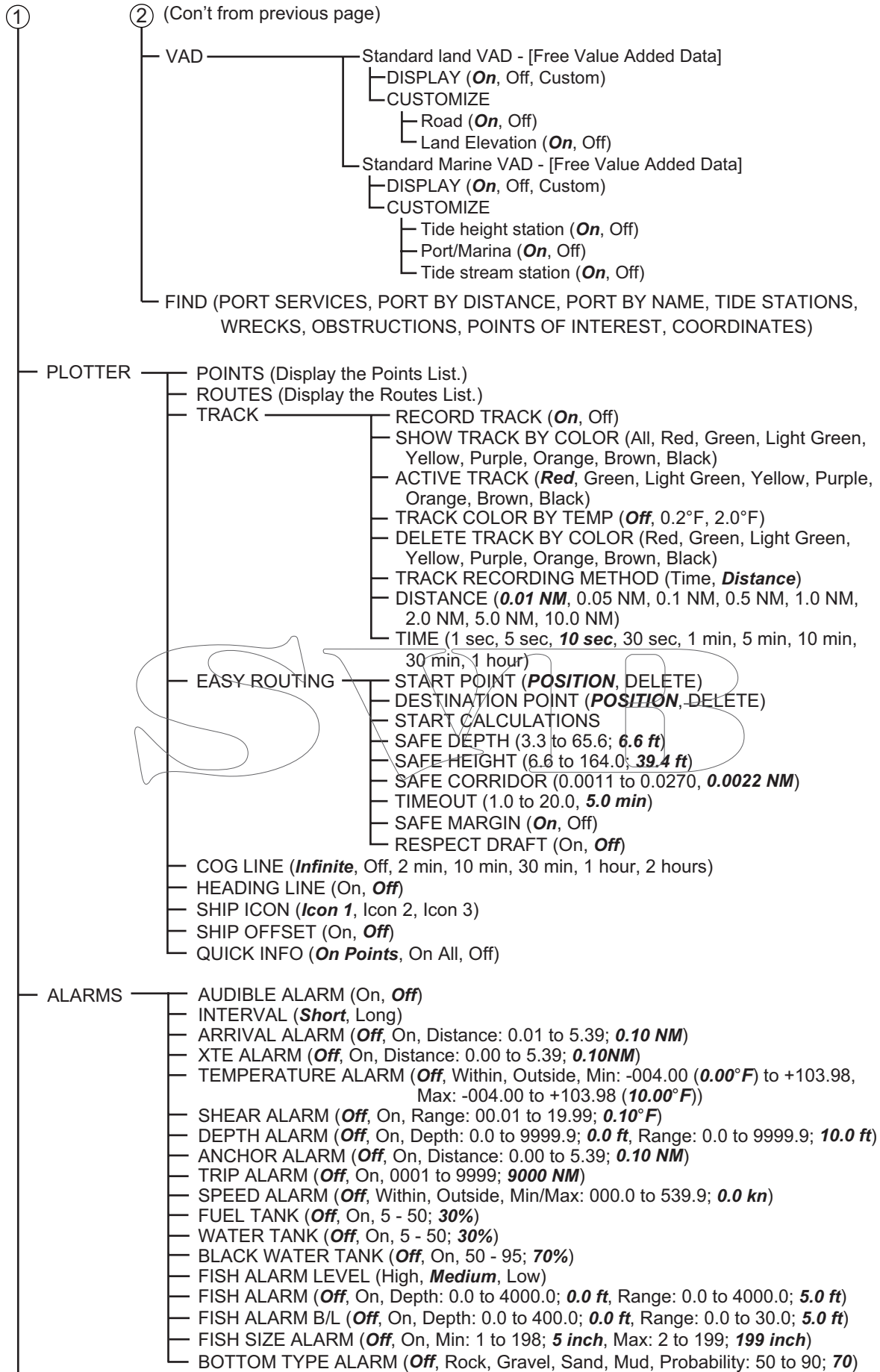

① (Con't from previous page)

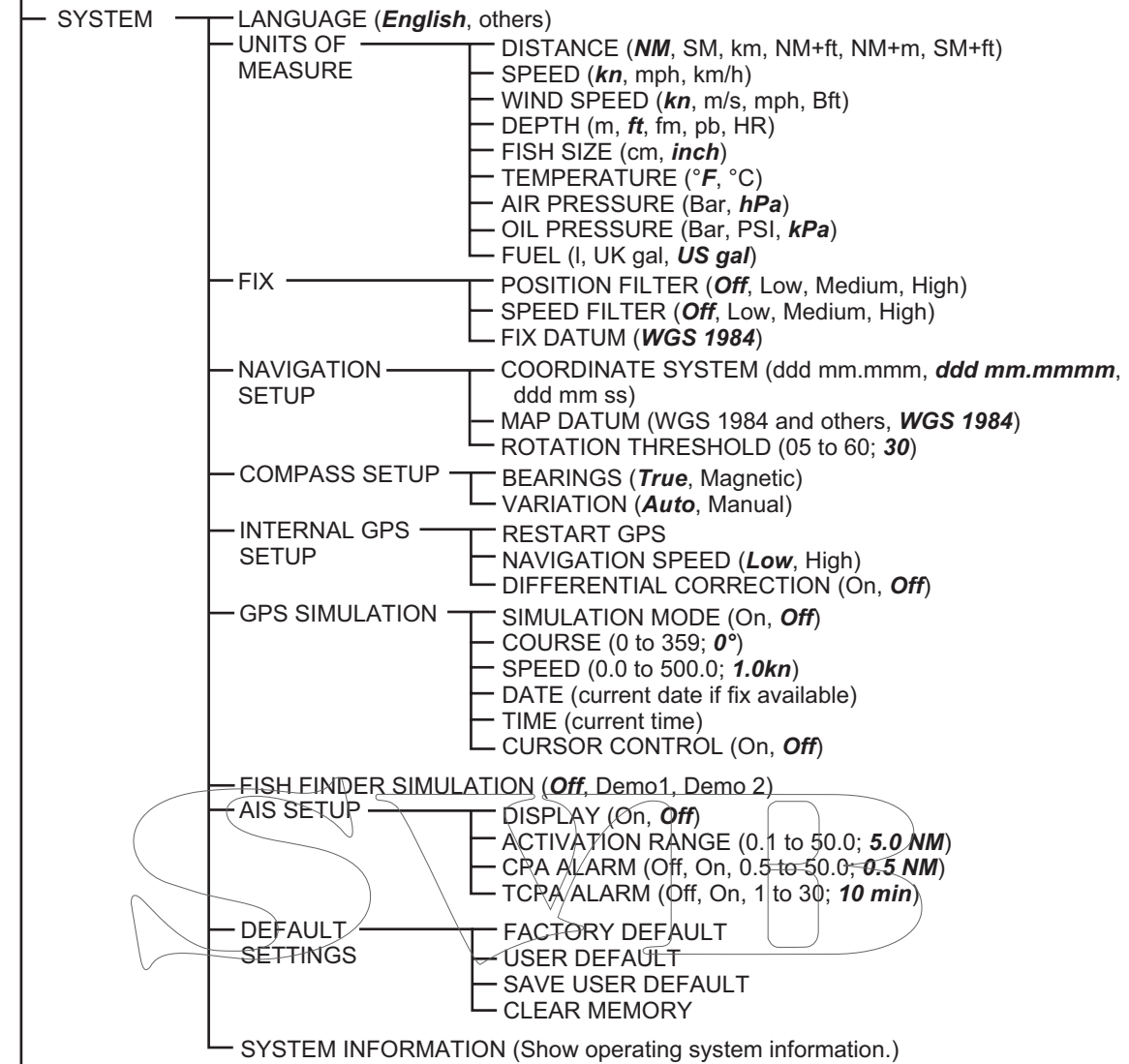

① (Con't on next page)

APPENDIX 1 MENU TREE

① (Con't from previous page)

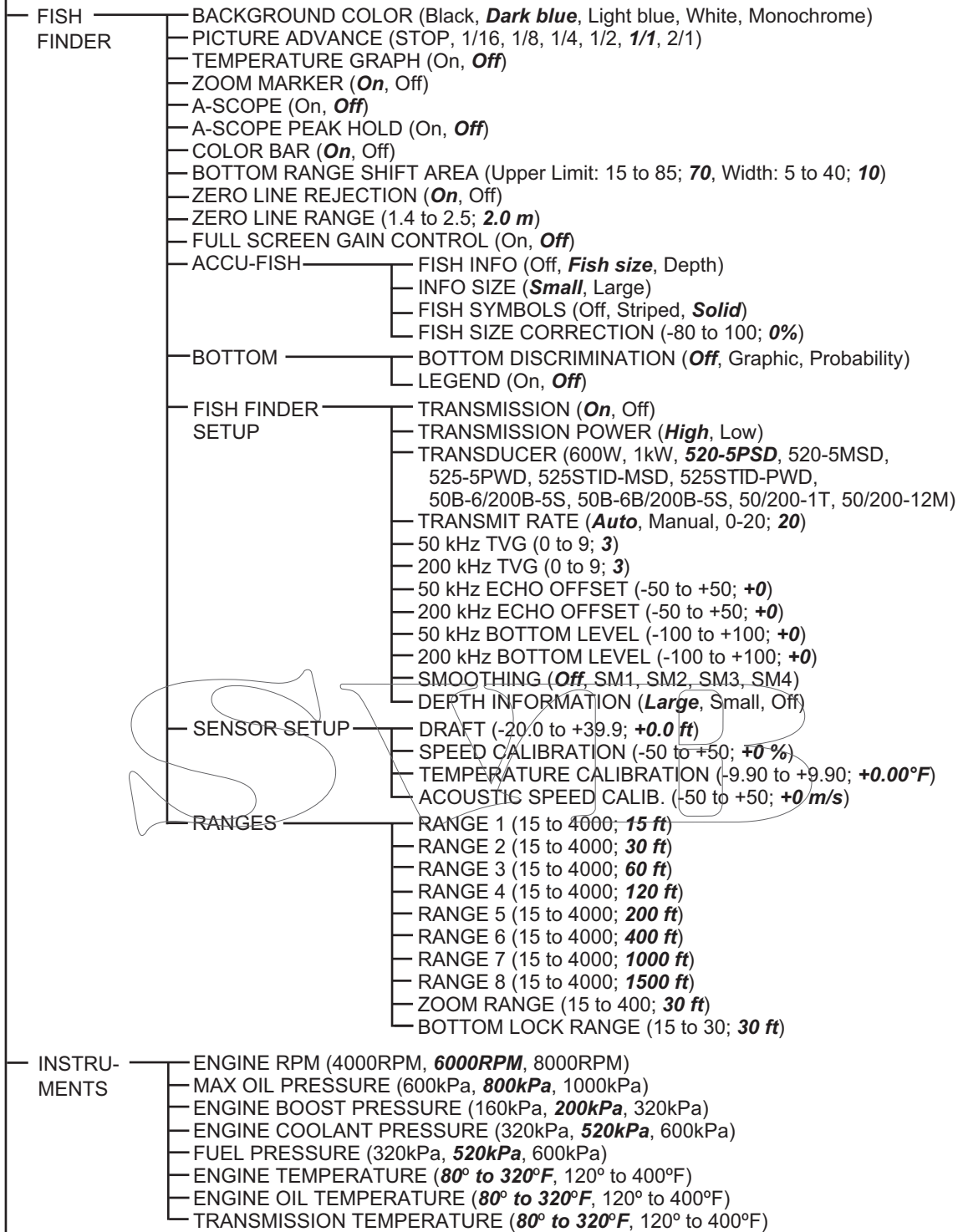

① (Con't on next page)

① (Con't from previous page)

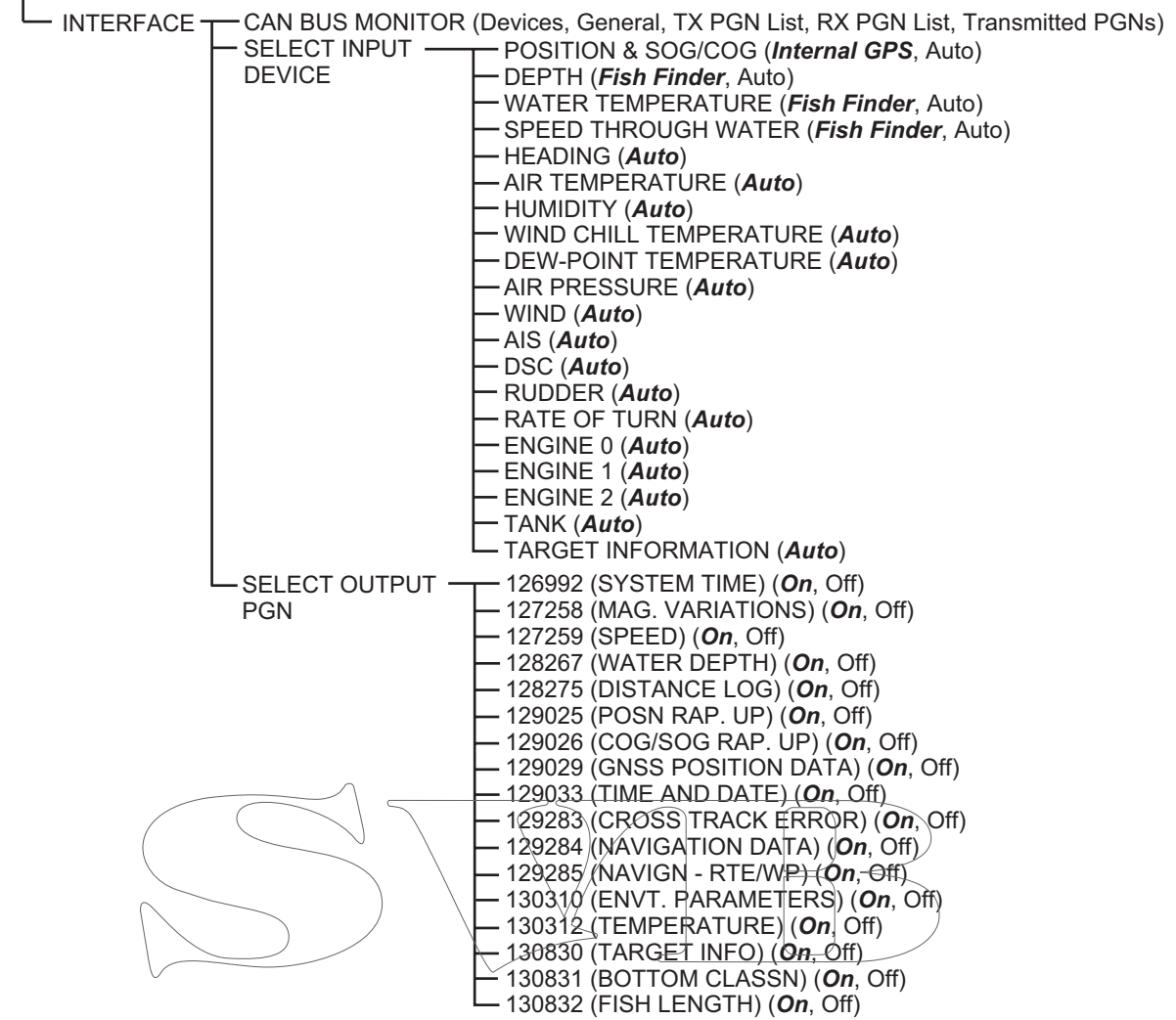

APPENDIX 2 ABBREVIATIONS, SYMBOLS

Abbreviations

Abbreviation	Meaning
2D	Two Dimensional
3D	Three Dimensional
A-PRS	Air Pressure
A-TMP	Air Temperature
AIS	Automatic Identification System
AM	Ante Meridiem
AOR	Atlantic Ocean Region
AUTO	Automatic
B-type	Bottom type
Bar	Barometric
Bft	Beaufort
BIOS	Basic Input/Output System
BOOST	Engine Boost Pressure
BRG	Bearing
C	Celsius
C-TMP	Wind-Chill Temperature
C-MAP	Registered trademark of the Jeppesen Corporation
CAN BUS	Controller Area Network Bus
cm	centimeter
COG	Course Over the Ground
COOL-P	Engine Coolant Pressure
CPA	Closest Point of Approach
CTRL	Control
DATE	Date
DD	Day
Demo	Demonstration
DEPTH	Depth
DEW-P	Dew-Point Temperature
DIR	Direction
DOP	Dilution of Precision
DSC	Digital Selective Call
DST	Distance
DST-E	Distance to Empty
E	East
E-SPD	Engine Speed
E-TMP	Engine Temperature
ELV	Elevation
ESC	Escape
ETA	Estimated Time of Arrival
F	Fahrenheit











Abbreviation	Meaning
FF	Fast File
fm	fathoms
ft	feet
FUEL	Fuel Rate
FUEL-P	Fuel Pressure
FUEL-R	Fuel Rate
GAIN H	Gain High (frequency)
GAIN L	Gain Low (frequency)
gal	gallon
GNSS	Global Navigation Satellite System
GPS	Global Positioning System
HDG	Heading
HDOP	Horizontal Dilution of Precision
h	hour
HOURL	Total Engine Hours
hPa	Hectopascal
HR	Hiro
HUMID	Humidity
IOR	Indian Ocean Region
JP	Japan
kHz	kilohertz
KM	kilometer
km/h	kilometer/hour
KNT	knot
kPa	Kilo Pascal
LAT	Latitude
Lib	Library
LOAD	Engine Load
LON	Longitude
m	meter
m/s	meters/second
M	Magnetic
Max	Maximum
Min	Minimum
min	minute
MM	Month
MOB	ManOverBoard
mph	mile per hour
N	North
NAD	North American Datum
NAV	Navigation
NGA	National Despoliation Intelligence Agency
NM	Nautical Mile
O-PRS	Engine Oil Pressure
O-TMP	Engine Oil Temperature
ODO	Odometer
OS	Operating System
pb	Passi Braza
PGN	Parameter Group Number

APPENDIX 2 ABBREVIATIONS, SYMBOLS

Abbreviation	Meaning
PM	Post Meridiem
POR	Pacific Ocean Region
POS	Position
PSI	Per Square Inch
PT	Point
QP	Quick Point
RES	Resolution
ROT	Rate Of Turn
RT	Route
RUDDR	Rudder
S	South
SD	Secure Digital
SDHC	Secure Digital High capacity
SDK	Software Development Kit
sec	second(s)
SIM	Simulation
SL	Satellite
SM	statute mile
SOG	Speed Over the Ground
STW	Speed Through Water
SYM	Symbol
T	True
T-PRS	Transmission Oil Pressure
T-TMP	Transmission Temperature
TCPA	Time to Closest Point of Approach
TEMP	Temperature
TIME	Time
TRIM	Engine Trim
TRIP	Trip
TTG	Time To Go
UK	United Kingdom
US	United States
UTC	Universal Time Coordination
V	Version
VAD	Value Added Data
VDOP	Vertical Dilution of Precision
W	Watt, West
WAAS	Wide Area Augmentation System
WDA	Wind Direction Apparent
WDT	Wind Direction True
WGS	World Geodetic System
WPT	Waypoint
WSA	Wind Speed Apparent
WST	Wind Speed True
XTE	Cross Track Error
YY	Year

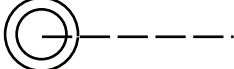















Symbols

Plotter display symbols

Item	Symbol
Cursor (two types)	 : Active  : Inactive (red)
MOB (ManOverBoard) mark	 (red)
Ship icon (three types)	   <i>Icon 1 Icon 2 Icon 3</i>
Ship icon+COG line	
Ship icon+Heading line	 (red)
Ship icon+track	
Point (single point and route point)	 (default: yellow)

APPENDIX 2 ABBREVIATIONS, SYMBOLS

Alarm symbols

ALARM	SYMBOL	ALARM	SYMBOL
ARRIVAL ALARM		FISH ALARM (B/L)	
ANCHOR ALARM		FISH SIZE	
CROSS TRACK ERROR		BOTTOM TYPE	
SPEED ALARM		FUEL TANK	
TRIP ALARM		WATER TANK	
TEMPERATURE ALARM		BLACK-WATER TANK	
SHEAR ALARM		CPA ALARM	
DEPTH ALARM		TCPA ALARM	
FISH ALARM			

SVIB

APPENDIX 3 JIS CABLE GUIDE

Cables listed in the manual are usually shown as Japanese Industrial Standard (JIS). Use the following guide to locate an equivalent cable locally.

JIS cable names may have up to 6 alphabetical characters, followed by a dash and a numerical value (example: DPYC-2.5). For core types D and T, the numerical designation indicates the *cross-sectional Area (mm²)* of the core wire(s) in the cable. For core types M and TT, the numerical designation indicates the *number of core wires* in the cable.

- | | | |
|--|-----------------------------|-----------------------|
| 1. Core Type | 2. Insulation Type | 3. Sheath Type |
| D Double core power line | P Ethylene Propylene Rubber | Y PVC (Vinyl) |
| T Triple core power line | | |
| M Multi core | | |
| TT Twisted pair communications (1Q=quad cable) | | |

- | | | |
|----------------------|------------------------------|--|
| 4. Armor Type | 5. Sheath Type | 6. Shielding Type |
| C Steel | Y Anticorrosive vinyl sheath | SLA All cores in one shield, plastic tape w/aluminum tape |
| | | -SLA Individually shielded cores, plastic tape w/aluminum tape |

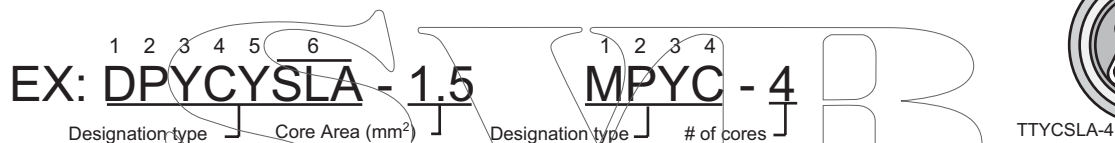
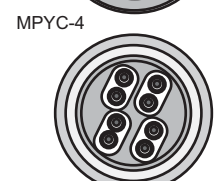

The following reference table lists gives the measurements of JIS cables commonly used with Furuno products:

Type	Core		Cable Diameter	Type	Core		Cable Diameter
	Area	Diameter			Area	Diameter	
DPYC-1.5	1.5mm ²	1.56mm	11.7mm	TPYCY-1.5	1.5mm ²	1.56mm	14.5mm
DPYC-2.5	2.5mm ²	2.01mm	12.8mm	TPYCY-2.5	2.5mm ²	2.01mm	15.5mm
DPYC-4	4.0mm ²	2.55mm	13.9mm	TPYCY-4	4.0mm ²	2.55mm	16.9mm
DPYC-6	6.0mm ²	3.12mm	15.2mm	TPYCSLA-1.5	1.5mm ²	1.56mm	13.9mm
DPYC-10	10.0mm ²	4.05mm	17.1mm	TTYC-7SLA	0.75mm ²	1.11mm	20.8mm
DPYC-16	16.0mm ²	5.10mm	19.4mm	TTYCSLA-1	0.75mm ²	1.11mm	9.4mm
DPYCY-1.5	1.5mm ²	1.56mm	13.7mm	TTYCSLA-1Q	0.75mm ²	1.11mm	10.8mm
DPYCY-2.5	2.5mm ²	2.01mm	14.8mm	TTYCSLA-4	0.75mm ²	1.11mm	15.7mm
DPYCY-4	4.0mm ²	2.55mm	15.9mm	TTYCY-4SLA	0.75mm ²	1.11mm	19.5mm
DPYCSLA-1.5	1.5mm ²	1.56mm	11.9mm	TTYCSLA-1	0.75mm ²	1.11mm	11.2mm
DPYCSLA-2.5	2.5mm ²	2.01mm	13.0mm	TTYCSLA-4	0.75mm ²	1.11mm	17.9mm
MPYC-2	1.0mm ²	1.29mm	10.0mm				
MPYC-4	1.0mm ²	1.29mm	11.2mm				
MPYC-7	1.0mm ²	1.29mm	13.2mm				
MPYCY-12	1.0mm ²	1.29mm	19.0mm				
MPYCY-19	1.0mm ²	1.29mm	22.0mm				

This page is intentionally left blank.

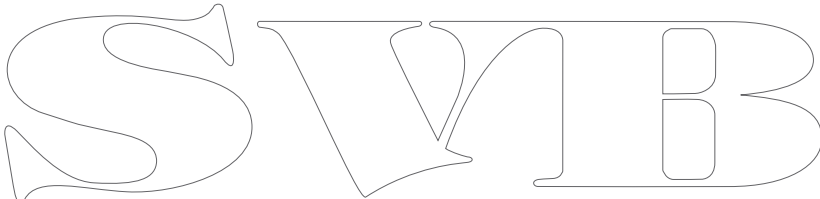

**SPECIFICATIONS OF GPS PLOTTER/SOUNDER
GP-1670F/1870F**

1 GENERAL

- 1.1 Display
 - GP-1670F 5.7-inch TFT color LCD, 640 x 480 dots
 - GP-1870F 7.0-inch TFT color LCD, 800 x 480 dots
- 1.2 Display mode Plotter, Plotter/Sounder, Sounder, Highway, Waypoint display
- 1.3 Projection Mercator
- 1.4 Useable area 80° latitude or below
- 1.5 Language Bahasa Indonesia, Bahasa Malaysia, Chinese, Danish, English (UK/USA), Finnish, French, German, Greek, Italian, Japanese, Norwegian, Polish, Portuguese, Russian, Spanish, Swedish, Thai, Vietnamese
- 1.6 Brilliance
 - GP-1670F 800 cd/m² typical
 - GP-1870F 900 cd/m² typical

2 GPS RECEIVER

- 2.1 Receiving channels GPS: 50 channels, SBAS: 1 channel
- 2.2 Rx frequency 1575.42 MHz
- 2.3 Rx code C/A code, WAAS
- 2.4 Position fixing system All in view
- 2.5 Accuracy GPS 10 m, SBAS 7.5 m
- 2.6 Cold start 90 s approx.
- 2.7 Update interval 1 s
- 2.8 Receiving sensitivity -150 dBm
- 2.9 SBAS WAAS, EGNOS and MSAS

3 PLOTTER FUNCTION

- 3.1 Effective projection area 0.125 NM to 2,048 NM (at equatorial area)
- 3.2 SD card 32 GB max., C-MAP 4D chart
- 3.3 Track display Plot interval: by time or distance
- 3.4 Memory capacity Track: 30,000 points, Waypoint: 30,000 points, Course: 1,000 route
- 3.5 AIS information 200 points
- 3.6 Weather information Wind, Wave, Weather type, Humidity and Temperature
- 3.7 Equipments monitor Engine monitor, Instruments information

4 SOUNDER

- 4.1 Transmit frequency 50/200 kHz
- 4.2 Transmit method Single or alternative transmission
- 4.3 Transmission power 600 W/ 1kW rms selectable
- 4.4 Transmission interval 2000 times/min.
- 4.5 Pulselength 0.04 to 3.0 ms
- 4.6 Receiving sensitivity 10 dBμV

- 4.7 Range Basic range: 5 to 1200 m, Shift: 0 to 1200 m
- 4.8 Picture advance speed 7 steps
- 4.9 Other functions ACCU-FISH™, A-scope, bottom discrimination, Automatic mode (cruising/fishing)

5 INTERFACE

- 5.1 I/O port CAN bus, USB for maintenance
- 5.2 Data format IEC61162-1/NMEA Ver1.5/2.0/3.0 (data converter required)
- 5.3 Data sentences
 - Input GGA, GLL, HDG, HDT, MDA, MTW, MWV, RMA, RMB, RMC, VHW, VTG, ZDA
 - Output DBT,DPT,MTW*,TLL*,VHW* (*: external data required)
- 5.4 CAN bus PGN (NMEA2000)
 - Input 059392/904, 060928, 061184, 126208/992/996, 127245/250/251/488/489/493/496/505, 128259/267, 129025/026/029/033/038/039/040/538/540/793/794/798, 129808/809/810, 130306/310/311/312/313/314/577
 - Output 059392/904, 060928, 126208/464/992/996, 127258, 128259/267/275, 129025/026/029/033/283/284/285, 130310/312/830/831/832

6 POWER SUPPLY

- 6.1 Display unit
 - GP-1670F 12-24 VDC: 0.9-0.5 A
 - GP-1870F 12-24 VDC: 1.0-0.5 A
- 6.2 Rectifier (PR-62, option) 100/110/115/220/230 VAC, 1 phase, 50/60Hz

7 ENVIRONMENTAL CONDITIONS

- 7.1 Ambient temperature -15°C to +55°C
- 7.2 Relative humidity 93% or less at +40°C
- 7.3 Degree of protection IP56

PACKING LIST GP-1670F-E

14CWF-X-9852-1

1/1

NAME	OUTLINE	DESCRIPTION/CODE No.	Q'TY
ユニット			
GPS7 ロック/魚探		GP-1670F	1
GPS PLOTTER/SOUNDER		999-999-194-00	(*)
予備品			
ヒューズ		0312 003. MXP	1
GLASS TUBE FUSE		999-999-186-00	(*)
付属品			
ノブ		VTSPKNOB-M6 FRN	2
KNOB		999-999-197-00	(*)
ハンガ-		HBS47A	1
EXTERNAL BRACKET		999-999-184-00	(*)
フィルタークリーナー		MINU CLOTH FRN	1
CLEANING CLOTH		999-999-183-00	(*)
工事材料			
Fマウントネジ キット		K10LC3005A	4
FLUSH MOUNT SCREWS KIT		999-999-180-00	(*)
Fマウントパッキン		HGB10AX	1
FLUSH MOUNT GASKET		999-999-181-00	(*)

NAME	OUTLINE	DESCRIPTION/CODE No.	Q'TY
ケーブル(クミピン) MJ		MJ-A3SPF0013A-035C	1
CABLE ASSEMBLY		000-176-666-10	
クランプネジ		VTATM4. 8X22 TCC INX	4
EXTERNAL BRACKET FIXING SCREWS		999-999-179-00	(*)
図書			
フラッシュマウント型紙		C42-01201-*	1
FLUSH MOUNTING TEMPLATE		999-999-187-00	(*)
取扱説明CD		GP-1X70 O/M *CD-ROM*	1
OPERATOR'S MANUAL CD		999-999-190-00	(*)
操作要領書(英/和)		OS*-44770-*	1
OPERATOR'S GUIDE (E/J)		999-999-189-00	(*)
装備要領書		IMC-44770-*	1
INSTALLATION MANUAL		999-999-192-00	(*)

(*)は、タミコードに付き、注文できません。
 (*) THIS CODE CANNOT BE ORDERED.

型式/コード番号が2段の場合、下段より上段に代わる過渡期品であり、どちらかが入っています。なお、品質は変わりません。
 TWO TYPES AND CODES MAY BE LISTED FOR AN ITEM. THE LOWER PRODUCT MAY BE SHIPPED IN PLACE OF THE UPPER PRODUCT. QUALITY IS THE SAME.

(略図の寸法は、参考値です。DIMENSIONS IN DRAWING FOR REFERENCE ONLY.)

PACKING LIST GP-1870F-E

14CX-X-9852-1

1/1

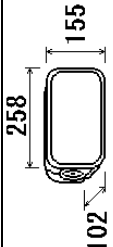
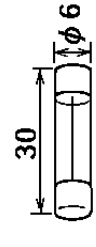
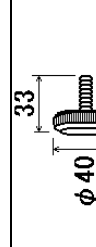
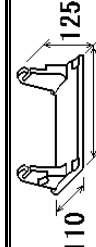
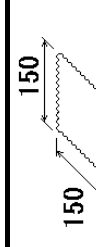
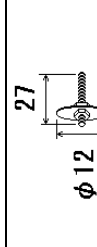
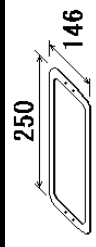
NAME	OUTLINE	DESCRIPTION/CODE No.	Q'TY
ユニット			
GPS7 ロック/魚探		GP-1870F	1
GPS PLOTTER/SOUNDER		999-999-196-00	(*)
予備品			
SPARE PARTS			
ヒューズ		0312 003.MXP	1
GLASS TUBE FUSE		999-999-186-00	(*)
付属品			
ACCESSORIES			
ノブ		VTSPKNOB-M6 FRN	2
KNOB		999-999-197-00	(*)
ハンガ-		HBS48AX	1
EXTERNAL BRACKET		999-999-185-00	(*)
フィルタークリーナー		MINU CLOTH FRN	1
CLEANING CLOTH		999-999-183-00	(*)
工事材料			
INSTALLATION MATERIALS			
Fマウントネジ キット		K10LC3005A	4
FLUSH MOUNT SCREWS KIT		999-999-180-00	(*)
Fマウントパッキン		HGB11AX	1
FLUSH MOUNT GASKET		999-999-182-00	(*)

(*)は、タミコードに付き、注文できません。

(*) THIS CODE CANNOT BE ORDERED.

(略図の寸法は、参考値です。DIMENSIONS IN DRAWING FOR REFERENCE ONLY.)

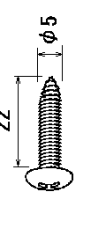
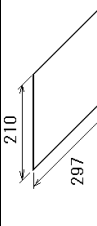
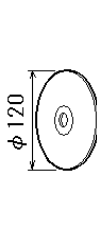
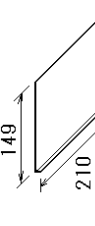
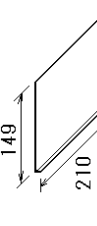
NAME	OUTLINE	DESCRIPTION/CODE No.	Q'TY
ケーブル(タミピン) MJ		MJ-A3SPF0013A-035C	1
CABLE ASSEMBLY		000-176-666-10	
タミピン		VTATM4. 8X22 TCC INX	4
EXTERNAL BRACKET FIXING SCREWS		999-999-179-00	(*)
図書			
DOCUMENT			
フラッシュマウント型紙		C42-01201-*	1
FLUSH MOUNTING TEMPLATE		999-999-187-00	(*)
取扱説明CD		GP-1X70 O/M *CD-ROM*	1
OPERATOR'S MANUAL CD		999-999-190-00	(*)
操作要領書(英/和)		OS*-44770-*	1
OPERATOR'S GUIDE (E/J)		999-999-189-00	(*)
装備要領書		IMC-44770-*	1
INSTALLATION MANUAL		999-999-192-00	(*)

型式/コード番号が2段の場合、下段より上段に代わる過渡期品であり、どちらかが入っています。なお、品質は変わりません。

TWO TYPES AND CODES MAY BE LISTED FOR AN ITEM. THE LOWER PRODUCT MAY BE SHIPPED IN PLACE OF THE UPPER PRODUCT. QUALITY IS THE SAME.

☆

A-2

C4479-Z01-B

表1 TABLE 1

寸法区分 (mm) DIMENSION	公差 (mm) TOLERANCE
L ≤ 50	±1.5
50 < L ≤ 100	±2.5
100 < L ≤ 500	±3

表2 TABLE 2

型式 MODEL	質量 MASS	MASS(kg±10%)
GP-1670	1.5	
GP-1670F	1.6	

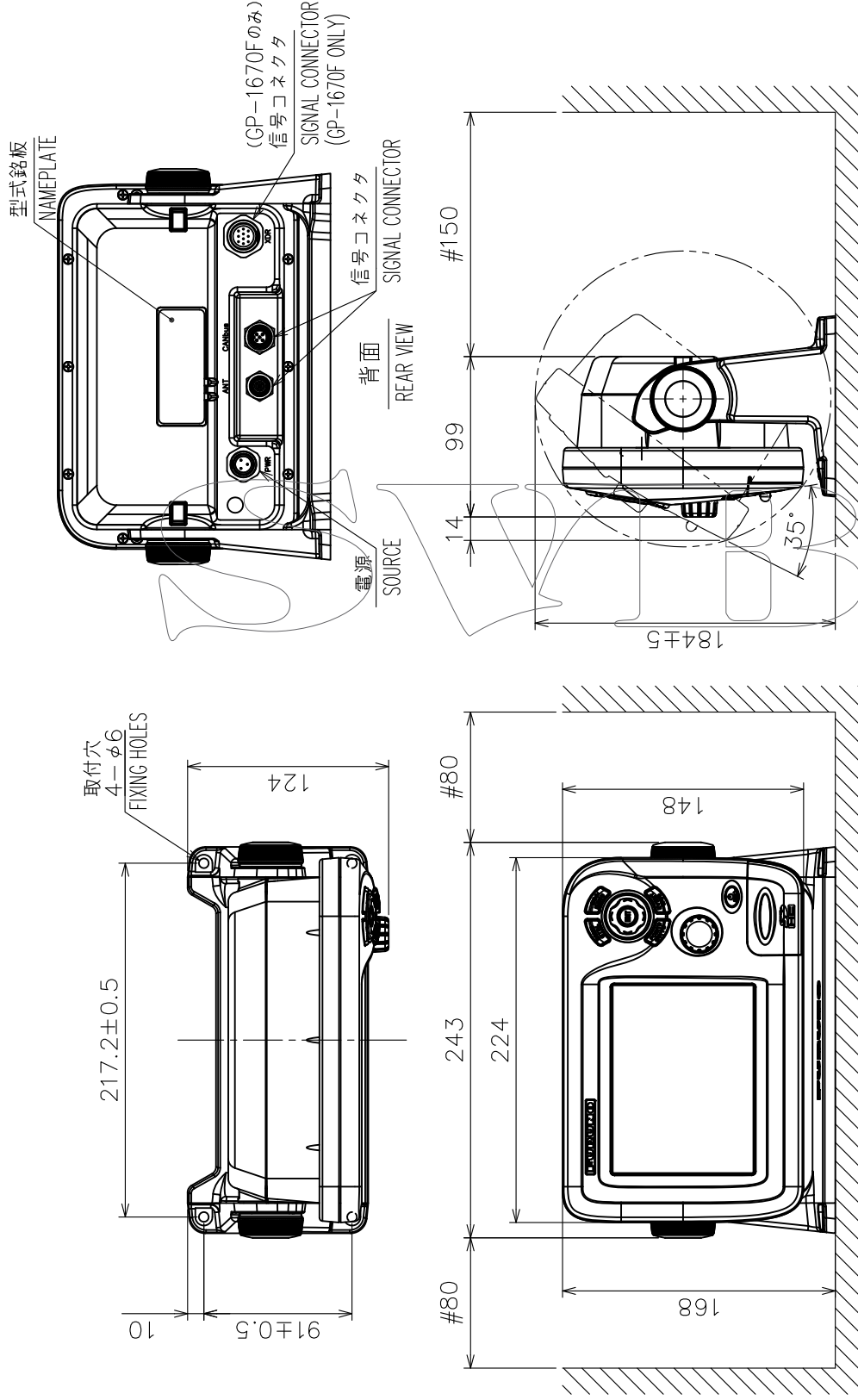

注 記

- 1) 指定外の寸法公差は表1による。
- 2) #印寸法は最小サービスクリアランスとする。
- 3) 取付用ネジはトラスターピッチ呼び径5を使用のこと。

NOTE

1. TABLE 1 INDICATES TOLERANCE OF DIMENSIONS WHICH IS NOT SPECIFIED.
2. #: MINIMUM SERVICE CLEARANCE.
3. USE TAPPING SCREWS φ4.8x22 FOR FIXING THE UNIT.

DRAWN	4/Apr/2012	T.YAMASAKI	TITLE	GP-1670/1670F
CHECKED	4/Apr/2012	H.MAKI	名称	指示部 (卓上装備)
APPROVED	6/Apr/2012	H. Maki	外寸図	
SCALE	1/4	質量 表2参照 SEE TABLE 2	NAME	DISPLAY UNIT (TABLETOP MOUNT)
DWG.No.	C4477-G01-A	REF.No.	14-079-100G-1	OUTLINE DRAWING

表1 TABLE 1

寸法区分 (mm) DIMENSION	公差 (mm) TOLERANCE
L ≤ 50	±1.5
50 < L ≤ 100	±2.5
100 < L ≤ 500	±3

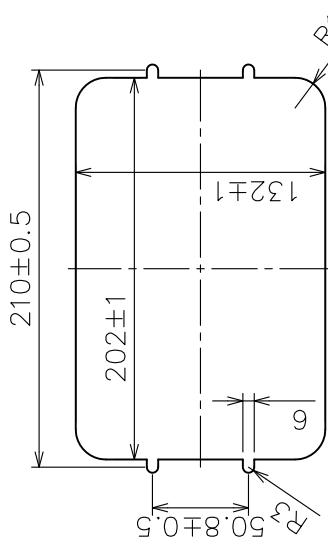

取付穴寸法図
CUTOUT DIMENSIONS

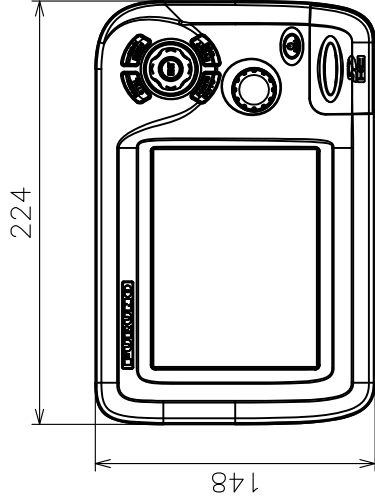
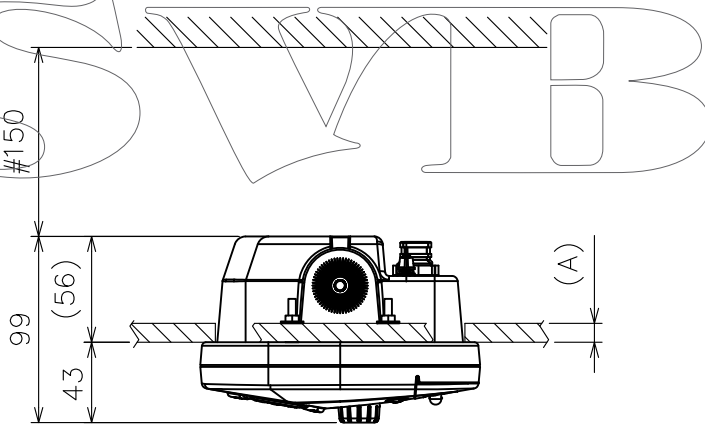
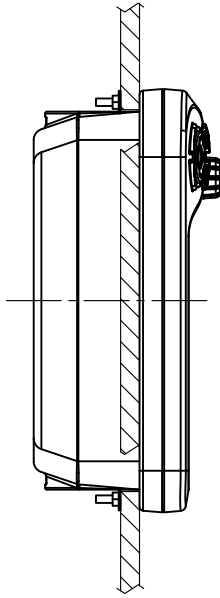
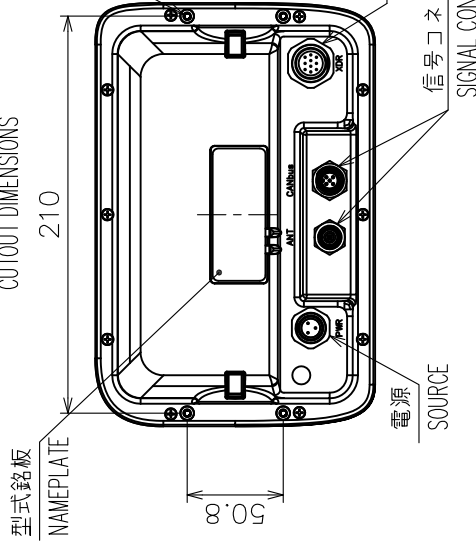

注記

- 1) 指定外の寸法公差は表1による。
- 2) #印寸法は最小サービス空間寸法とする。
- 3) 壁の厚さ(A)は $5 \leq A \leq 18$ とする。
取付には寸切ボルトM4×30、M4座金・ナットを使用のこと。
筐体にはネジ部を8mm以上入れないこと。

NOTE

1. TABLE 1 INDICATES TOLERANCE OF DIMENSIONS WHICH IS NOT SPECIFIED.
2. #: MINIMUM SERVICE CLEARANCE.
3. BULKHEAD THICKNESS (A): $5 \leq A \leq 18$. USE STUD BOLT M4×30, M4 WASHER/NUT. DO NOT SCREW INTO THE UNIT 8mm OR MORE.

表2 TABLE 2

型式	MODEL	質量	MASS(kg±10%)
GP-1670	GP-1670	1.2	
GP-1670F	GP-1670F	1.3	

DRAWN	4/Apr/2012	T.YAMASAKI	TITLE	GP-1670/1670F
CHECKED	4/Apr/2012	H.MAKI	名称	指示部 (埋込装備)
APPROVED	6/Apr/2012	H. Maki	外寸図	
SCALE	1/4	質量 表2参照 SEE TABLE 2	NAME	DISPLAY UNIT (FLUSH MOUNT)
DWG.No.	C4477-G02-A	REF.No.	14-079-101G-1	OUTLINE DRAWING

表1 TABLE 1

寸法区分 (mm) DIMENSION	公差 (mm) TOLERANCE
L ≤ 50	±1.5
50 < L ≤ 100	±2.5
100 < L ≤ 500	±3

表2 TABLE 2

型式 MODEL	質量 MASS	容積率 VOLUME (%)
GP-1870	1.5	10%
GP-1870F	1.6	10%

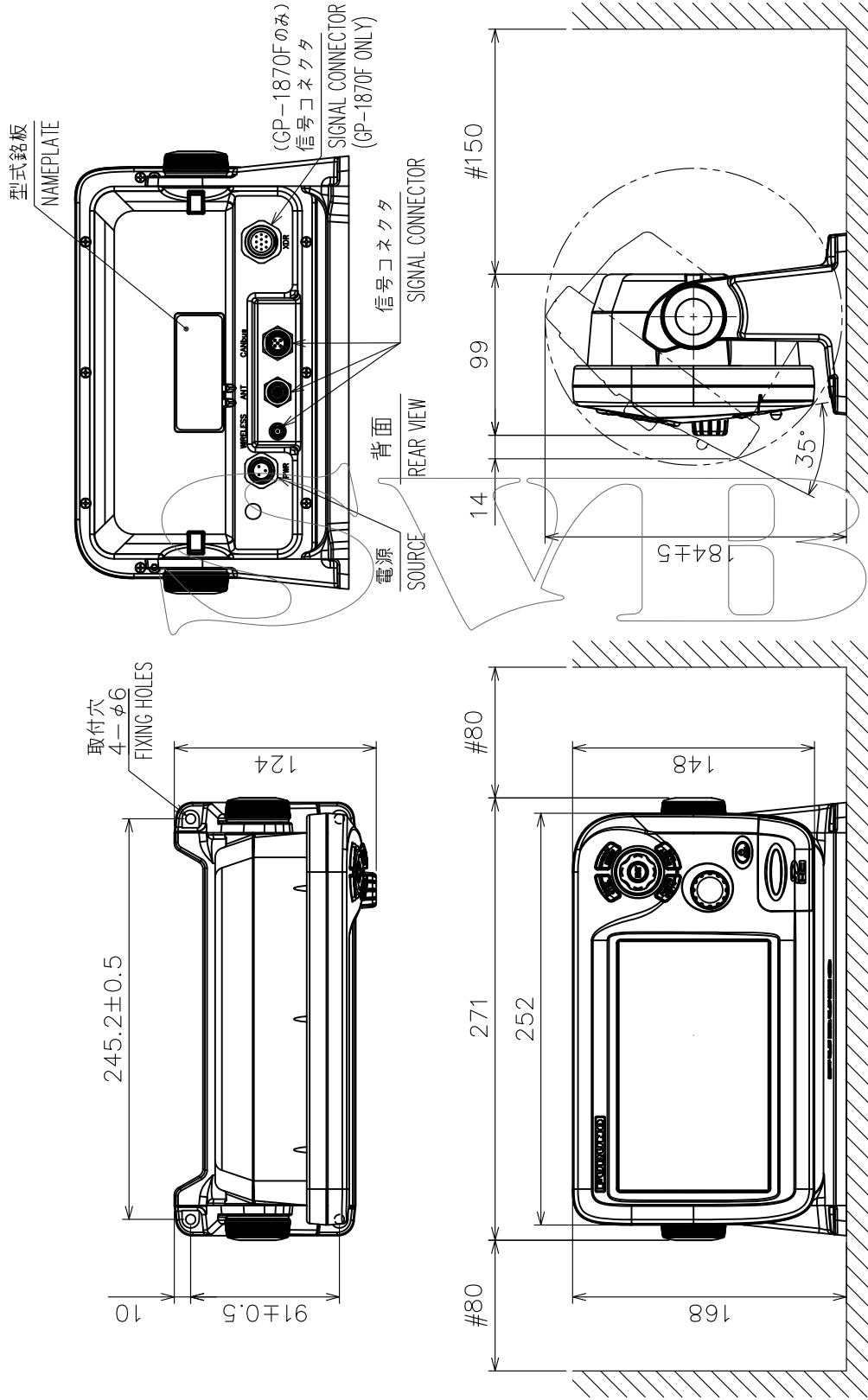

注記

- 1) 指定外の寸法公差は表1による。
- 2) #印寸法は最小サービスクリアランスとする。
- 3) 取付用ネジはトラスタップピンネジ呼び径5を使用のこと。

NOTE

1. TABLE 1 INDICATES TOLERANCE OF DIMENSIONS WHICH IS NOT SPECIFIED.
2. #: MINIMUM SERVICE CLEARANCE.
3. USE TAPPING SCREWS $\phi 4.8 \times 22$ FOR FIXING THE UNIT.

DRAWN	4/Apr/2012	T.YAMASAKI	TITLE	GP-1870/1870F
CHECKED	4/Apr/2012	H.MAKI	名称	指示部 (卓上装備)
APPROVED	6/Apr/2012	H. Maki	外寸図	
SCALE	1/4	質量表参照 SEE TABLE 2	NAME	DISPLAY UNIT (TABLETOP MOUNT)
DWG.No.	C4479-G01-A	REF.No.	14-079-102G-1	OUTLINE DRAWING

表1 TABLE 1

寸法区分 (mm) DIMENSION	公差 (mm) TOLERANCE
L ≤ 50	±1.5
50 < L ≤ 100	±2.5
100 < L ≤ 500	±3

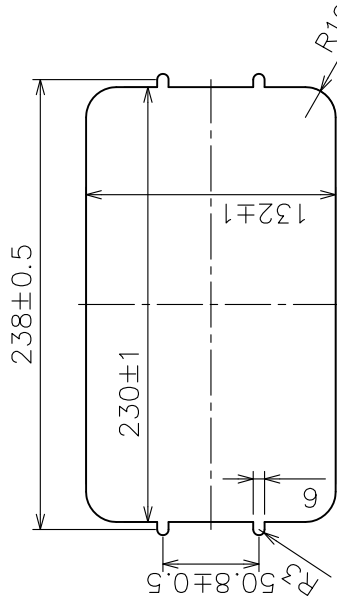
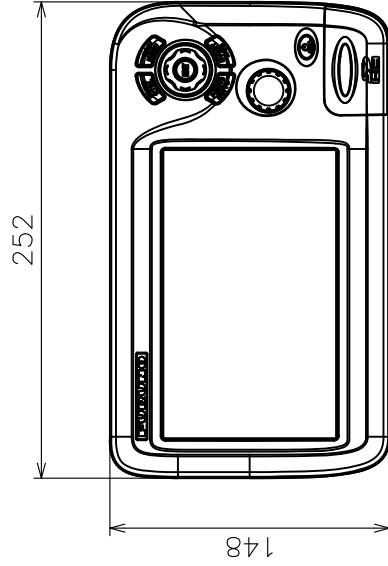
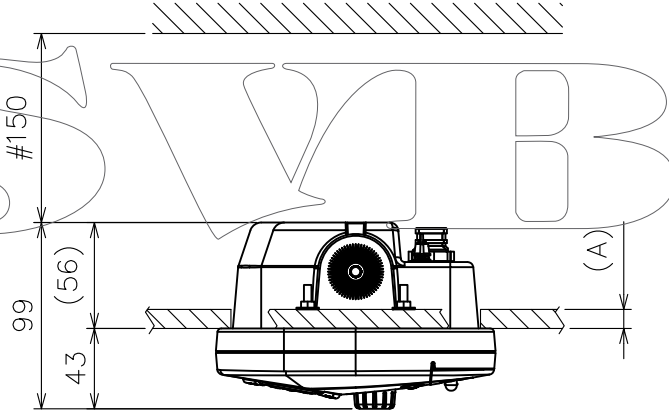
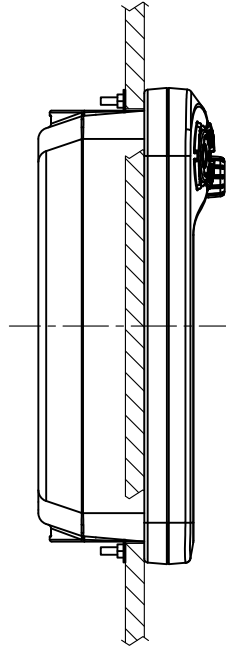

取付穴寸法
CUTOOUT DIMENSIONS

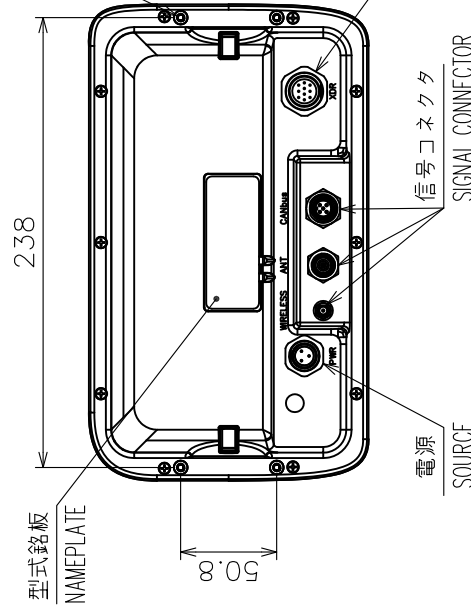

- 注記
- 1) 指定外の寸法公差は表1による。
 - 2) #印寸法は最小サービス空間寸法とする。
 - 3) 壁の厚さ(A)は $5 \leq A \leq 18$ とする。
取付にはM4×30寸切ボルト、M4座金・ナットを使用すること。
筐体にはネジ部を8mm以上入れないこと。

表2 TABLE 2

型式	MODEL	質量	MASS(kg±10%)
GP-1870		1.3	
GP-1870F		1.5	

NOTE

1. TABLE 1 INDICATES TOLERANCE OF DIMENSIONS WHICH IS NOT SPECIFIED.
2. #: MINIMUM SERVICE CLEARANCE.
3. USE STUD BOLT M4x30, M4 WASHER/NUT FOR FIXING THE UNIT.
DO NOT SCREW INTO THE UNIT 8mm OR MORE.

DRAWN	4/Apr/2012	T.YAMASAKI	TITLE	GP-1870/1870F
CHECKED	4/Apr/2012	H.MAKI	名称	指示部 (埋込装備)
APPROVED	6/Apr/2012	H. Maki	NAME	外寸図
SCALE	1/4	MASS 表を参照 SEE TABLE 2	REF.No.	14-079-103G-1
DMC.No.	C4479-G02-A		OUTLINE DRAWING	

FURUNO

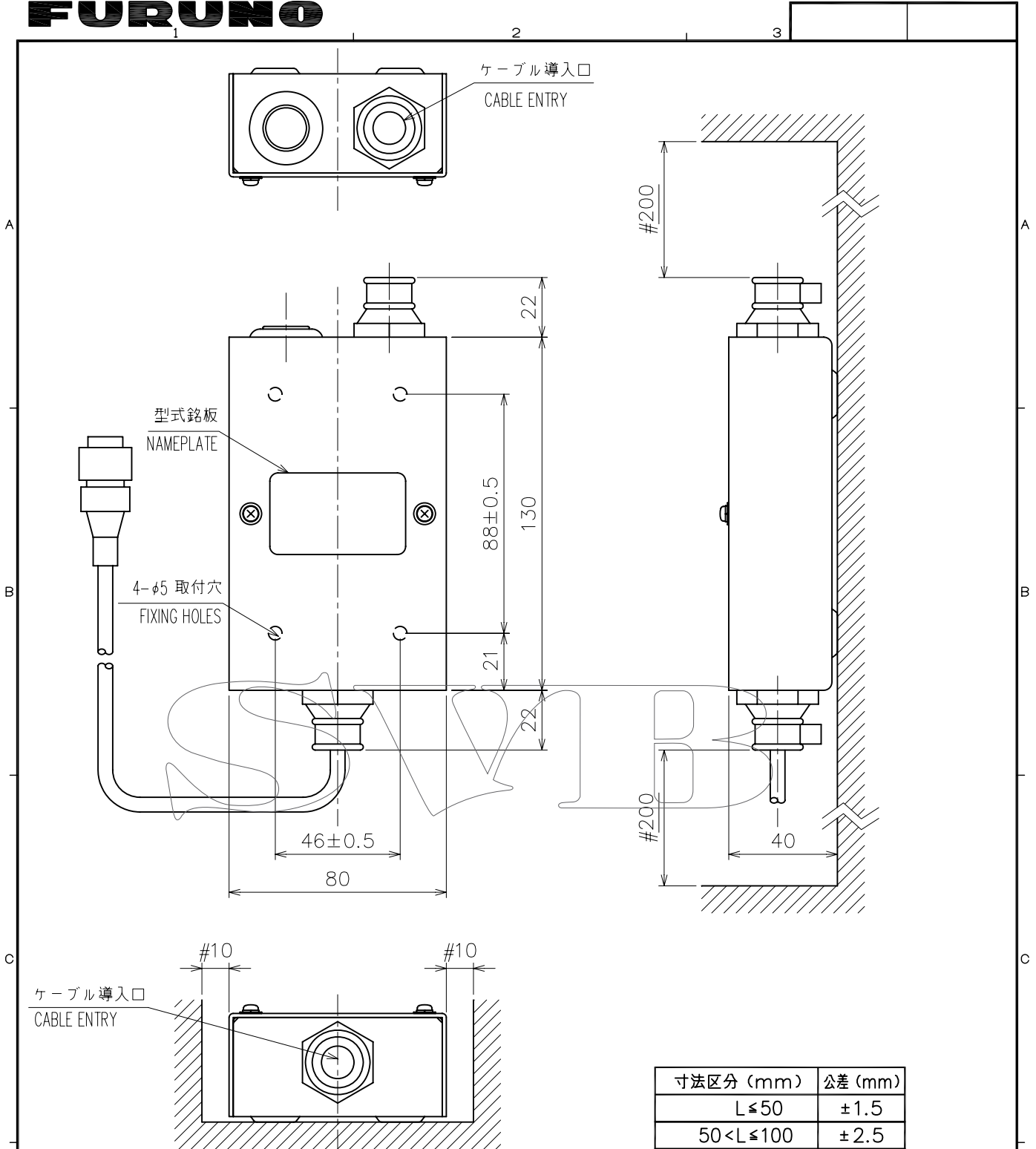

- 注 記
- 1) #印寸法は最小サービス空間寸法とする。
 - 2) 指定外の寸法公差は表1による。
 - 3) 質量にケーブルを含む。

- NOTE
1. #: MINIMUM SERVICE CLEARANCE.
 2. TABLE 1 INDICATES TOLERANCE OF DIMENSIONS WHICH IS NOT SPECIFIED.
 3. MASS INCLUDES CABLE.

DRAWN	Jun. 16, '06 E. MIYOSHI	TITLE	MB-1100
CHECKED	TAKAHASHI. T	名称	分配箱
APPROVED	Y. Hatai	FCV-585	外寸図
SCALE	1/2	MASS	0.65 ^{±10%} kg
DWG.No.	C2375-G03-B	REF.No.	02-155-200G-1
		NAME	MATCHING BOX
			OUTLINE DRAWING

空中線部 ANTENNA UNIT
GPA-017S

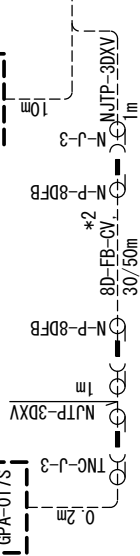

指示部 DISPLAY UNIT
GP-1670F/1870F



ジャンクションボックス JUNCTION BOX
FI-5002 *2
または OR
データ変換器 DATA CONVERTER
IF-1MMEA2K2 *2

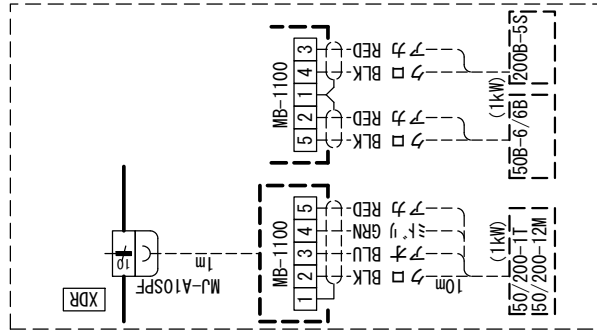
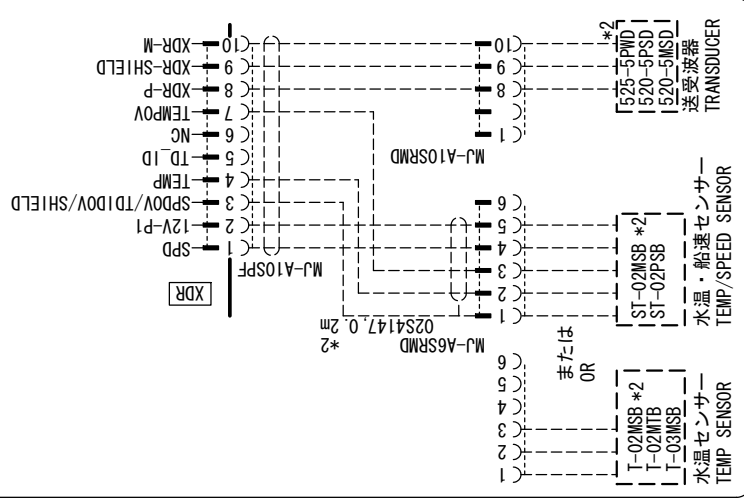
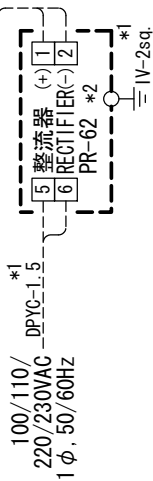
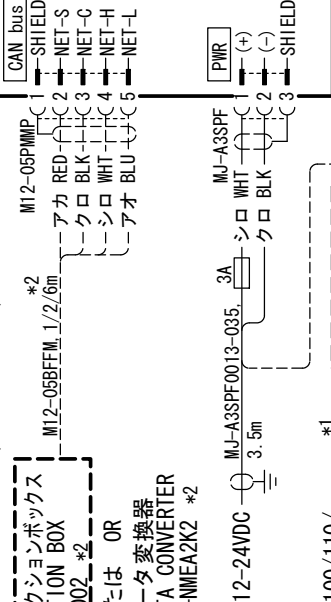

注記

- * 1) 造船所手配。
- * 2) オプション。

NOTE

- * 1: SHIPYARD SUPPLY.
- * 2: OPTION.

DRAWN	21/Mar/2012	T. YAMASAKI	TITLE	GP-1670F/1870F
CHECKED	21/Mar/2012	H. MAKI	名称	カラーGPSプロッタ魚探
APPROVED	22/Mar/2012	Y. NISHIYAMA	相互結線図	
SCALE	1/MASS	kg	NAME	GPS PLOTTER/SOUNDER
DWG. No.	04477-001-A	REF. No.		INTERCONNECTION DIAGRAM

INDEX

Numerics

- 2D perspective display 6-5
- 3D display
 - description 6-6
 - exaggeration 6-7
 - tilt 6-7

A

- ACCU-FISH™
 - activating, deactivating 7-17
 - considerations 7-16
 - fish size correction 7-17
- Acoustic speed calibration 7-21
- AIS
 - activation range 10-2
 - CPA and TCPA alarms 10-2
 - symbols 10-1
 - target information 10-2

Alarms

- anchor 8-5
- arrival 8-2
- audio alarm 8-2
- black water tank 8-6
- depth 8-4
- fuel tank 8-6
- menu 8-1
- shear 8-4
- speed 8-5
- temperature 8-3
- trip 8-5
- water tank 8-6
- XTE 8-3
- Alarms menu 8-1
- Anchor alarm 8-5
- Arrival alarm 8-2
- A-scope display 7-5
- Audio alarm 8-2
- Auto course-up 1-19

B

- Background color (fish finder) 7-19
- Black water tank alarm 8-6
- Bottom discrimination display 7-6
- Bottom level 7-21
- Bottom lock display 7-4
- Bottom type alarm 7-14
- Bottom zoom display 7-4
- Brilliance 1-6

C

- Chart scrolling 1-19
- Clutter 7-10
- Color bar 7-19
- Color erase 7-12
- Context-sensitive menus 1-22

- Controls 1-1
- Course-up 1-18
- CPA alarm 10-2
- Cursor 1-9

D

- DAM report 12-6
- Defaults restore 12-5
- Depth alarm 8-4
- Depth indication 7-21
- Display range 1-18
- Display range (fish finder) 7-9
- Draft 7-21
- DSC message 10-3
- Dual frequency display 7-3

E

- Easy routing
 - description 4-3
 - error messages 4-6
 - safe values for 4-4
- Echo offset 7-20
- Engine display 10-7

F

- Fish alarm 7-14
- Fish alarm (b/f) 7-14
- Fish size alarm 7-14
- Fuel tank alarm 8-6
- Fuse replacement 12-2

G

- Gain adjustment
 - automatic 7-8
 - manual 7-10
- General menu 11-1
- GPS status display 12-4

H

- Head-up 1-18
- Highway display 1-14
- Home screen
 - active screen 1-11
 - customizing 1-12
 - description of displays 1-14
 - display selection 1-11
- HOME/CTRL key 1-11

I

- Input data 10-5
- Interference 7-12

L

- License information 12-6

M

- Maintenance 12-1
- Maps

INDEX

- chart display6-2
- chart language6-2
- icon size6-1
- map configuration.....6-2
- nav aids presentation6-1
- place name size6-1
- Marker zoom display7-5
- Memory cards
 - care1-2
 - deleting files from9-3
 - ejecting.....1-2, 9-2
 - importing data from9-3
 - initializing.....9-1
 - rename files on.....9-2
 - saving data to.....9-2
 - screen9-1
 - tested1-3
- Memory clear12-5
- Menu overview.....1-20
- Menu tree.....AP-1
- MOB (Man Overboard)1-24
- N**
- Navigation
 - quick point.....5-1
 - route.....5-2
 - saved point.....5-2
- Navigation data boxes1-10
- North-up1-18
- O**
- Object information.....1-21
- Orientation mode1-18
- Output data10-6
- P**
- Picture advance speed7-11
- Plotter menu.....11-2
- Points
 - deleting.....3-6
 - entering, at current position.....3-1
 - entering, at cursor position.....3-2
 - entering, from points list.....3-3
 - entering, manually.....3-3
 - filtering.....3-6
 - information3-4
 - moving.....3-4
 - searching on points list.....3-5
 - sorting on points list3-5
 - visibility.....3-5
- Power on/off.....1-6
- POWER/BRILL key1-6
- Q**
- Quick point5-1
- R**
- RotoKey™1-5
- Routes
 - calculator.....4-10
 - connect two routes4-11
 - creating, from RotoKey menu4-1
 - creating, from routes list.....4-2
 - creating, with easy routing4-3
 - deleting.....4-12
 - deleting points from.....4-7
 - displaying4-11
 - editing.....4-9
 - extending.....4-6
 - information4-11
 - inserting points4-7
 - moving points4-7
 - renaming4-12
 - report.....4-10
 - restarting navigation.....5-4
 - reverse order navigation5-4
 - selecting for navigation5-2
 - skipping a leg5-4
 - stopping following of.....5-4
- Routes list
 - displaying4-8
 - functions available with4-9
- S**
- Satellite photo overlay.....6-8
- Screenshots
 - copying from internal memory to
 - a memory card9-4
 - deleting.....9-5
 - selecting source of9-4
 - taking.....1-24
- Shear alarm8-4
- Shift.....7-9
- Single frequency display7-3
- Smoothing7-21
- Soft controls1-5
- Speed alarm.....8-5
- Speed calibration7-21
- Stopwatch10-4
- System configuration.....xi
- System information12-6
- System menu11-3
- T**
- Tank level display.....1-15
- TCPA alarm.....10-2
- Temperature alarm.....8-3
- Temperature calibration7-21
- Temperature graph display1-15
- Tide & celestial display.....1-14
- Tide height information.....1-25
- Tide stream information1-26
- Timer10-4
- Track
 - color2-2
 - color by water temperature2-2
 - deleting by color2-3
 - hiding, showing all track2-1
 - hiding, showing by color.....2-2
 - information2-3

recording interval.....	2-1
recording method	2-1
stopping recording of.....	2-1
Transmission power	7-20
Trip alarm	8-5
Troubleshooting	12-2
TVG.....	7-13
V	
VRM	7-13
W	
Water tank alarm.....	8-6
Water temperature graph	7-18
White line	7-14
White marker.....	7-14
Wind meter display.....	1-15
X	
XTE alarm	8-3
Z	
Zero line	7-22
range	7-19
rejection.....	7-19

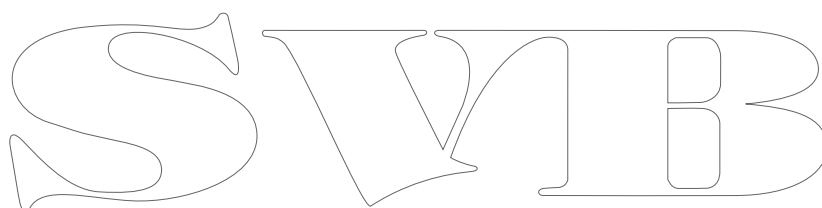
The image shows a large, stylized outline logo for 'SWIB'. The letters are bold and have a decorative, slightly calligraphic feel. The 'S' is on the left, followed by 'W', 'I', and 'B' on the right. The logo is composed of thin black lines on a white background.

FURUNO Worldwide Warranty for Pleasure Boats (Except North America)

This warranty is valid for products manufactured by Furuno Electric Co. (hereafter FURUNO) and installed on a pleasure boat. Any web based purchases that are imported into other countries by anyone other than a FURUNO certified dealer may not comply with local standards. FURUNO strongly recommends against importing these products from international websites as the imported product may not work correctly and may interfere with other electronic devices. The imported product may also be in breach of the local laws and mandated technical requirements. Products imported into other countries as described previously shall not be eligible for local warranty service.

For products purchased outside of your country please contact the national distributor of Furuno products in the country where purchased.

This warranty is in addition to the customer's statutory legal rights.

1. Terms and Conditions of Warranty

FURUNO guarantees that each new FURUNO product is the result of quality materials and workmanship. The warranty is valid for a period of 2 years (24 months) from the date of the invoice, or the date of commissioning of the product by the installing certified dealer.

2. FURUNO Standard Warranty

The FURUNO standard warranty covers spare parts and labour costs associated with a warranty claim, provided that the product is returned to a FURUNO national distributor by prepaid carrier.

The FURUNO standard warranty includes:

- Repair at a FURUNO national distributor
- All spare parts for the repair
- Cost for economical shipment to customer

3. FURUNO Onboard Warranty

If the product was installed/commissioned and registered by a certified FURUNO dealer, the customer has the right to the onboard warranty.

The FURUNO onboard warranty includes

- Free shipping of the necessary parts
- Labour: Normal working hours only
- Travel time: Up to a maximum of two (2) hours
- Travel distance: Up to a maximum of one hundred and sixty (160) KM by car for the complete journey

4. Warranty Registration

For the Standard Warranty - presentation of product with serial number (8 digits serial number, 1234-5678) is sufficient. Otherwise, the invoice with serial number, name and stamp of the dealer and date of purchase is shown.

For the Onboard Warranty your FURUNO certified dealer will take care of all registrations.

5. Warranty Claims

For the Standard Warranty - simply send the defective product together with the invoice to a FURUNO national distributor. For the Onboard Warranty - contact a FURUNO national distributor or a certified dealer. Give the product's serial number and describe the problem as accurately as possible.

Warranty repairs carried out by companies/persons other than a FURUNO national distributor or a certified dealer is not covered by this warranty.

6. Warranty Limitations

When a claim is made, FURUNO has a right to choose whether to repair the product or replace it.

The FURUNO warranty is only valid if the product was correctly installed and used. Therefore, it is necessary for the customer to comply with the instructions in the handbook. Problems which result from not complying with the instruction manual are not covered by the warranty.

FURUNO is not liable for any damage caused to the vessel by using a FURUNO product.

The following are excluded from this warranty:

- a. Second-hand product
- b. Underwater unit such as transducer and hull unit
- c. Routine maintenance, alignment and calibration services.
- d. Replacement of consumable parts such as fuses, lamps, recording papers, drive belts, cables, protective covers and batteries.
- e. Magnetron and MIC with more than 1000 transmitting hours or older than 12 months, whichever comes first.
- f. Costs associated with the replacement of a transducer (e.g. Crane, docking or diver etc.).
- g. Sea trial, test and evaluation or other demonstrations.
- h. Products repaired or altered by anyone other than the FURUNO national distributor or an authorized dealer.
- i. Products on which the serial number is altered, defaced or removed.
- j. Problems resulting from an accident, negligence, misuse, improper installation, vandalism or water penetration.
- k. Damage resulting from a force majeure or other natural catastrophe or calamity.
- l. Damage from shipping or transit.
- m. Software updates, except when deemed necessary and warrantable by FURUNO.
- n. Overtime, extra labour outside of normal hours such as weekend/holiday, and travel costs above the 160 KM allowance
- o. Operator familiarization and orientation.

FURUNO Electric Company, March 1, 2011

FURUNO Warranty for North America

FURUNO U.S.A., Limited Warranty provides a twenty-four (24) months LABOR and twenty-four (24) months PARTS warranty on products from the date of installation or purchase by the original owner. Products or components that are represented as being waterproof are guaranteed to be waterproof only for, and within the limits, of the warranty period stated above. The warranty start date may not exceed eighteen (18) months from the original date of purchase by dealer from Furuno USA and applies to new equipment installed and operated in accordance with Furuno USA's published instructions.

Magnetrons and Microwave devices will be warranted for a period of 12 months from date of original equipment installation.

Furuno U.S.A., Inc. warrants each new product to be of sound material and workmanship and through its authorized dealer will exchange any parts proven to be defective in material or workmanship under normal use at no charge for a period of 24 months from the date of installation or purchase.

Furuno U.S.A., Inc., through an authorized Furuno dealer will provide labor at no cost to replace defective parts, exclusive of routine maintenance or normal adjustments, for a period of 24 months from installation date provided the work is done by Furuno U.S.A., Inc. or an AUTHORIZED Furuno dealer during normal shop hours and within a radius of 50 miles of the shop location.

A suitable proof of purchase showing date of purchase, or installation certification must be available to Furuno U.S.A., Inc., or its authorized dealer at the time of request for warranty service.

This warranty is valid for installation of products manufactured by Furuno Electric Co. (hereafter FURUNO). Any purchases from brick and mortar or web-based resellers that are imported into other countries by anyone other than a FURUNO certified dealer, agent or subsidiary may not comply with local standards. FURUNO strongly recommends against importing these products from international websites or other resellers, as the imported product may not work correctly and may interfere with other electronic devices. The imported product may also be in breach of the local laws and mandated technical requirements. Products imported into other countries, as described previously, shall not be eligible for local warranty service.

For products purchased outside of your country please contact the national distributor of Furuno products in the country where purchased.

WARRANTY REGISTRATION AND INFORMATION

To register your product for warranty, as well as see the complete warranty guidelines and limitations, please visit www.furunousa.com and click on "Support". In order to expedite repairs, warranty service on Furuno equipment is provided through its authorized dealer network. If this is not possible or practical, please contact Furuno U.S.A., Inc. to arrange warranty service.

FURUNO U.S.A., INC.
Attention: Service Coordinator
4400 N.W. Pacific Rim Boulevard
Camas, WA 98607-9408
Telephone: (360) 834-9300
FAX: (360) 834-9400

Furuno U.S.A., Inc. is proud to supply you with the highest quality in Marine Electronics. We know you had several choices when making your selection of equipment, and from everyone at Furuno we thank you. Furuno takes great pride in customer service.

Declaration of Conformity



We **FURUNO ELECTRIC CO., LTD.**

(Manufacturer)

9-52 Ashihara-Cho, Nishinomiya City, 662-8580, Hyogo, Japan

(Address)

declare under our sole responsibility that the product

GPS PLOTTER GP-1670 and GPS PLOTTER/SOUNDER GP-1670F

(Model name, type number)

is in conformity with the essential requirements as described in the Directive 1999/5/EC of the European Parliament and of the Council of 9 March 1999 on radio equipment and telecommunications terminal equipment (R&TTE Directive) and satisfies all the technical regulations applicable to the product within this Directive

IEC 60945 Ed.4.0: 2002 EMC related items	ETSI EN 301 489-1 V1.8.1: 2008 EMC related items
IEC 60950-1 Ed.2.0: 2005	ETSI EN 301 489-3 V1.4.1: 2002 EMC related items
IEC 62311 Ed.1.0: 2007 EMC related items	ETSI EN 301 489-19 V1.2.1: 2002 EMC related items
IEC 60529 Ed.2.1: 2001	ETSI EN 300 440-2 V1.4.1: 2010 Spurious related items
	ETSI EN 300 440-1 V1.6.1: 2010 Spurious related items

(title and/or number and date of issue of the standard(s) or other normative document(s))

For assessment, see

- Test Report GSD 12962A, 12962A-S, 12962B, 12962B-S prepared by G.S.D. S.r.l., and TesLab 123030A, 123031A, 122018A prepared by TesLab s.r.l..

On behalf of Furuno Electric Co., Ltd.

Yoshitaka Shogaki
Department General Manager
Quality Assurance Department

Nishinomiya City, Japan
May 11, 2012

(Place and date of issue)

(name and signature or equivalent marking of authorized person)

Declaration of Conformity



We **FURUNO ELECTRIC CO., LTD.**

(Manufacturer)

9-52 Ashihara-Cho, Nishinomiya City, 662-8580, Hyogo, Japan

(Address)

declare under our sole responsibility that the product

GPS PLOTTER GP-1870 and GPS PLOTTER/SOUNDER GP-1870F

(Model name, type number)

are in conformity with the essential requirements as described in the Directive 1999/5/EC of the European Parliament and of the Council of 9 March 1999 on radio equipment and telecommunications terminal equipment (R&TTE Directive) and satisfies all the technical regulations applicable to the product within this Directive

IEC 60945 Ed.4.0: 2002 EMC related items	ETSI EN 301 489-1 V1.8.1: 2008 EMC related items
IEC 60950-1 Ed.2.0: 2005	ETSI EN 301 489-3 V1.4.1: 2002 EMC related items
IEC 62311 Ed.1.0: 2007 EMC related items	ETSI EN 301 489-17 V2.1.1: 2009 EMC related items
IEC 60529 Ed.2.1: 2001	ETSI EN 301 489-19 V1.2.1: 2002 EMC related items
	ETSI EN 300 328 V1.7.1: 2006 Spurious related items
	ETSI EN 300 440-2 V1.4.1: 2010 Spurious related items
	ETSI EN 300 440-1 V1.6.1: 2010 Spurious related items

(title and/or number and date of issue of the standard(s) or other normative document(s))

For assessment, see

- Test Report GSD 12962C, 12962C-S, 12962D, 12962D-S prepared by G.S.D. S.r.l., and TesLab 123032A, 123033A, 122019A prepared by TesLab s.r.l..

On behalf of Furuno Electric Co., Ltd.

Yoshitaka Shogaki
Department General Manager
Quality Assurance Department

Nishinomiya City, Japan
May 11, 2012

(Place and date of issue)

(name and signature or equivalent marking of authorized person)